

MDOT136160AY-WS	136 x 160	OLED Module
Specification		
Version: 1	Date: 16/02/2015	
Revision		
1	13/02/2015	First Issue

Display Features			Box Quantity	Weight / Display
Resolution	136 x 160			
Appearance	White on Black			
Logic Voltage	2.8V			
Interface	SPI			
Module Size	32.70 x 54.85 x 1.00mm			
Operating Temperature	-40°C ~ +80°C			
Construction	COT			

* - For full design functionality, please use this specification in conjunction with the SH1108 specification. (Provided Separately)

Display Accessories	
Part Number	Description

Optional Variants	
Appearance	Voltage



Basic Specifications

Display Specifications

- 1) Display Mode : Passive Matrix
- 2) Display Color : Monochrome (White)
- 3) Drive Duty : 1/160 Duty

Mechanical Specifications

- 1) Outline Drawing : According to the annexed outline drawing
- 2) Number of Pixels : 136 × 160
- 3) Module Size : 32.70 × 54.85 × 1.00 (mm)
- 4) Panel Size : 32.70 × 32.20 × 1.00 (mm) as "Polarizer Free"
- 5) Active Area : 27.18 × 23.1 (mm)
- 6) Pixel Pitch : 0.17 × 0.17 (mm)
- 7) Pixel Size : 0.15 × 0.15 (mm)
- 8) Weight : TBD (g) ± 10%

Memory Mapping & Pixel Construction

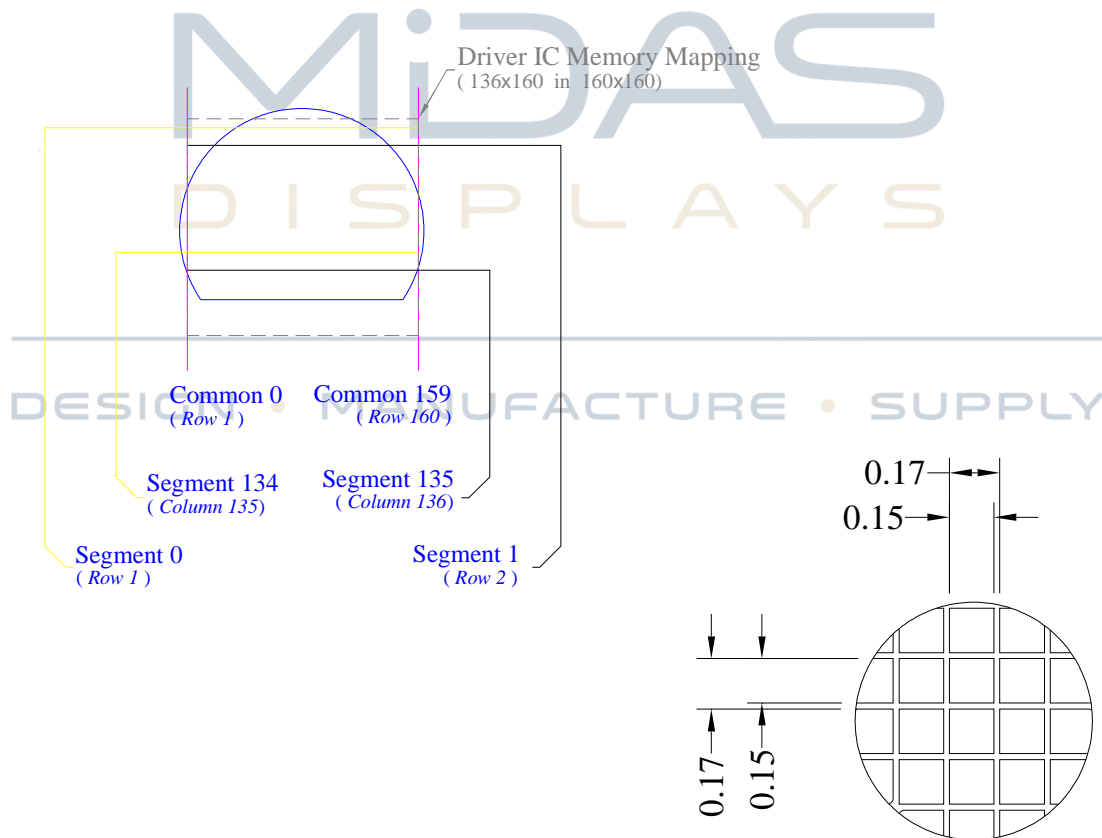

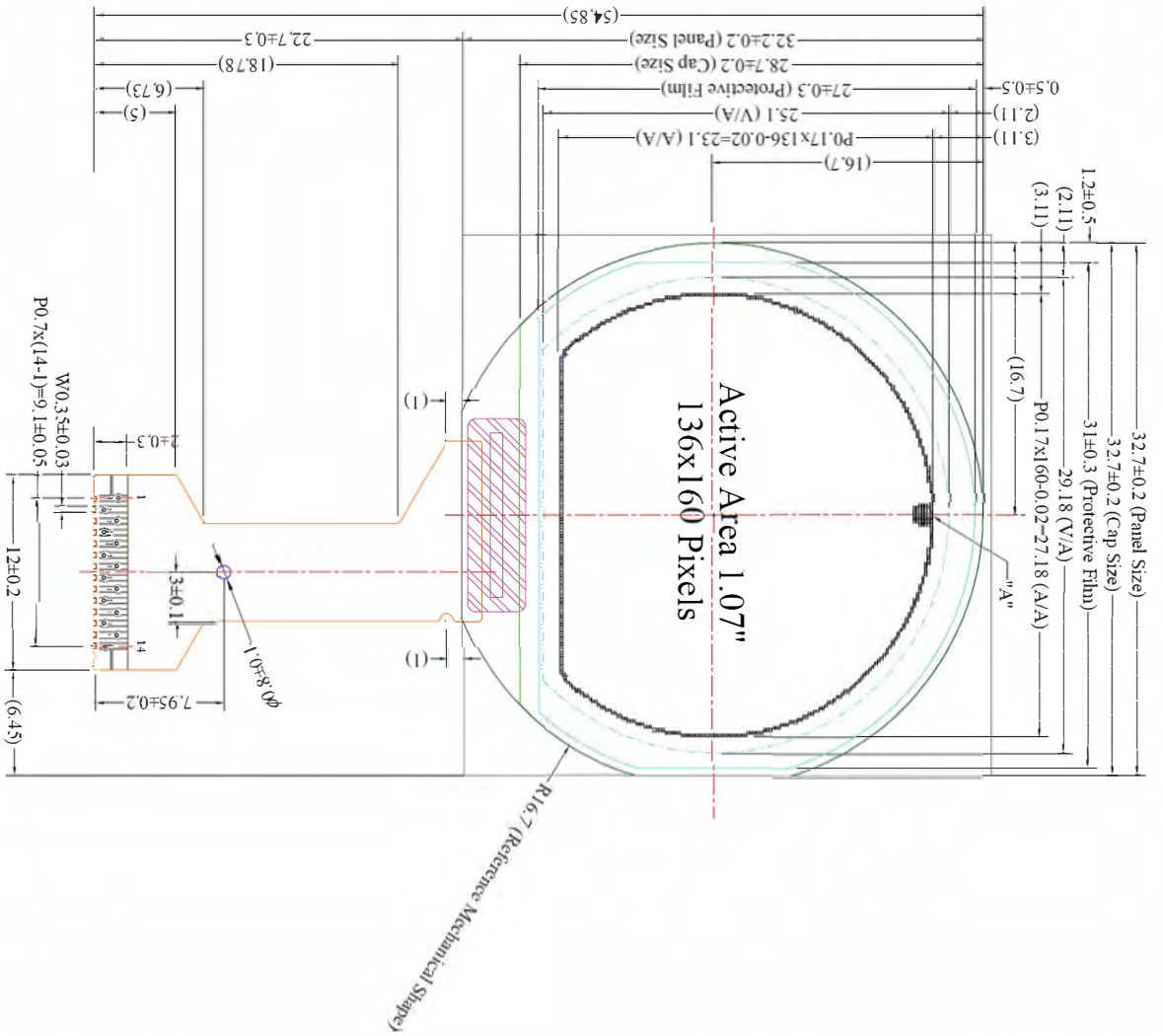

Notes:

1. Color: White
 2. Driver IC: SH1108
 3. Interface: 4-wire SPI
 4. General Tolerance: ±0.30
 5. The total thickness (1.1 Max) is without Protective Film.
- The actual assembled total thickness with above materials should be 1.2 Max

Pin	Symbol
1	GND
2	VPP
3	VSL
4	VSEGM
5	VCONH
6	GND
7	VDD
8	IREF
9	CSB
10	RESB
11	A0
12	SCL
13	SI
14	GND

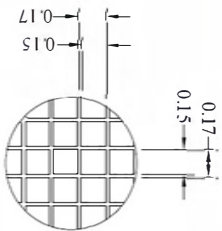
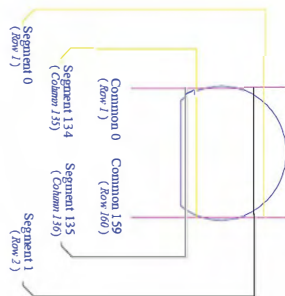
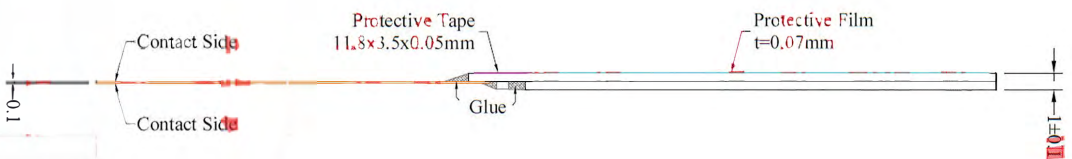

Pin Definition

Pin Number	Symbol	I/O	Function
Power Supply			
7	VDD	P	Power Supply for Logic This is a voltage supply pin. It must be connected to external source.
6	GND	P	Ground of OEL System This is a ground pin. It also acts as a reference for the logic pins, the OEL driving voltages, and the analog circuits. It must be connected to external ground.
2	VPP	P	Power Supply for OEL Panel This is the most positive voltage supply pin of the chip. It must be supplied externally.
Driver			
5	VCOMH	O	Voltage Output High Level for COM Signal This pin is for the voltage output high level for COM signals. A capacitor should be connected between this pin and GND.
4	VSEGM	O	Voltage Output High Level for Segment Pre-Charge This pin is for the voltage output high level for SEG pre-charge. A capacitor should be connected between this pin and GND.
3	VSL	P	Voltage Reference of Segment This pin is segment voltage reference pin. A capacitor should be connected between this pin and GND.
8	IREF	O	Current Reference for Brightness Adjustment This pin is segment current reference pin. A resistor should be connected between this pin and GND. Set the current at 15.625 μ A maximum.
Interface			
9	CSB	I	Chip Select when CSB is pulled low.
10	RESB	I	Power Reset for Controller and Driver This pin is reset signal input. When the pin is low, initialization of the chip is executed.
11	A0	I	Data/Command Control When the pin is pulled high and serial interface mode is selected, the data at SI is treated as data. When it is pulled low, the data at SI will be transferred to the command register.
12	SCL	I	Serial Clock Input Signal The transmission of information in the bus is following a clock signal. Each transmission of data bit is taken place during a single clock period of this pin.
13	SI	I	Serial Data Input Signal This pin acts as a communication channel. The input data through SI are latched at the rising edge of SCL in the sequence of MSB first and converted to 8-bit parallel data and handled at the rising edge of last serial clock. SI is identified to display data or command by A0 bit data at the rising of first SCL.
Reserve			
1, 14	GND	-	Reserved Pin (Supporting Pin) The supporting pins can reduce the influences from stresses on the function pins. These pins must be connected to external ground as the ESD protection circuit.

Absolute Maximum Ratings

Parameter	Symbol	Min	Max	Unit	Notes
Supply Voltage for Logic	V_{DD}	-0.3	3.6	V	1, 2
Supply Voltage for Display	V_{PP}	0	10	V	1, 2
Operating Temperature	T_{OP}	-40	70	°C	
Storage Temperature	T_{STG}	-40	85	°C	
Life Time (200 cd/m ²)		20,000	-	hour	3

Note 1: All the above voltages are on the basis of "GND. = 0V".

Note 2: When this module is used beyond the above absolute maximum ratings, permanent breakage of the module may occur. Also, for normal operations, it is desirable to use this module under the conditions according to Section 3. "Optics & Electrical Characteristics". If this module is used beyond these conditions, malfunctioning of the module can occur and the reliability of the module may deteriorate.

Note 3: $V_{PP} = 12.0V$, $T_a = 25^\circ C$, 50% Checkerboard. Software configuration follows Section 4.5 Initialization. End of lifetime is specified as 50% of initial brightness reached. The average operating lifetime at room temperature is estimated by the accelerated operation at high temperature conditions.

MIDAS
DISPLAYS

DESIGN • MANUFACTURE • SUPPLY



Optics & Electrical Characteristics

Optics Characteristics

Characteristics	Symbol	Conditions	Min	Typ	Max	Unit
Brightness	L_{br}	Note 4	150	200	-	cd/m ²
C.I.E. (White)	(x) (y)	C.I.E. 1931	0.25 0.27	0.29 0.31	0.33 0.35	
Dark Room Contrast	CR		-	>10,000:1	-	
Viewing Angle			-	Free	-	degree

* Optical measurement taken at $V_{DD} = 2.8V$, $V_{PP} = 12.0V$.
Software configuration follows Section 4.5 Initialization.

DC Characteristics

Characteristics	Symbol	Conditions	Min	Typ	Max	Unit
Supply Voltage for Logic	V_{DD}		1.65	2.8	3.5	V
Supply Voltage for Display	V_{PP}	Note 4	11.5	12.0	12.5	V
High Level Input	V_{IHC}		$0.8 \times V_{DD}$	-	V_{DD}	V
Low Level Input	V_{ILC}		0	-	$0.2 \times V_{DD}$	V
High Level Output	V_{OHC}	$I_{OH} = -500\mu A$	$0.8 \times V_{DD}$	-	V_{DD}	V
Low Level Output	V_{OLC}	$I_{OL} = 500\mu A$	0	-	$0.2 \times V_{DD}$	V
Operating Current for V_{DD}	I_{DD}		-	170	250	μA
Operating Current for V_{PP}	I_{PP}	Note 5	-	10.7	13.4	mA
		Note 6	-	15.8	19.8	mA
		Note 7	-	26.6	33.3	mA
Sleep Mode Current for V_{DD}	$I_{DD, SLEEP}$		-	2	5	μA
Sleep Mode Current for V_{PP}	$I_{PP, SLEEP}$		-	1	5	μA

Note 4: Brightness (L_{br}) and Supply Voltage for Display (V_{PP}) are subject to the change of the panel characteristics and the customer's request.

Note 5: $V_{DD} = 2.8V$, $V_{PP} = 12.0V$, 30% Display Area Turn on.

Note 6: $V_{DD} = 2.8V$, $V_{PP} = 12.0V$, 50% Display Area Turn on.

Note 7: $V_{DD} = 2.8V$, $V_{PP} = 12.0V$, 100% Display Area Turn on.

* Software configuration follows Section 4.5 Initialization.

AC Characteristics

Symbol	Description	Min	Max	Unit
t_{SCYC}	Serial Clock Cycle Time	250	-	ns
t_{SAS}	Address Setup Time	150	-	ns
t_{SAH}	Address Hold Time	150	-	ns
t_{SDS}	Data Setup Time	100	-	ns
t_{SDH}	Data Hold Time	100	-	ns
t_{CSS}	Chip Select Setup Time	120	-	ns
t_{CSH}	Chip Select Hold Time	60	-	ns
t_{SLW}	Serial Clock L Pulse Width	100	-	ns
t_{SHW}	Serial Clock H Pulse Width	100	-	ns
t_R	Rise Time	-	15	ns
t_F	Fall Time	-	15	ns

* ($V_{DD} - GND = 1.65V$ to $1.8V$, $T_a = 25^\circ C$)

Symbol	Description	Min	Max	Unit
t_{SCYC}	Serial Clock Cycle Time	200	-	ns
t_{SAS}	Address Setup Time	120	-	ns
t_{SAH}	Address Hold Time	120	-	ns
t_{SDS}	Data Setup Time	80	-	ns
t_{SDH}	Data Hold Time	80	-	ns
t_{CSS}	Chip Select Setup Time	96	-	ns
t_{CSH}	Chip Select Hold Time	48	-	ns
t_{SLW}	Serial Clock L Pulse Width	80	-	ns
t_{SHW}	Serial Clock H Pulse Width	80	-	ns
t_R	Rise Time	-	12	ns
t_F	Fall Time	-	12	ns

* ($V_{DD} - GND = 1.8V$ to $3.5V$, $T_a = 25^\circ C$)

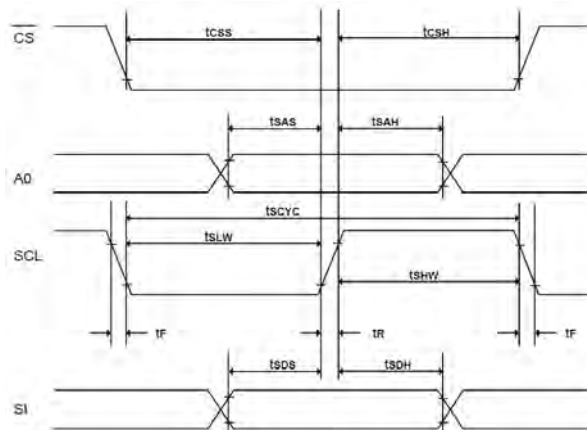

Functional Specification

Commands

Refer to the Technical Manual for the SH1108

Power down and Power up Sequence

To protect OEL panel and extend the panel life time, the driver IC power up/down routine should include a delay period between high voltage and low voltage power sources during turn on/off. It gives the OEL panel enough time to complete the action of charge and discharge before/after the operation.

Power up Sequence:

1. Power up V_{DD}
2. Send Display off command
3. Initialization
4. Clear Screen
5. Power up V_{PP}
6. Delay 100ms
(When V_{PP} is stable)
7. Send Display on command

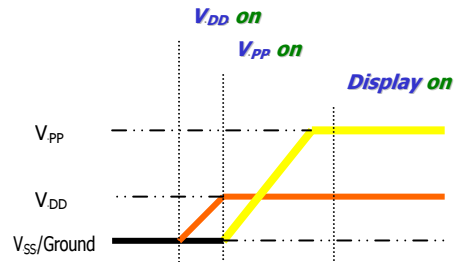

Power down Sequence:

1. Send Display off command
2. Power down V_{PP}
3. Delay 100ms
(When V_{PP} is reach 0 and panel is completely discharges)
4. Power down V_{DD}

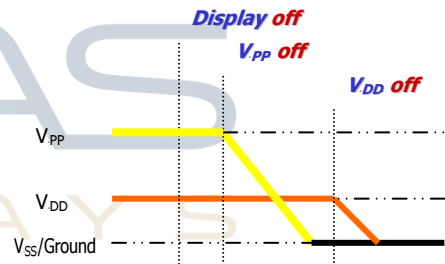

Note 8:

- 1) Since an ESD protection circuit is connected between V_{DD} and V_{PP} inside the driver IC, V_{PP} becomes lower than V_{DD} whenever V_{DD} is ON and V_{PP} is OFF.
- 2) V_{PP} should be kept float (disable) when it is OFF.
- 3) Power Pins (V_{DD} , V_{PP}) can never be pulled to ground under any circumstance.
- 4) V_{DD} should not be power down before V_{PP} power down.

Reset Circuit

When RESB input is low, the chip is initialized with the following status:

1. Display is OFF
2. 160×160 Display Mode
3. Normal segment and display data column and row address mapping (SEG0 mapped to column address 00h and COM0 mapped to row address 00h)
4. Shift register data clear in serial interface
5. Display start line is set at display RAM address 0
6. Column address counter is set at 0
7. Normal scan direction of the COM outputs
8. Contrast control register is set at 80h
9. Internal booster is selected



Peripheral Circuit

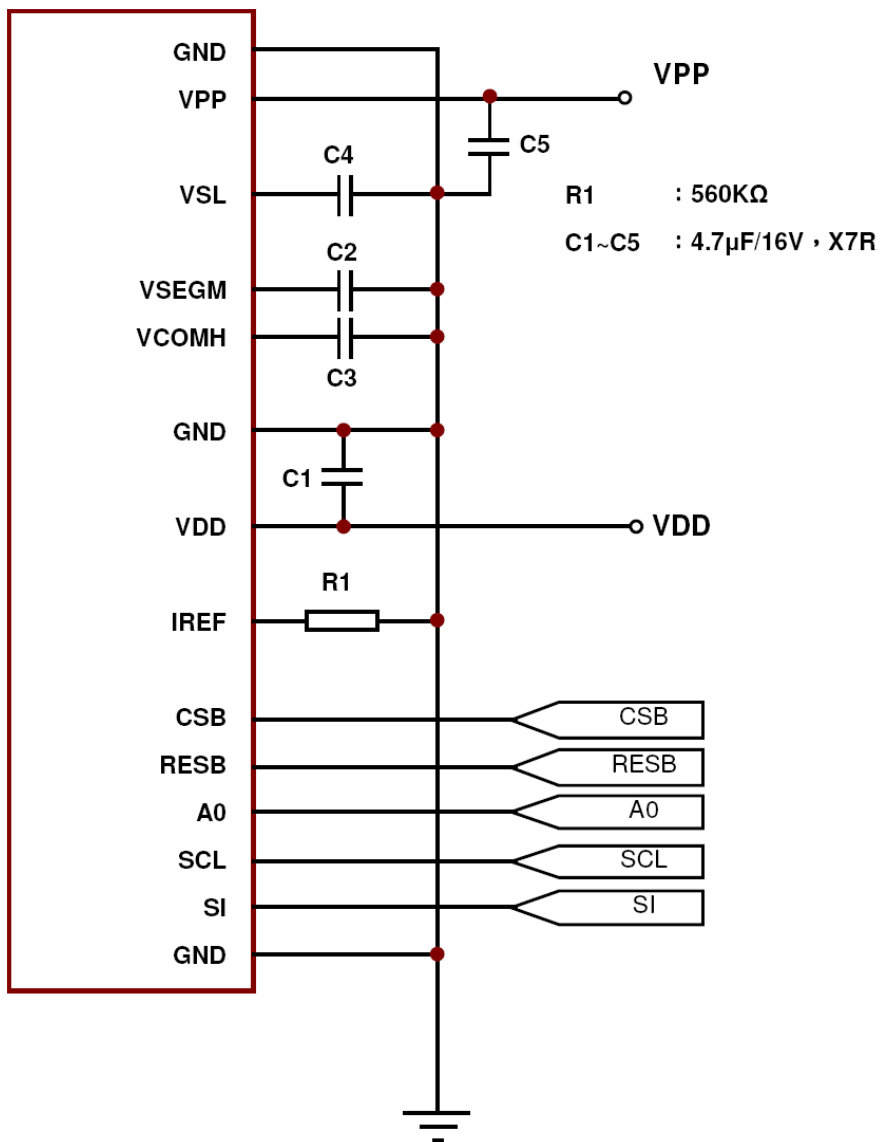

Actual Application Example

Command usage and explanation of an actual example

<Power up Sequence>

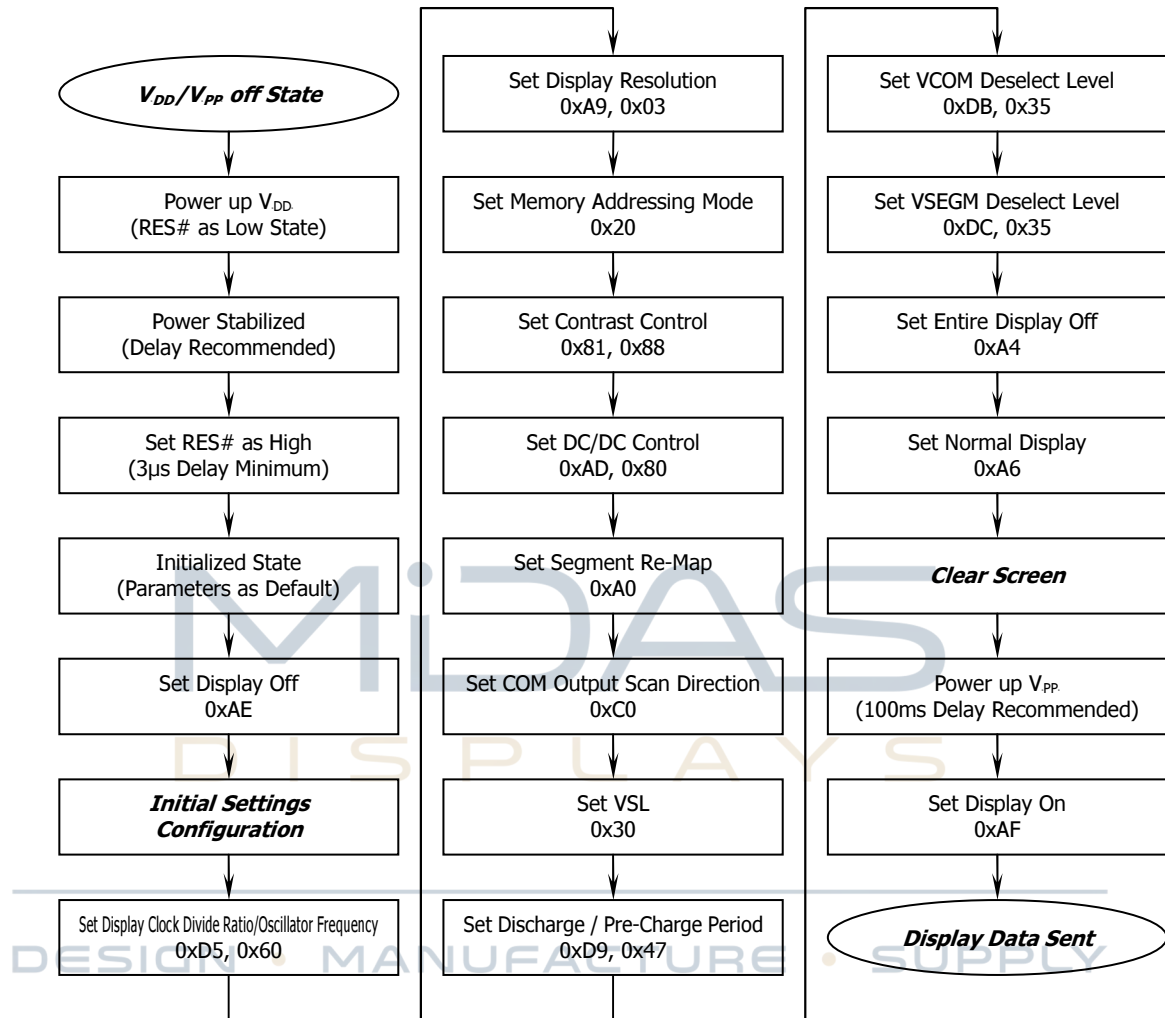

If the noise is accidentally occurred at the displaying window during the operation, please reset the display in order to recover the display function.

<Power down Sequence>

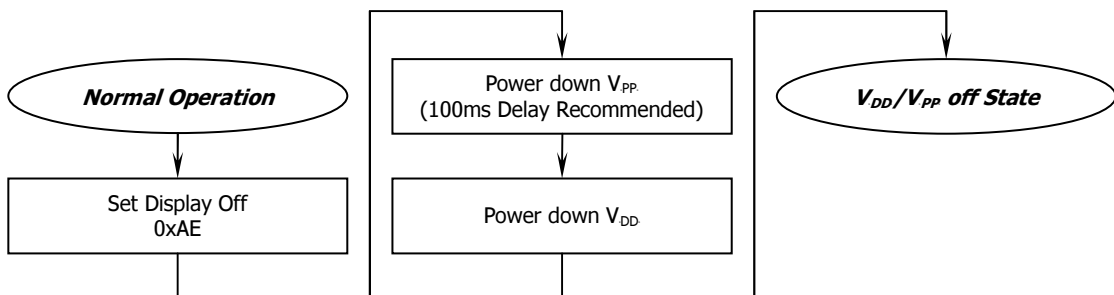

<Entering Sleep Mode>

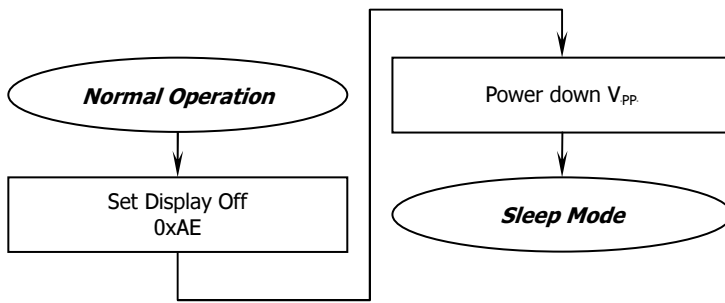

<Exiting Sleep Mode>

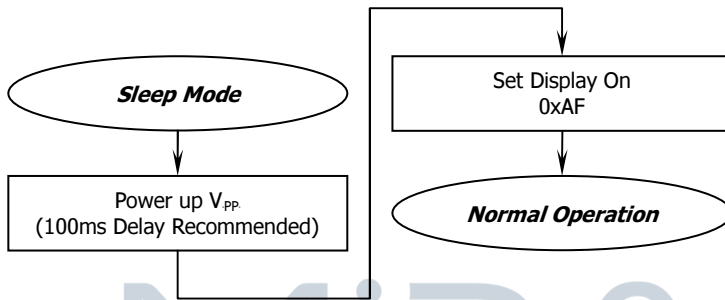

MIDAS
DISPLAYS

DESIGN • MANUFACTURE • SUPPLY



Reliability

Contents of Reliability Tests

Item	Conditions	Criteria
High Temperature Operation	70°C, 240 hrs	The operational functions work.
Low Temperature Operation	-40°C, 240 hrs	
High Temperature Storage	85°C, 240 hrs	
Low Temperature Storage	-40°C, 240 hrs	
High Temperature/Humidity Operation	60°C, 90% RH, 120 hrs	
Thermal Shock	-40°C ↔ 85°C, 24 cycles 60 mins dwell	

- * The samples used for the above tests do not include polarizer.
- * No moisture condensation is observed during tests.

Failure Check Standard

After the completion of the described reliability test, the samples were left at room temperature for 2 hrs prior to conducting the failure test at 23±5°C; 55±15% RH.

MIDAS
DISPLAYS

DESIGN • MANUFACTURE • SUPPLY



Outgoing Quality Control Specifications

Environment Required

Customer's test & measurement are required to be conducted under the following conditions:

Temperature:	23 ± 5°C
Humidity:	55 ± 15% RH
Fluorescent Lamp:	30W
Distance between the Panel & Lamp:	≥ 50cm
Distance between the Panel & Eyes of the Inspector:	≥ 30cm
Finger glove (or finger cover) must be worn by the inspector.	
Inspection table or jig must be anti-electrostatic.	

Sampling Plan

Level II, Normal Inspection, Single Sampling, MIL-STD-105E



Criteria & Acceptable Quality Level

Partition	AQL	Definition
Major	0.65	Defects in Pattern Check (Display On)
Minor	1.0	Defects in Cosmetic Check (Display Off)

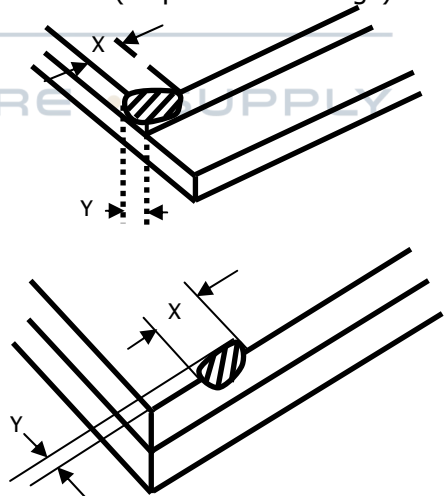
6.3.1 Cosmetic Check (Display Off) in Non-Active Area

Check Item	Classification	Criteria
Panel General Chipping	Minor	<p>X > 6 mm (Along with Edge) Y > 1 mm (Perpendicular to edge)</p> 

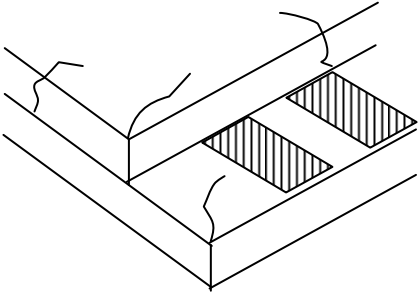
Cosmetic Check (Display Off) in Non-Active Area (Continued)

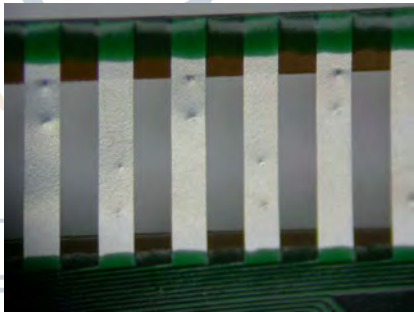
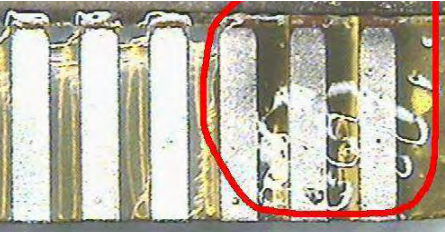
Check Item	Classification	Criteria
Panel Crack	Minor	<p>Any crack is not allowable.</p> 
Copper Exposed (Even Pin or Film)	Minor	Not Allowable by Naked Eye Inspection
Film or Trace Damage	Minor	
Terminal Lead Prober Mark	Acceptable	
Glue or Contamination on Pin (Couldn't Be Removed by Alcohol)	Minor	
Ink Marking on Back Side of panel (Exclude on Film)	Acceptable	Ignore for Any



Cosmetic Check (Display Off) in Active Area

It is recommended to execute in clear room environment (class 10k) if actual in necessary.

Check Item	Classification	Criteria
Any Dirt & Scratch on Protective Film	Acceptable	Ignore for Any
Scratches, Fiber, Line-Shape Defect (On Glass Display Side)	Minor	$W \leq 0.1$ Ignore $W > 0.1$ $L \leq 2$ $n \leq 1$ $L > 2$ $n = 0$
Dirt, Spot-Shape Defect (On Glass Display Side)	Minor	$\Phi \leq 0.1$ Ignore $0.1 < \Phi \leq 0.25$ $n \leq 1$ $0.25 < \Phi$ $n = 0$
Fingerprint, Flow Mark (On Glass Display Side)	Minor	Not Allowable

* Definition of W & L & Φ (Unit: mm): $\Phi = (a + b) / 2$

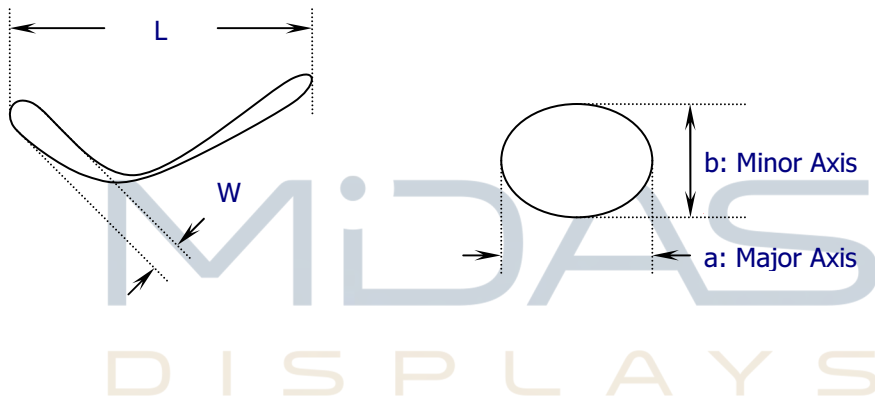

DESIGN • MANUFACTURE • SUPPLY

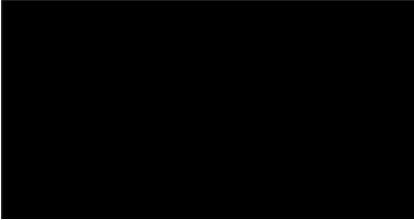
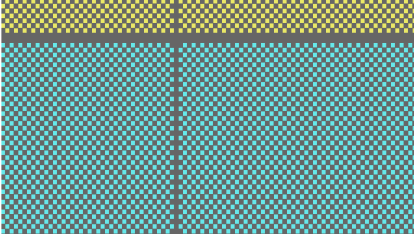
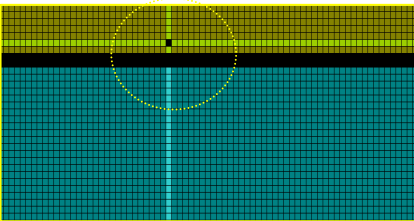
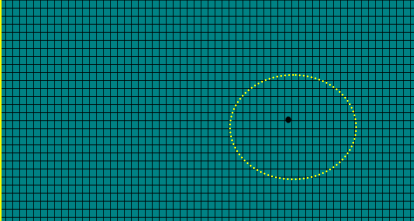
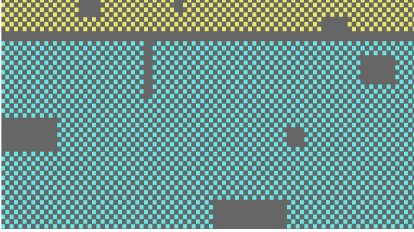
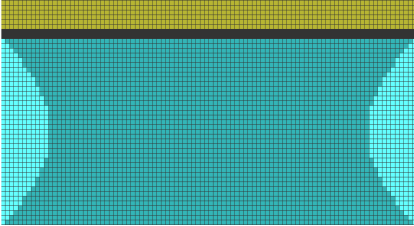

6.3.3 Pattern Check (Display On) in Active Area

Check Item	Classification	Criteria
No Display	Major	
Missing Line	Major	
Pixel Short	Major	
Darker Pixel	Major	
Wrong Display	Major	
Un-uniform	Major	



MiDAS

DISPLAYS

DESIGN • MANUFACTURE • SUPPLY

