

MC21609AB6W-FPTLW3.3-V2	2 x 16	9mm Character Height	LCD Module
<b>Specification</b>			
Version: 1		Date: 12/03/2021	
<b>Revision</b>			
1	10/03/2021	First Issue	

Display Features					
Character Count	2 x 16				
Appearance	Black on White				
Logic Voltage	3.3V				
Interface	Parallel				
Font Set	English / Japanese				
Display Mode	Transflective				
Character Height	9.66mm				
LC Type	FSTN				
Module Size	122.00 x 44.00 x 13.50 mm				
Operating Temperature	-20°C ~ +70°C				
Construction	COB			Box Quantity	Weight / Display
LED Backlight	White				

\* - For full design functionality, please use this specification in conjunction with the ST7066U + ST7065C specification. (Provided Separately)

Display Accessories	
Part Number	Description
MCCMDB-16SIL	LCD Interconnect board, can be driven from either a PC or a single Board computer with a USB output.
MCCBL1A16SLIP-16DILS-150	16 Way, Single in-line to Dual In-line connector Cable.
MCCBL1A16SLIP-16SILS-150	16 Way, Single in-line to Single In-line connector Cable.

Optional Variants		
Fonts	Appearances	Voltage
	Black on Yellow/Green White on Blue	



## FEATURES

AVAILABLE OPTIONS	CHARACTERISTICS
DISPLAY FORMAT	16 Characters by 2 Lines
POLARIZER OPTIONS	Positive Transflective
BACKLIGHT TYPE OPTIONS	Edge Type LED Backlight (Long life span version)
BACKLIGHT COLOR OPTIONS	White color
LCD PANEL OPTIONS	FSTN
VIEWING ANGLE OPTIONS	6:00 ( Bottom )
TEMPERATURE RANGE OPTIONS	-20°C ~ 70°C, Positive Voltage Driving Only
SUGGESTED DRIVING VOLTAGE	V <sub>lcm</sub> = 3.3V V <sub>led</sub> = 3.3V
SUGGESTED LED DRIVING MODE	PIN15: LED-, PIN16:LED+
CONTROLLER	ST7066U+ST7065C
FONT MAP CODE	E Version
DRIVING DUTY	1/16
DRIVING BIAS	1/5

## MECHANICAL SPECIFICATIONS

<b>OVERALL SIZE</b>	122.0W x 44.0H	mm	<b>THICKNESS</b>	max 13.5	mm
<b>VIEWING AREA</b>	99.0W x 24.0H	mm	<b>HOLE-HOLE</b>	115.0W x 37.0H	mm
<b>CHARACTER SIZE</b>	4.84W x 9.66H	mm	<b>CHARACTER PITCH</b>	1.16W x 0.68H	mm
<b>DOT SIZE</b>	0.92W x 1.10H	mm	<b>DOT PITCH</b>	0.06W x 0.06H	mm

## ABSOLUTE MAXIMUM RATINGS

ITEM	SYMBOL	CONDITION	MIN	TYP	MAX	UNIT
POWER SUPPLY ( LOGIC )	V <sub>dd</sub>	25°C	-0.3	—	7.0	V
POWER SUPPLY (LCD)	V <sub>0</sub>	25°C	V <sub>dd</sub> -13.5	—	V <sub>dd</sub> +0.3	V
INPUT VOLTAGE	V <sub>in</sub>	25°C	-0.3	—	V <sub>dd</sub> +0.3	V
OPERATING TEMPERATURE	V <sub>opr</sub>	—	-20	—	70	°C
STORAGE TEMPERATURE	V <sub>stg</sub>	—	-30	—	80	°C

## ELECTRONIC CHARACTERISTICS

ITEM	SYMBOL	CONDITION	MIN	TYP	MAX	UNIT
INPUT VOLTAGE	V <sub>lcm</sub> = V <sub>dd</sub>	—	—	3.3	—	V
SUPPLY CURRENT	I <sub>dd</sub>	V <sub>dd</sub> =3.3V	—	1.5	—	mA
DRIVING VOLTAGE FOR LCD PANEL	V <sub>lcd</sub> = (V <sub>dd</sub> - V <sub>0</sub> )	-20°C	—	—	—	V
		0°C	—	—	—	
		25°C	—	—	—	
		50°C	—	—	—	
		70°C	—	—	—	



## LCD CHARACTERISTICS

**FOR STN/FSTN TYPE LCD Panel (TA=25 °C, Vlcd=5.0V ± 0.5V)**

	ITEM	SYMBOL	CONDITION	MIN	TYP	MAX	UNIT
	VIEWING ANGLE	$\Phi 2 - \Phi 1$	K=4	40	—	—	deg
		$\theta$		60			
	CONTRAST RATIO	K	—	6	—	—	—
	RESPONSE TIME(RISE)	TR	—	—	150	250	ms
	RESPONSE TIME(FALL)	TF	—	—	150	250	ms

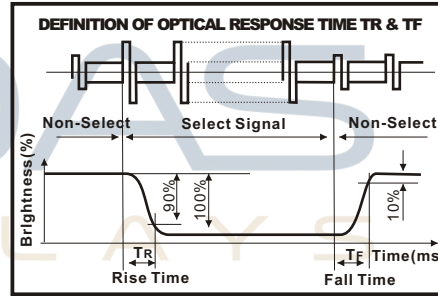
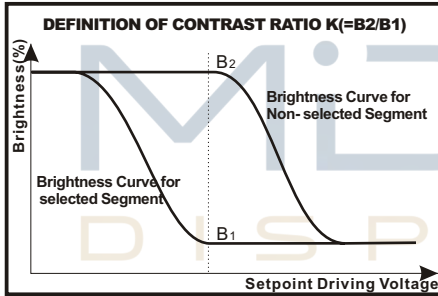
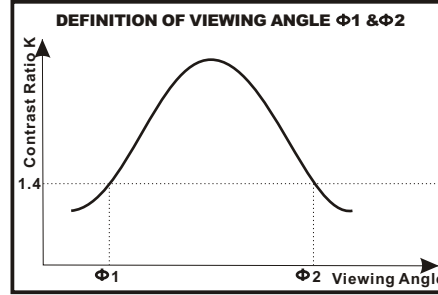
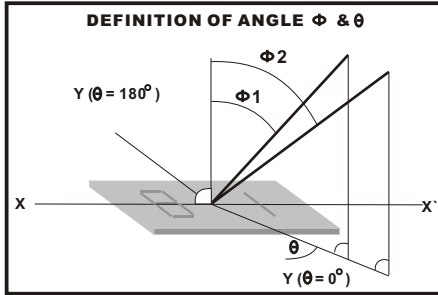

## LED CHARACTERISTICS

	ITEM	SYMBOL	CONDITION	MIN	TYP	MAX	UNIT
	LED FORWARD VOLTAGE	$V_f$	$25^\circ\text{C}$	—	3.0	—	V
	LED FORWARD CURRENT	$I_f$	$25^\circ\text{C}$	—	30	—	mA
	LED REVERSE CURRENT	$I_r$	$25^\circ\text{C}$ $V_r=5.0\text{V}$	—	—	60	$\mu\text{A}$
	LED COLOR RANGE	X coordinate	$25^\circ\text{C}$ $I_f = 30\text{mA}$	0.26	—	0.30	—
		Y coordinate		0.27	—	0.31	—
	LED BRIGHTNESS (WITHOUT LCD)	$L_v$	$25^\circ\text{C}$ $I_f = 30\text{mA}$	—	470	—	$\text{cd/m}^2$
	LED BRIGHTNESS UNIFORMITY	$L_{v\text{min}}/L_{v\text{max}}$	$25^\circ\text{C}$ $I_f = 30\text{mA}$	70	—	—	Ratio
	LED LIFE TIME	—	$25^\circ\text{C}$ $I_f = 30\text{mA}$	20K	—	—	Hours



**PIN ASSIGNMENT**

PIN	SYMBOL	DESCRIPTION	REMARKS
1	Vss	GND	
2	Vdd	Power supply for LCM	3.3V
3	NC	No connection	
4	RS	Register Select Signal	
5	R/W	Data Read / Write	
6	E	Enable Signal	
7	DB0	Data bus line	
8	DB1	Data bus line	
9	DB2	Data bus line	
10	DB3	Data bus line	
11	DB4	Data bus line	
12	DB5	Data bus line	
13	DB6	Data bus line	
14	DB7	Data bus line	
15	LED-	Power supply for BKL	
16	LED+	Power supply for BKL	3.3V

**BLOCK DIAGRAM**

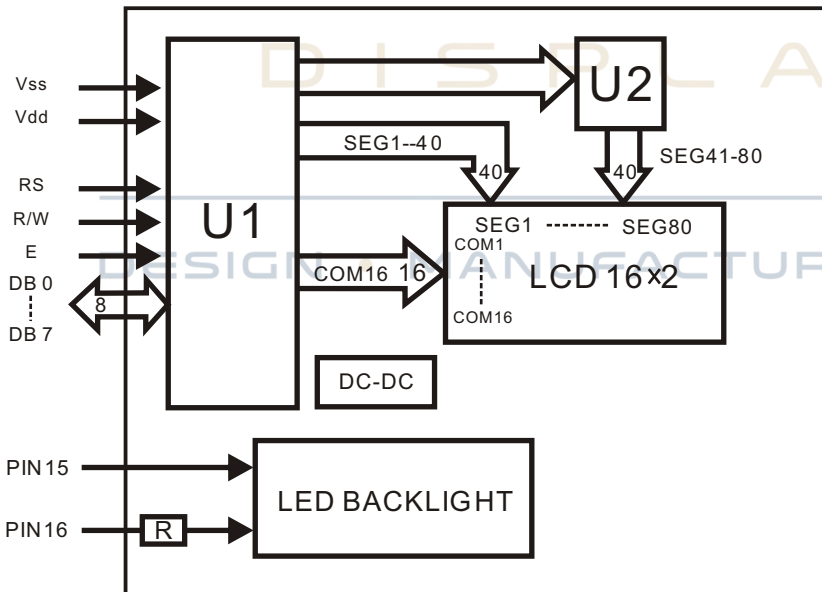

**POWER SUPPLY DIAGRAM**

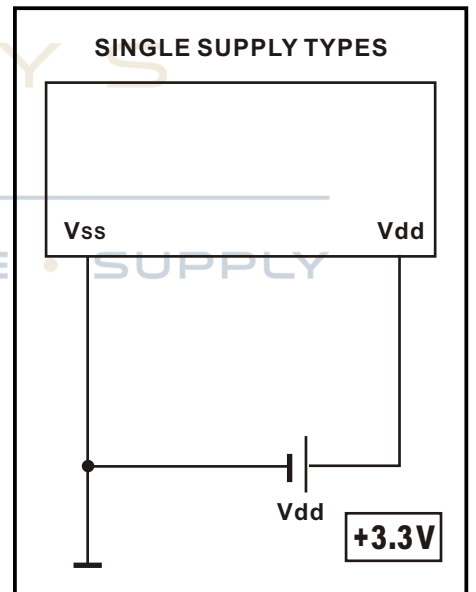

Upper 4bit Lower 4bit	LLLL	LLLH	LLHL	LLHH	LHLL	LHLH	LHHL	LHHH	HLLL	HLLH	HLHL	HLHH	HHLL	HHLH	HHHL	HHHH
LLLL	CG RAM (1)															
LLLH	(2)															
LLHL	(3)															
LLHH	(4)															
LHLL	(5)															
LHLH	(6)															
LHHL	(7)															
LHHH	(8)															
HLLL	(1)															
HLLH	(2)															
HLHL	(3)															
HLHH	(4)															
HHLL	(5)															
HHLH	(6)															
HHHL	(7)															
HHHH	(8)															



