

MDT0390A6IH-RGB	480 x 128	RGB Interface	TFT Module
Specification			
Version: 1		Date: 10/02/2022	
Revision			
1	08/02/2022	First issue	

Display Features				
Display Size	3.90"			
Resolution	480 x 128			
Orientation	Landscape			
Appearance	RGB			
Logic Voltage	3V			
Interface	RGB			
Brightness	500 cd/m ²			
Touchscreen	---			
Module Size	105.50 x 37.00 x 3.05mm			
Operating Temperature	-30°C ~ +85°C			
Pinout	40 way FFC		Box Quantity	Weight / Display
Pitch	0.5mm		---	---

DESIGN • MANUFACTURE • SUPPLY

* - For full design functionality, please use this specification in conjunction with the SC7283 specification.(Provided Separately)

Display Accessories	
Part Number	Description
MPBV6	40 Way FFC to cable and wires. Driven by any driver board that can be wired to a 1mm pitch SHDR-40V-S-B receptacle.
MDIB-11	The MDIB-11 is an HDMI to RGB converter. Ideal for connecting a range of Midas TFT displays to a Single Board Computer such as the Raspberry Pi.

Optional Variants	
Appearances	Voltage



Summary

3.9" is a color active matrix thin film transistor (TFT) liquid crystal display (LCD) that uses amorphous silicon TFT as a switching device. This TFT LCD has a 3.9 inch diagonally measured active display area with 480x128 (480 horizontal by 128 vertical pixel) resolution.

General Specifications

- Size: 3.9 inch
- Dot Matrix: 480 x RGBx128(TFT) dots
- Module dimension: 105.5(W) x 37.0(H) x 3.05(D) mm
- Active area: 95.04 x 25.34 mm
- Pixel pitch: 0.198 x 0.198 mm
- LCD type; TFT, Normally Black, Transmissive
- Viewing Angle: 80/80/80/80
- Aspect Ratio: Bar Type
- TFT Driver IC: SC7283 or equivalent
- Interface: 24-bit RGB
- Backlight Type: LED, Normally White
- With /Without TP: Without TP
- Surface: Anti-Glare

*Color tone slight changed by temperature and driving voltage.



Interface

1. LCM PIN Definition

Pin	Symbol	Function	Remark
1	VLED-	Power for LED backlight cathode	
2	VLED+	Power for LED backlight anode	
3	GND	Power ground	
4	VCC	Power voltage	
5	R0	Red data	
6	R1	Red data	
7	R2	Red data	
8	R3	Red data	
9	R4	Red data	
10	R5	Red data	
11	R6	Red data	
12	R7	Red data	
13	G0	Green data	
14	G1	Green data	
15	G2	Green data	
16	G3	Green data	
17	G4	Green data	
18	G5	Green data	
19	G6	Green data	
20	G7	Green data	
21	B0	Blue data	
22	B1	Blue data	
23	B2	Blue data	
24	B3	Blue data	
25	B4	Blue data	
26	B5	Blue data	
27	B6	Blue data	
28	B7	Blue data	
29	GND	Power ground	
30	DCLK	Pixel clock input pin	
31	DISP	DISP sets the display mode.	



		DISP	Function Description	
		L	Standby mode	
		H	Normal display mode	
32	HSYNC	Horizontal sync signal, default is negative polarity.		
33	VSYNC	Vertical sync signal, default is negative polarity.		
34	NC	No connection		
35	NC	No connection		
36	GND	Power ground		
37	NC(XR)	No connection		
38	NC(YD)	No connection		
39	NC(XL)	No connection		
40	NC(YU)	No connection		

MIDAS

DISPLAYS

DESIGN • MANUFACTURE • SUPPLY



Contour Drawing

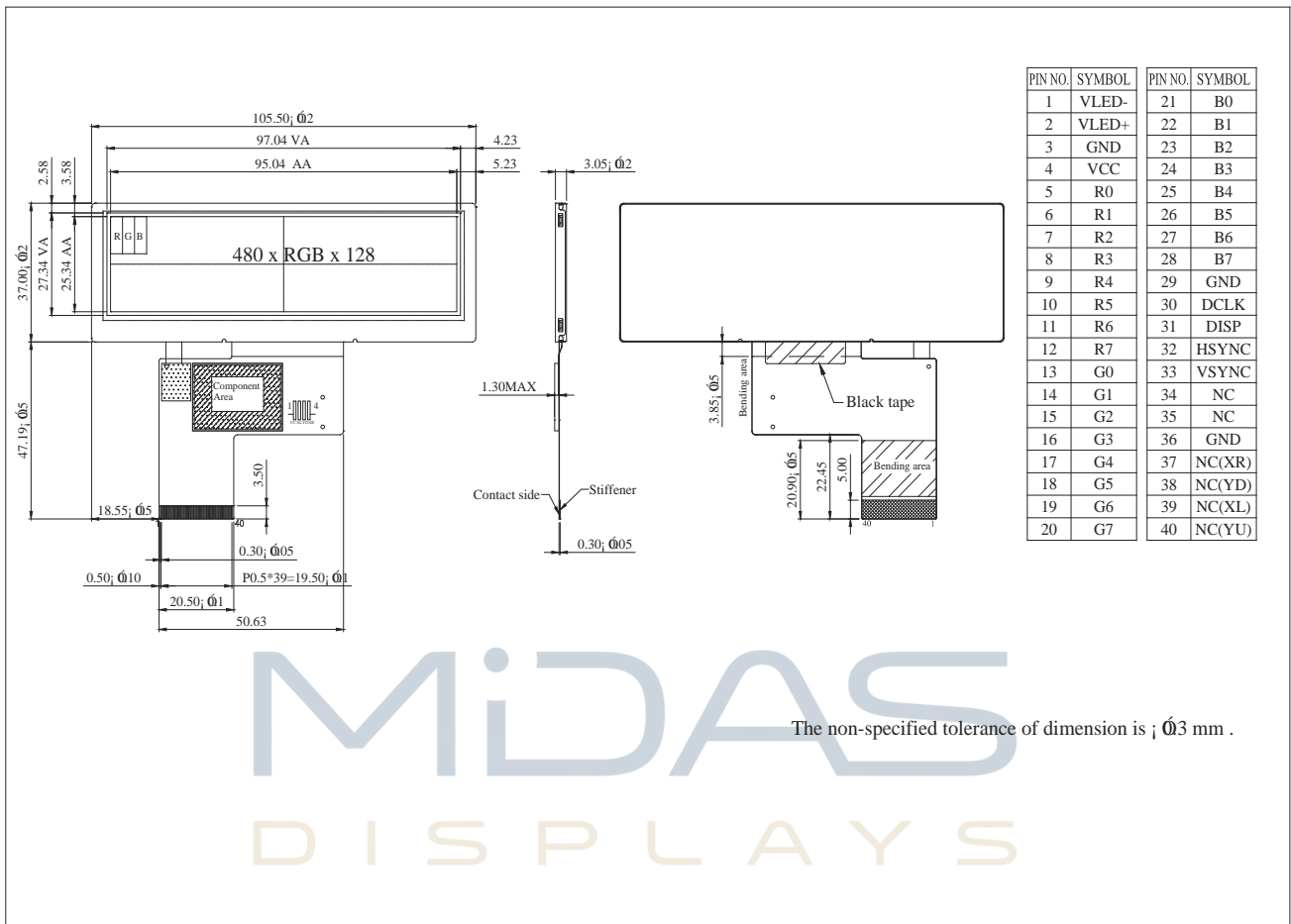

The non-specified tolerance of dimension is ; $\varnothing 3$ mm .

MIDAS
DISPLAYS

DESIGN • MANUFACTURE • SUPPLY



Block Diagram

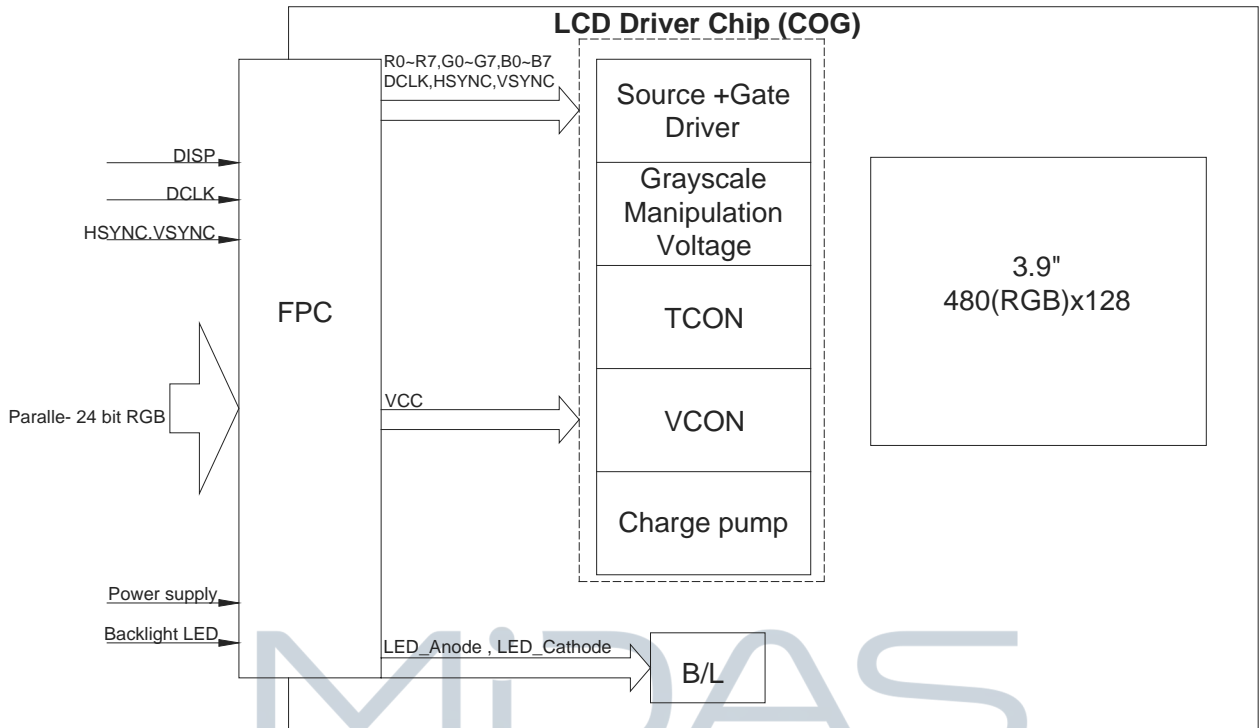

MIDAS
DISPLAYS

DESIGN • MANUFACTURE • SUPPLY



Absolute Maximum Ratings

Item	Symbol	Min	Typ	Max	Unit
Operating Temperature	TOP	-30	—	+85	°C
Storage Temperature	TST	-30	—	+85	°C

Note: Device is subject to be damaged permanently if stresses beyond those absolute maximum ratings listed above

- Temp. $\leq 60^{\circ}\text{C}$, 90% RH MAX. Temp. $> 60^{\circ}\text{C}$, Absolute humidity shall be less than 90% RH at 60°C

Electrical Characteristics

1. Operating conditions:

Item	Symbol	Min	Typ	Max	Unit	Remark
Supply Voltage For LCM	VCC	3.0	-	3.6	V	
Supply Current For LCM	ICC	-	20	30	mA	Note1

Note 1 : This value is test for VCC=3.3V , Ta=25 °C only

2. LED driving conditions

Parameter	Symbol	Min.	Typ.	Max.	Unit	Remark
LED current	-	-	40	-	mA	-
Power Consumption	-	560	600	680	mW	-
LED voltage	VLED+	14	15	17	V	Note 1
LED Life Time	-	-	50,000	-	Hr	Note 2,3,4

Note 1 : There are 1 Groups LED

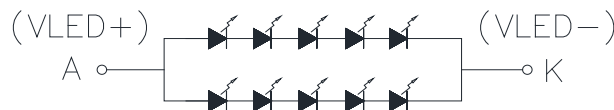

CIRCUIT DIAGRAM

Note 2 : Ta = 25 °C

Note 3 : Brightness to be decreased to 50% of the initial value

Note 4 : The single LED lamp case

AC Characteristics

AC Electrical Characteristics (VCC= 3.3V, GND= 0V, TA=25°C)

1. RGB Interface SYNC Mode

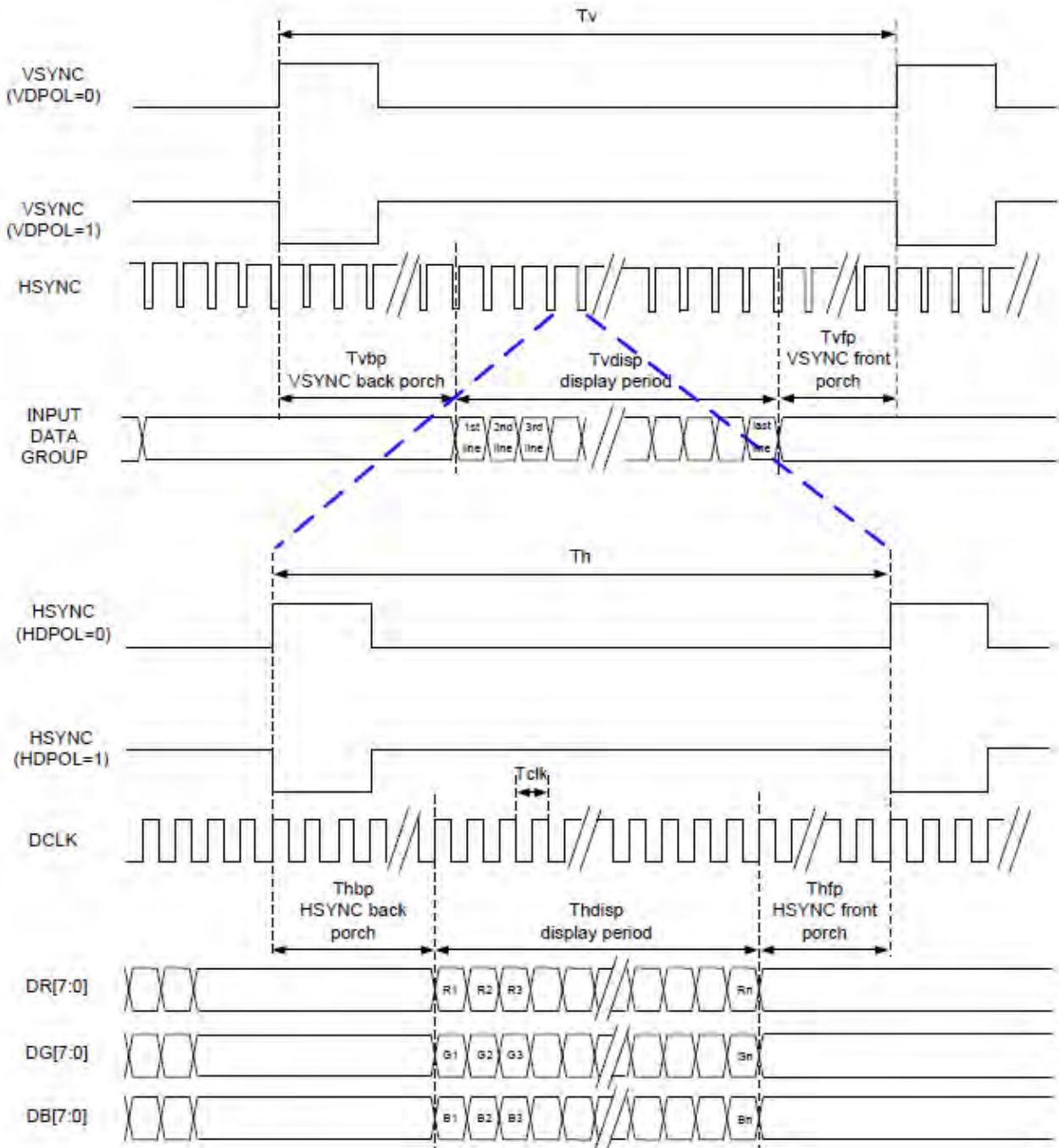

2. Parallel 24 bit RGB Input Timing Table

(Parallel 24-bit RGB Input Timing (VCC= 3.3V, GND= 0V, TA=25°C))

480RGB X 272 Resolution Timing Table							
Item	Symbol	Min.	Typ.	Max.	Unit	Remark	
DCLK Frequency	Fclk	8	9	12	MHz		
DCLK Period	Tclk	83	111	125	ns		
HSYNC	Period Time	Th	485	531	598	DCLK	
	Display Period	Thdisp		480		DCLK	
	Back Porch	Thbp	3	43	43	DCLK	Thbp of SYNC mode set by H_BLANKING[7:0]
	Front Porch	Thfp	2	8	75	DCLK	
	Pulse Width	Thw	2	4	43	DCLK	
VSYNC	Period Time	Tv	276	292	321	HSYNC	
	Display Period	Tvdisp		272		HSYNC	
	Back Porch	Tvbp	2	12	12	HSYNC	Tvbp of SYNC mode set by V_BLANKING[7:0]
	Front Porch	Tvfp	2	8	37	HSYNC	
	Pulse Width	Tvw	2	4	12	HSYNC	

Note: It is necessary to keep Tvbp =12 and Thbp =43 in sync mode. DE mode is unnecessary to keep it.

DESIGN • MANUFACTURE • SUPPLY



3. System Bus Timing for RGB Interface

(VCC= 3.3V, GND= 0V, TA=25°C)

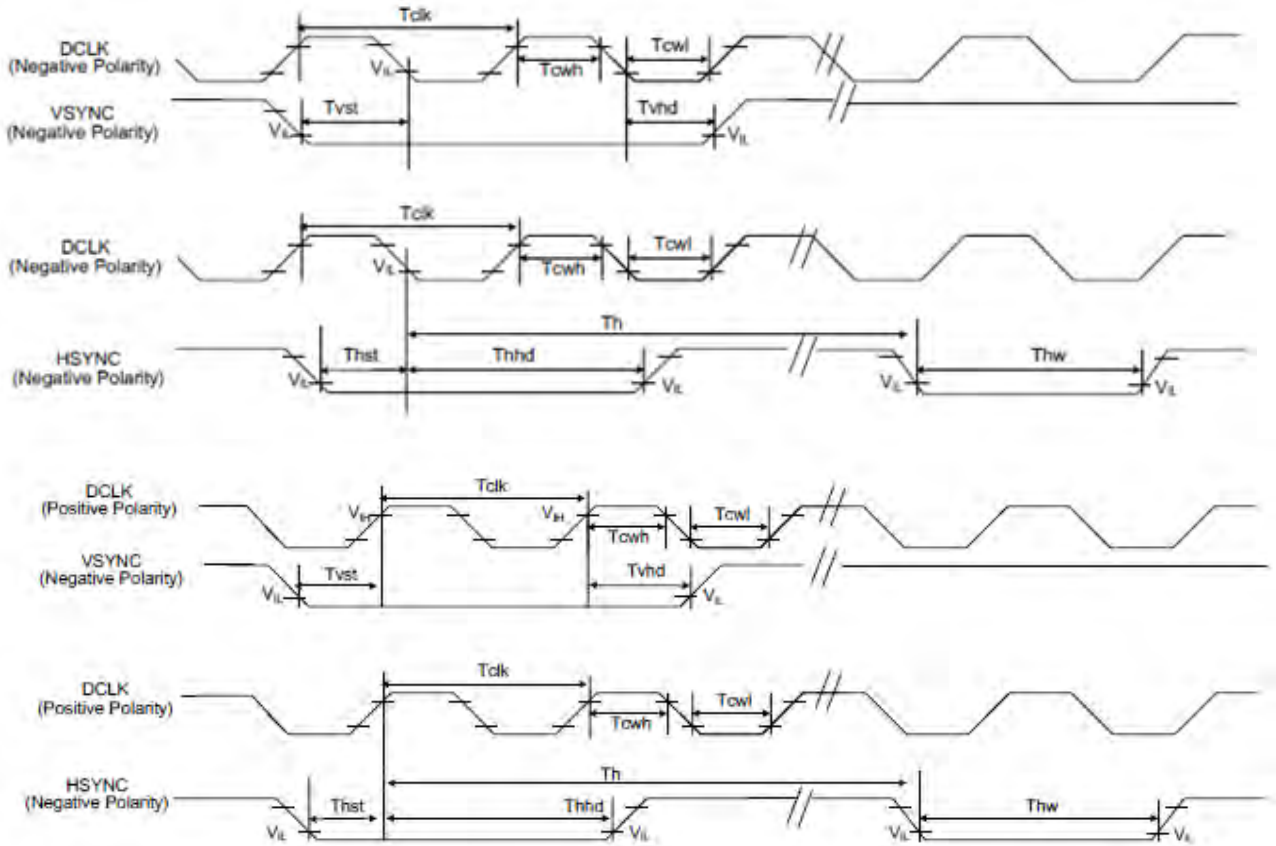

Item	Symbol	Min.	Typ.	Max.	Unit	Conditions
CLK Pulse Duty	Tcw	40	50	60	%	
HSYNC Width	Thw	2	-	-	DCLK	
VSYNC Setup Time	Tvst	12	-	-	ns	
VSYNC Hold Time	Tvhd	12	-	-	ns	
HSYNC Setup Time	Thst	12	-	-	ns	
HSYNC Hold Time	Thhd	12	-	-	ns	
Data Setup Time	Tdsu	12	-	-	ns	
Data Hold Time	Tdhd	12	-	-	ns	



Power sequence

1. Power On Sequence

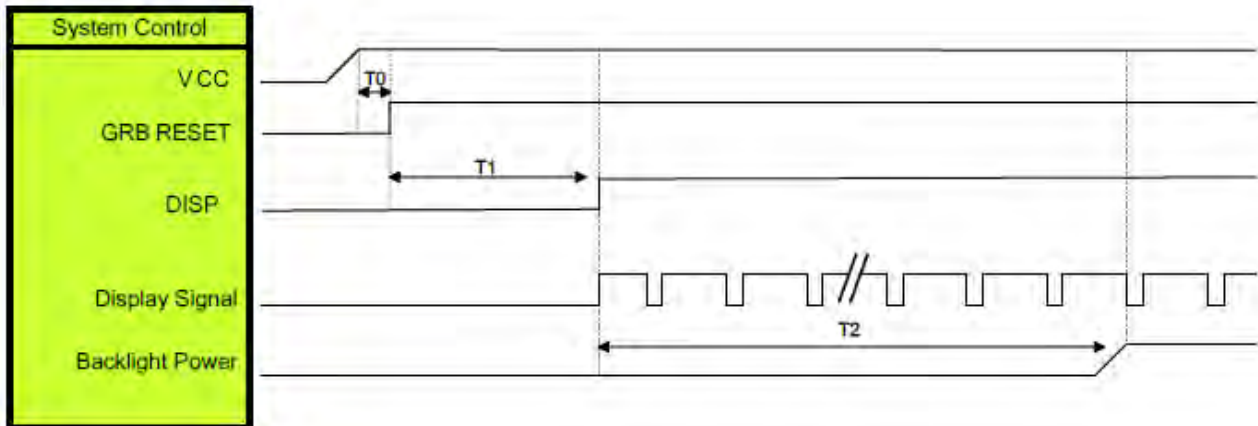

Symbol	Description	Min. Time	Unit
T0	System power stability to GRB RESET signal	0	ms
T1	GRB RESET= "High" to DISP="High"	10	ms
T2	Display Signal output to Backlight Power on	250	ms

2. Power Off Sequence

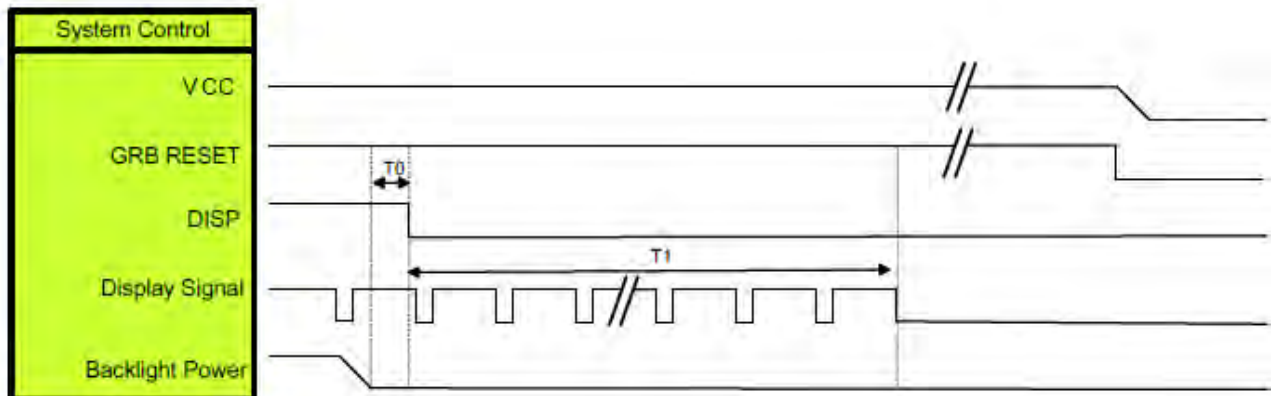

Symbol	Description	Min. Time	Unit
T0	Backlight Power off to DISP="Low"	5	ms
T1	DISP="Low" to IC internal voltage discharge complete	80	ms

Optical Characteristics

Item	Symbol	Condition.	Min	Typ.	Max.	Unit	Remark	
Response time	Tr+ Tf	$\theta=0^\circ$ 、 $\Phi=0^\circ$	-	30	40	ms	Note 3	
Contrast ratio	CR	At optimized viewing angle	640	800	-	-	Note 4	
Color Chromaticity	White	Wx	$\theta=0^\circ$ 、 $\Phi=0$	0.27	0.32	0.37	-	Note 2,6,7
		Wy		0.295	0.345	0.395	-	
Viewing angle	Hor.	Θ_R	$CR \geq 10$	70	80	-	Deg.	Note 1
		Θ_L		70	80	-		
	Ver.	Φ_T		70	80	-		
		Φ_B		70	80	-		
Brightness	-	-	400	500	-	cd/m ²	Center of display	
Uniformity	(U)	-	75	-	-	%	Note 5	

Ta=25±2°C

Note 1: Definition of viewing angle range

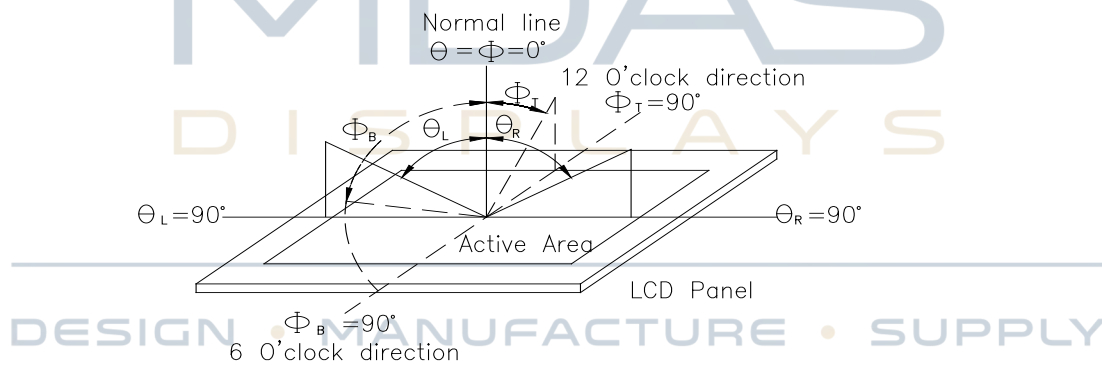

Fig. 11.1. Definition of viewing angle

Note 2: Test equipment setup:

After stabilizing and leaving the panel alone at a driven temperature for 10 minutes, the measurement should be executed. Measurement should be executed in a stable, windless, and dark room. Optical specifications are measured by Topcon BM-7orBM-5 luminance meter 1.0° field of view at a distance of 50cm and normal direction.



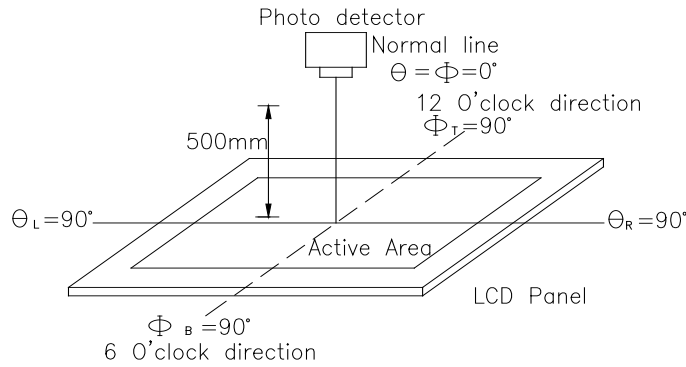
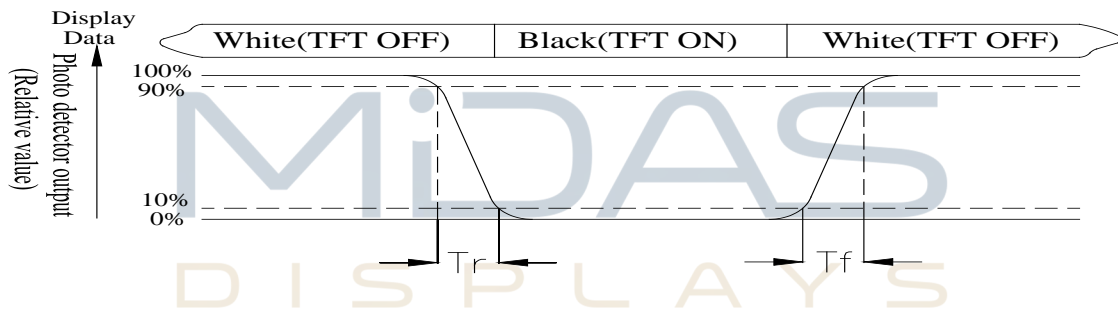

Fig. 11.2. Optical measurement system setup

Note 3: Definition of Response time:

The response time is defined as the LCD optical switching time interval between "White" state and "Black" state. Rise time, T_r , is the time between photo detector output intensity changed from 90% to 10%. And fall time, T_f , is the time between photo detector output intensity changed from 10% to 90%



Note 4: Definition of contrast ratio:

The contrast ratio is defined as the following expression.

$$\text{Contrast ratio (CR)} = \frac{\text{Luminance measured when LCD on the "White" state}}{\text{Luminance measured when LCD on the "Black" state}}$$



Note 5: Definition of Luminance Uniformity

Active area is divided into 9 measuring areas (reference the picture in below). Every measuring point is placed at the center of each measuring area.

Luminance Uniformity (U) = $L_{min}/L_{max} \times 100\%$

L = Active area length

W = Active area width

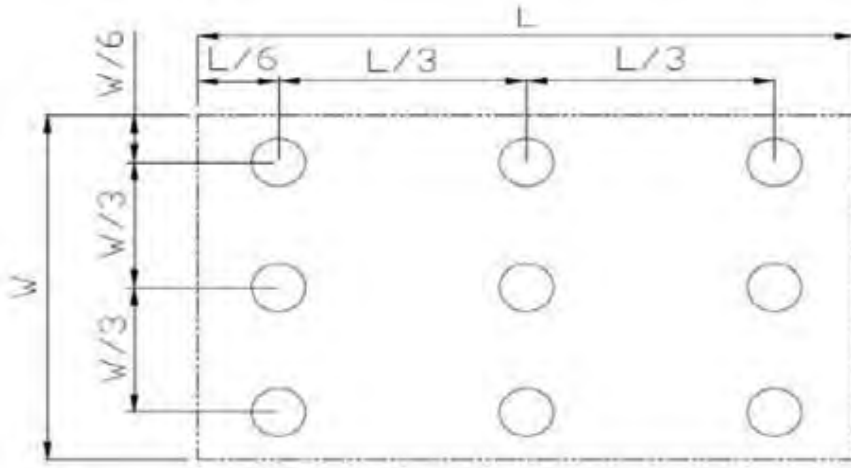

Fig 11.3. Definition of uniformity

Note 6: Definition of color chromaticity (CIE 1931)

Color coordinates measured at the center point of LCD

Note 7: Measured at the center area of the panel when all the input terminals of LCD panel are electrically opened.

DESIGN • MANUFACTURE • SUPPLY



Reliability

Content of Reliability Test (Super Wide temperature, -30°C~85°C)

Environmental Test			
Test Item	Content of Test	Test Condition	Note
High Temperature storage	Endurance test applying the high storage temperature for a long time.	85°C 200hrs	2
Low Temperature storage	Endurance test applying the low storage temperature for a long time.	-30°C 200hrs	1,2
High Temperature Operation	Endurance test applying the electric stress (Voltage & Current) and the thermal stress to the element for a long time.	85°C 200hrs	—
Low Temperature Operation	Endurance test applying the electric stress under low temperature for a long time.	-30°C 200hrs	1
High Temperature/ Humidity storage	The module should be allowed to stand at 60°C,90%RH max	60°C,90%RH 96hrs	1,2
Thermal shock resistance	The sample should be allowed stand the following 10 cycles of operation <div style="text-align: center;"> <p style="margin: 0;">-30°C 25°C 85°C</p> <p style="margin: 0;">30min 5min 30min</p> <p style="margin: 0;">1 cycle</p> </div>	-30°C/85°C 10 cycles	—
Vibration test	Endurance test applying the vibration during transportation and using.	Total fixed amplitude : 1.5mm Vibration Frequency : 10~55Hz One cycle 60 seconds to 3 directions of X,Y,Z for Each 15 minutes	3
Static electricity test	Endurance test applying the electric stress to the terminal.	VS=±600V(contact) ,±800v(air), RS=330Ω CS=150pF 10 times	—

Note1: No dew condensation to be observed.

Note2: The function test shall be conducted after 4 hours storage at the normal Temperature and humidity after remove from the test chamber.

Note3: The packing have to including into the vibration testing.

Display start address setting

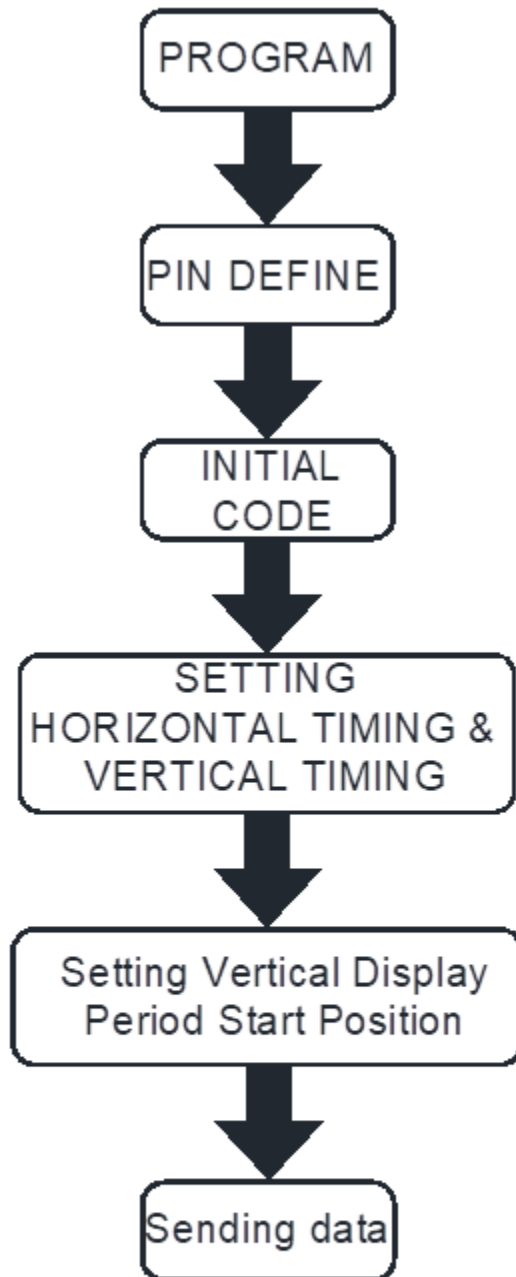

Ex.

One horizontal line=0x0213

VS period time=0x0124

HS Blanking=0x2b

VS Blanking=0x10

HS Front Porch=0x05

VS Front Porch=0x08

Suggestion :

Vertical Display Period

Start Position= 0x9D

Note :

For different Controller ICs, the value of vertical display period start position need to be adjusted accordingly.

