

# OSRAM SFH 3310

## Datasheet

Published by **ams-OSRAM AG**

Tobelbader Strasse 30, 8141 Premstaetten, Austria

Phone +43 3136 500-0

[ams-osram.com](http://ams-osram.com)

© All rights reserved



## Radial T1 Ambient Light Sensor

# SFH 3310

Silicon NPN Phototransistor with  $V_{\lambda}$  Characteristics



### Applications

- Access Control & Security
- Appliances & Tools

### Features

- Package: clear epoxy
- ESD: 2 kV acc. to ANSI/ESDA/JEDEC JS-001 (HBM, Class 2)
- Adapted to human eye sensitivity ( $V_{\lambda}$ )
- Spectral range of sensitivity: (typ) 400 ... 950 nm

## Ordering Information

Type	Photocurrent <sup>1)</sup>  $V_{CE} = 5 \text{ V}; \lambda = 560 \text{ nm}; E_e = 0.01 \text{ mW/cm}^2$ $I_{PCE}$	Photocurrent <sup>2)</sup> typ. $V_{CE} = 5 \text{ V}; \lambda = 560 \text{ nm}; E_e = 0.01 \text{ mW/cm}^2$ $I_{PCE}$	Ordering Code
SFH 3310	2.8 ... 7.1 $\mu\text{A}$	4.8 $\mu\text{A}$	Q65110A5343

## Maximum Ratings

 $T_A = 25\text{ °C}$ 

Parameter	Symbol		Values
Operating temperature	$T_{op}$	min.	-40 °C
		max.	100 °C
Storage temperature	$T_{stg}$	min.	-40 °C
		max.	100 °C
Collector-emitter voltage	$V_{CE}$	max.	5.5 V
Collector current	$I_C$	max.	20 mA
Emitter-collector voltage	$V_{EC}$	max.	0.5 V
ESD withstand voltage acc. to ANSI/ESDA/JEDEC JS-001 (HBM, Class 2)	$V_{ESD}$	max.	2 kV

## Characteristics

 $T_A = 25\text{ °C}$ 

Parameter	Symbol		Values
Wavelength of max sensitivity	$\lambda_{S\ max}$	typ.	615 nm
Spectral range of sensitivity	$\lambda_{10\%}$	typ.	395 ... 960 nm
Dimensions of chip area	L x W	typ.	0.75 x 0.75 mm x mm
Radiant sensitive area	A	typ.	0.29 mm <sup>2</sup>
Half angle	$\varphi$	typ.	80 °
Photocurrent $E_v = 1000\text{ lx}$ ; Std. Light A ; $V_{CE} = 5\text{ V}$	$I_{PCE}$	typ.	450 $\mu\text{A}$
Dark current $V_{CE} = 5\text{ V}$ ; $E = 0$	$I_{CE0}$	typ. max.	3 nA 50 nA
Collector-emitter saturation voltage <sup>3)</sup> $I_C = I_{PCE, \min} \times 0.3$ ; $\lambda = 560\text{ nm}$ ; $E_e = 0.01\text{ mW/cm}^2$	$V_{CEsat}$	typ.	150 mV
Capacitance $V_{CE} = 0\text{ V}$ ; $f = 1\text{ MHz}$ ; $E = 0$	$C_{CE}$	typ.	4.2 pF

## Photocurrent Groups

$T_A = 25\text{ °C}$

Group	Photocurrent <sup>1)</sup>	Photocurrent <sup>1)</sup>
	$V_{CE} = 5\text{ V}; \lambda = 560\text{ nm}; E_e = 0.01\text{ mW/cm}^2$ min. $I_{PCE}$	$V_{CE} = 5\text{ V}; \lambda = 560\text{ nm}; E_e = 0.01\text{ mW/cm}^2$ max. $I_{PCE}$
2	2.8 $\mu\text{A}$	4.5 $\mu\text{A}$
3	4.5 $\mu\text{A}$	7.1 $\mu\text{A}$

### Relative Spectral Sensitivity 4), 5)

$$S_{rel} = f(\lambda)$$

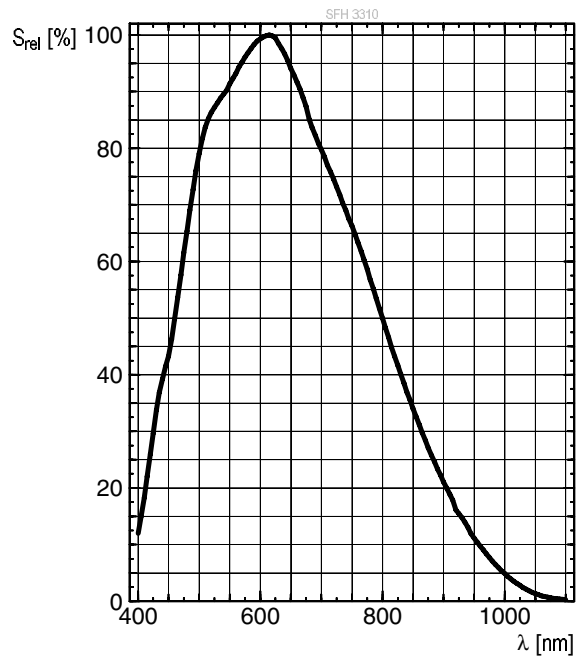

### Directional Characteristics 4), 5)

$$S_{rel} = f(\varphi)$$

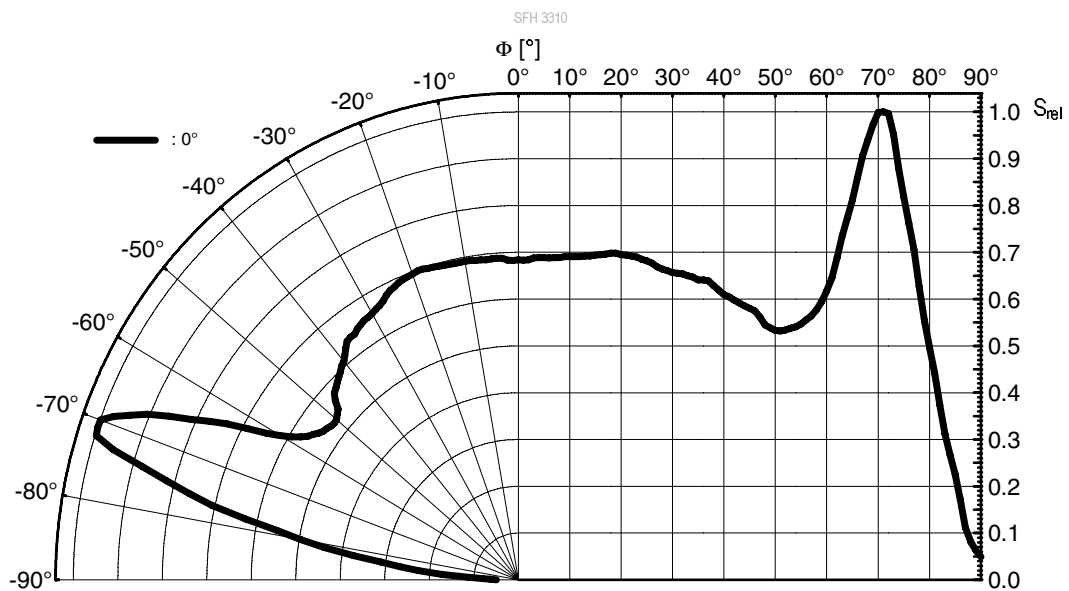

**Photocurrent** 4), 5)

$I_{PCE} = f(E_V); V_{CE} = 5\text{ V}$

$I_{CE}$  [ $\mu\text{A}$ ]

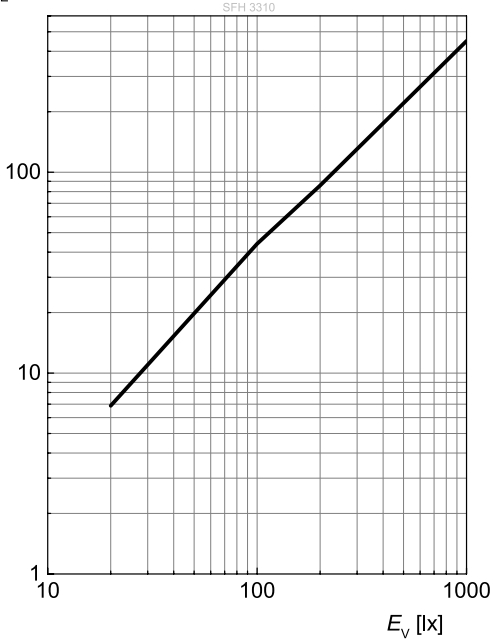

**Photocurrent** 4), 5)

$I_{CE} = f(V_{CE}); E_V = \text{Parameter}$

$I_{CE}$  [ $\mu\text{A}$ ]

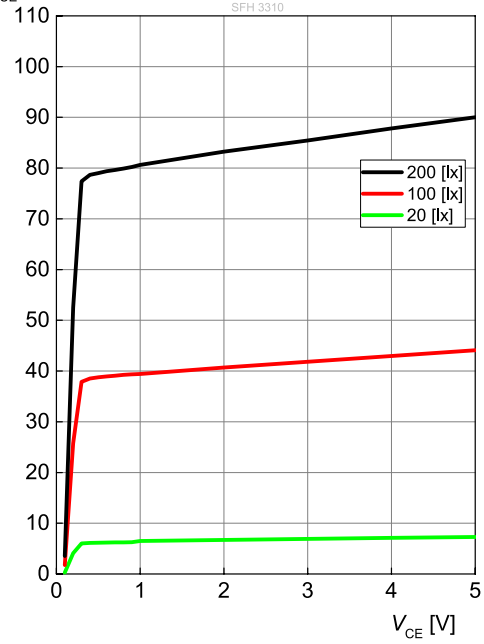

**Collector-Emitter Capacitance** 4), 5)

$C_{CE} = f(V_{CE}); f = 1\text{ MHz}; E = 0$

$C_{CE}$  [pF]

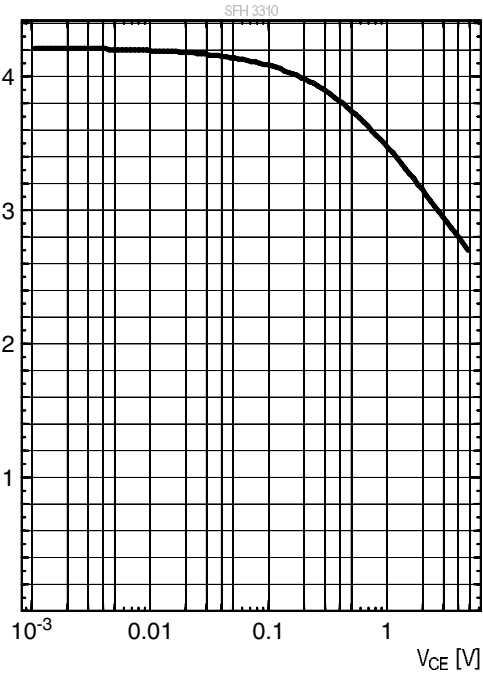



## Photocurrent 4)

$I_{PCE,rel} = f(T_A)$ ;  $V_{CE} = 5\text{ V}$ ;  $E_v = 100\text{ lx}$ ; Std. Light A

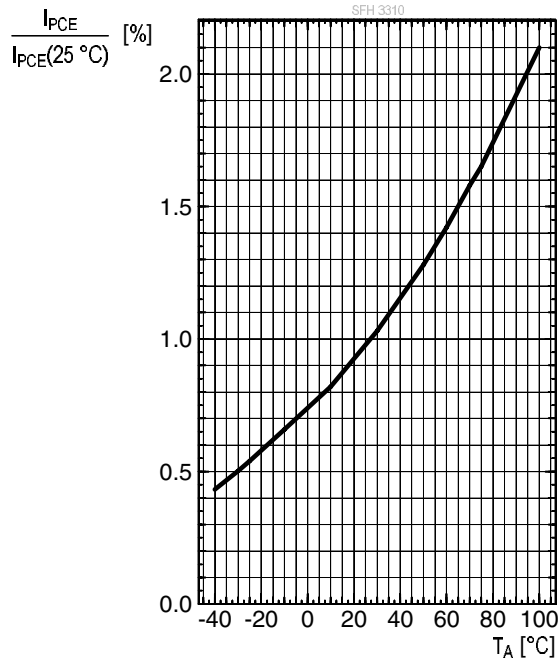

Dimensional Drawing <sup>6)</sup>

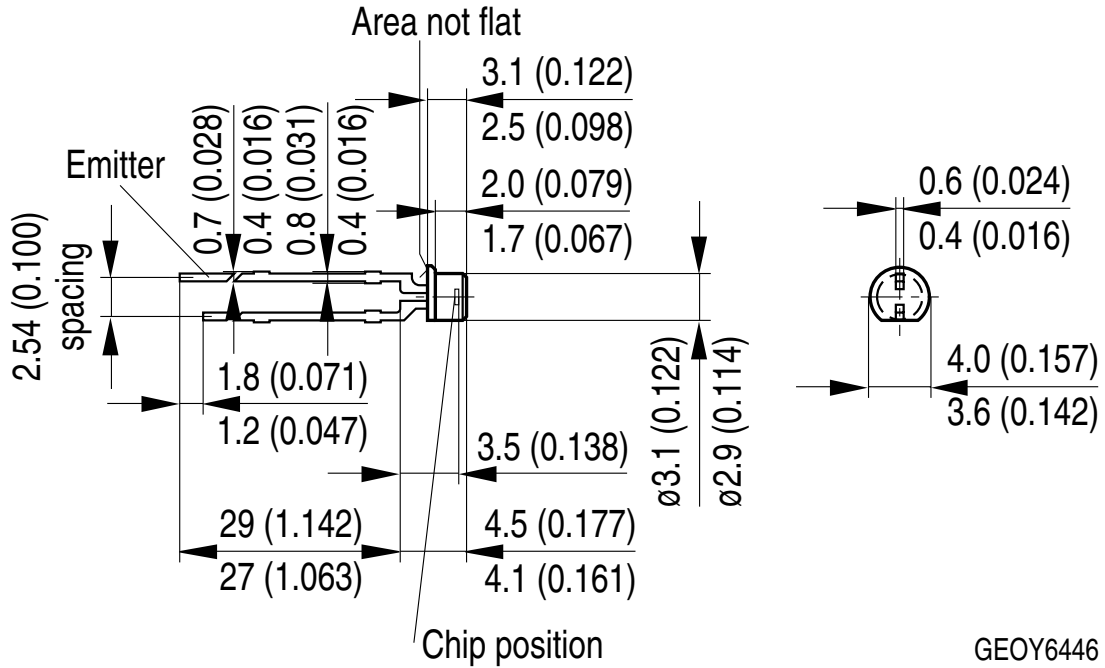

GEOY6446

Further Information:

Approximate Weight: 156.0 mg

Package marking: Collector

Recommended Solder Pad <sup>6)</sup>

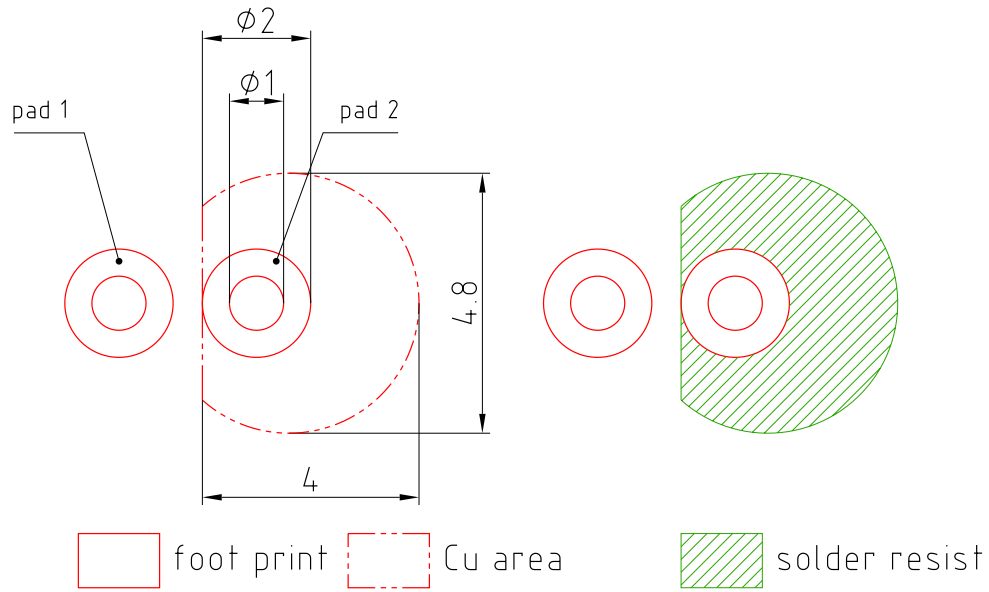

E062.3010.188-01

Pad 1: emitter

## TTW Soldering

IEC-61760-1 TTW

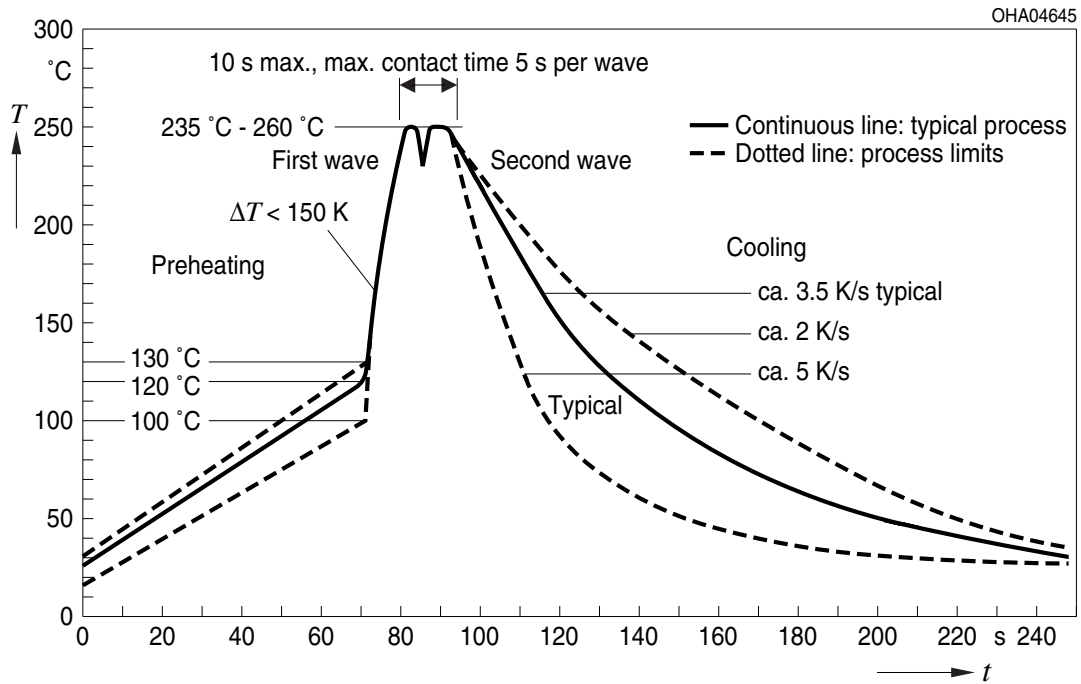

### Notes

Subcomponents of this device contain, in addition to other substances, metal filled materials including silver. Metal filled materials can be affected by environments that contain traces of aggressive substances. Therefore, we recommend that customers minimize device exposure to aggressive substances during storage, production, and use. Devices that showed visible discoloration when tested using the described tests above did show no performance deviations within failure limits during the stated test duration. Respective failure limits are described in the IEC60810.

Packing information is available on the internet (online product catalog).

For further application related information please visit <https://ams-osram.com/support/application-notes>

## Disclaimer

### Attention please!

The information describes the type of component and shall not be considered as assured characteristics. Terms of delivery and rights to change design reserved. Due to technical requirements components may contain dangerous substances.

For information on the types in question please contact our Sales Organization.

If printed or downloaded, please find the latest version on our website.

### Packing

Please use the recycling operators known to you. We can also help you – get in touch with your nearest sales office. By agreement we will take packing material back, if it is sorted. You must bear the costs of transport. For packing material that is returned to us unsorted or which we are not obliged to accept, we shall have to invoice you for any costs incurred.

### Product and functional safety devices/applications or medical devices/applications

Our components are not developed, constructed or tested for the application as safety relevant component or for the application in medical devices.

Our products are not qualified at module and system level for such application.

In case buyer – or customer supplied by buyer – considers using our components in product safety devices/ applications or medical devices/applications, buyer and/or customer has to inform our local sales partner immediately and we and buyer and /or customer will analyze and coordinate the customer-specific request between us and buyer and/or customer.

---

## Glossary

- 1) **Photocurrent:** The photocurrent values are measured (by irradiating the devices with a homogenous light source and applying a voltage to the device) with a tolerance of  $\pm 11\%$ .
- 2) **Tolerance of Measure:** Unless otherwise noted in drawing, tolerances are specified with  $\pm 0.1$  and dimensions are specified in mm.
- 3) **IPCEmin:** IPCEmin is the min. photocurrent of the specified group.
- 4) **Typical Values:** Due to the special conditions of the manufacturing processes of semiconductor devices, the typical data or calculated correlations of technical parameters can only reflect statistical figures. These do not necessarily correspond to the actual parameters of each single product, which could differ from the typical data and calculated correlations or the typical characteristic line. If requested, e.g. because of technical improvements, these typ. data will be changed without any further notice.
- 5) **Testing temperature:** TA = 25°C (unless otherwise specified)
- 6) **Tolerance of Measure:** Unless otherwise noted in drawing, tolerances are specified with  $\pm 0.1$  and dimensions are specified in mm.

---

## Revision History

Version	Date	Change
1.4	2023-06-16	New Layout Applications Characteristics Electro - Optical Characteristics (Diagrams)

---



EU RoHS and China RoHS compliant product

此产品符合欧盟 RoHS 指令的要求；  
按照中国的相关法规和标准，  
不含有毒有害物质或元素。

**Published by ams-OSRAM AG**

Tobelbader Strasse 30, 8141 Premstaetten, Austria

Phone +43 3136 500-0

[ams-osram.com](http://ams-osram.com)

© All rights reserved

**am** 

**OSRAM**