

Product Document

TMD2755

ALS + Proximity Sensor Module

General Description

The TMD2755 features proximity detection and digital ambient light sensing (ALS). The extremely narrow 1.1mm module incorporates an IR VCSEL and factory calibrated VCSEL driver. The proximity detection feature provides object detection (e.g. mobile device screen to user's ear) by photodiode detection of reflected IR energy (sourced by the integrated VCSEL). Detect/release events are interrupt driven, and occur when proximity result crosses upper and/or lower threshold settings. The proximity engine features a wide range offset adjustment to compensate for unwanted IR energy reflection at the sensor. Proximity results are further improved by automatic ambient light subtraction. The ALS and IR photodiodes have dedicated data converters producing 16-bit data. This architecture allows applications to accurately measure ambient light which enables devices to calculate illuminance to control display backlight.

Ordering Information and Content Guide appear at end of datasheet.

Key Benefits & Features

The benefits and features of TMD2755, ALS + Proximity Sensor Module are listed below:

Figure 1:
Added Value of Using TMD2755

Benefits	Features
<ul style="list-style-type: none"> Optimized for narrow bezel mobile phones 	<ul style="list-style-type: none"> Small narrow 1.1mm x 3.25mm x 0.60mm module
<ul style="list-style-type: none"> Reduced power consumption 	<ul style="list-style-type: none"> 1.8V power supply with 1.8V I²C bus Sleep mode (0.7µA) VCSEL IR emitter
<ul style="list-style-type: none"> Enabled superior proximity detection 	<ul style="list-style-type: none"> Integrated factory calibrated 940nm IR VCSEL Crosstalk and ambient light cancellation Wide configuration range
<ul style="list-style-type: none"> Accurate ambient light sensing 	<ul style="list-style-type: none"> High sensitivity 2 channels (photopic ALS + IR) Programmable gain and integration time
<ul style="list-style-type: none"> Industrial design flexibility 	<ul style="list-style-type: none"> Offset emitter/detector package design

Applications

The TMD2755 applications include:

- Mobile phone display management
- Mobile phone user proximity detection

Block Diagram

The functional blocks of this device are shown below:

Figure 2:
Functional Blocks of TMD2755

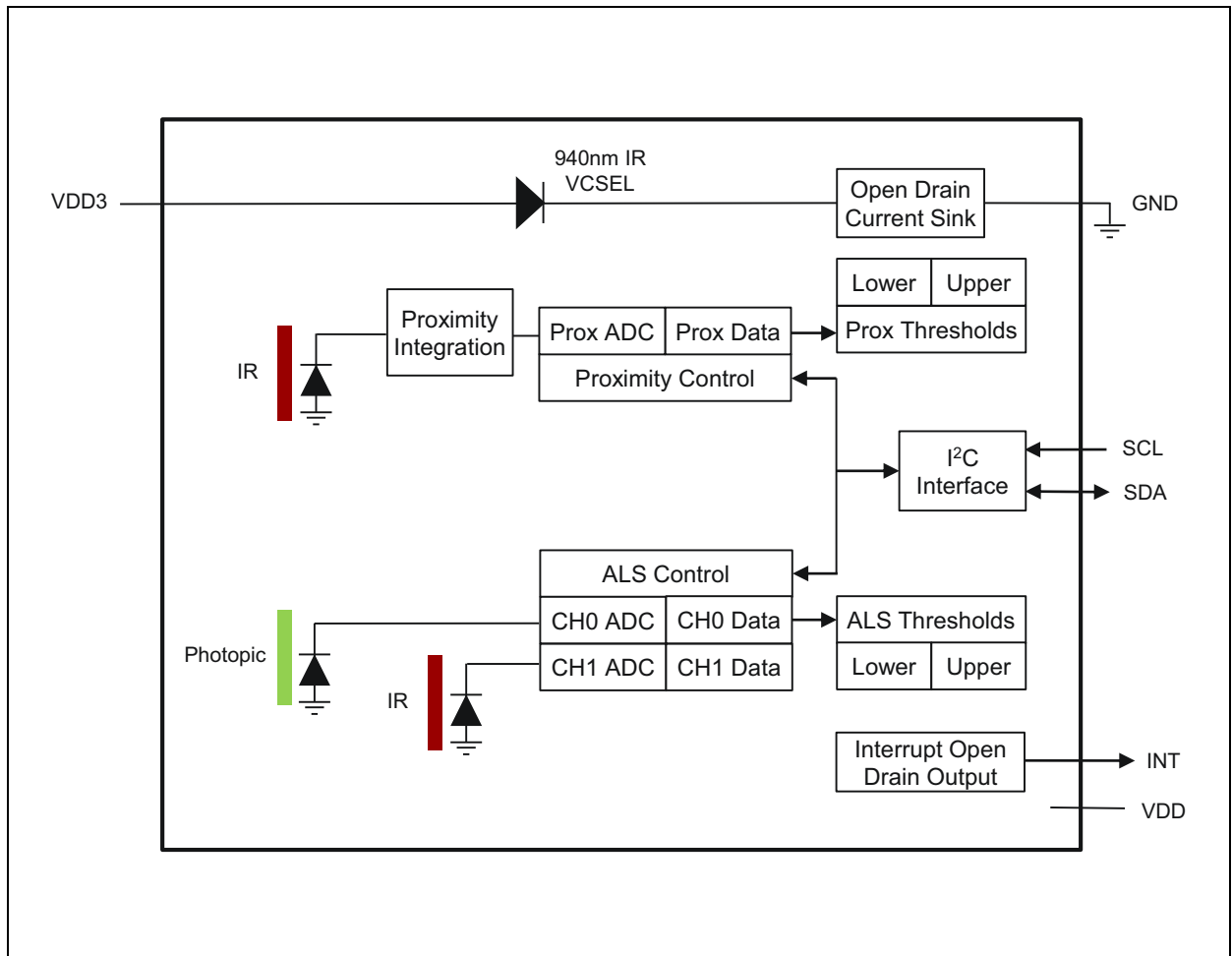

Pin Assignments

Figure 3:
Pin Diagram

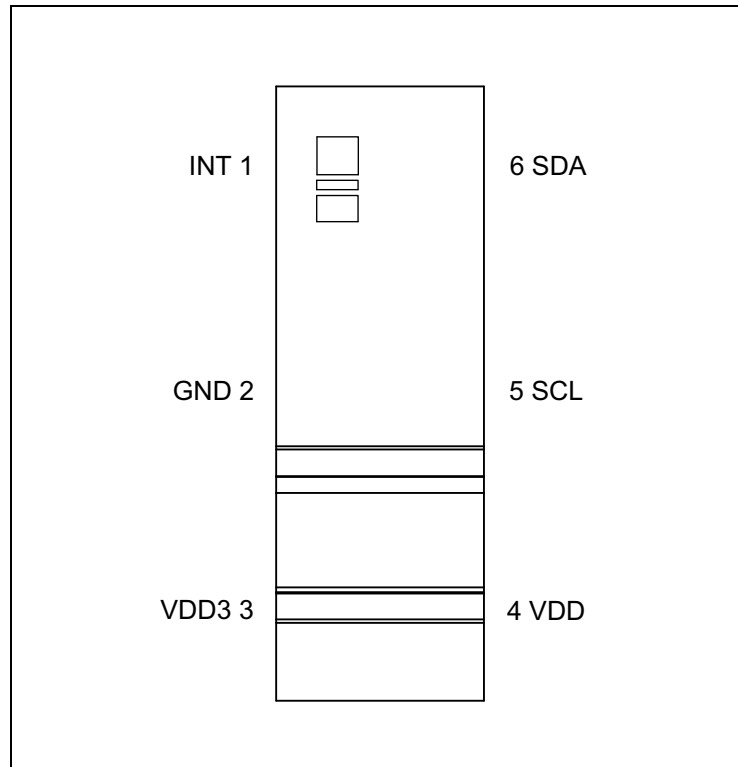

Figure 4:
Pin Description of TMD2755

Pin Number	Pin Name	Description
1	INT	Interrupt. Open drain output (active low). If INT is not used, tie to GND for enhanced ESD protection.
2	GND	Ground. All voltages are referenced to GND.
3	VDD3	Supply voltage for IR emitter (3.0/3.3V)
4	VDD	Supply voltage for sensor (1.8V). To enable the device to recover from a high voltage ESD strike, it is recommended to connect VDD to a host GPIO pin for independent power control.
5	SCL	I ² C serial clock input terminal
6	SDA	I ² C serial data I/O terminal

Absolute Maximum Ratings

Stresses beyond those listed under [Absolute Maximum Ratings](#) may cause permanent damage to the device. These are stress ratings only. Functional operation of the device at these or any other conditions beyond those indicated under [Electrical Characteristics](#) is not implied. Exposure to absolute maximum rating conditions for extended periods may affect device reliability.

Figure 5:
Absolute Maximum Ratings

Symbol	Parameter	Min	Max	Units	Comments
Electrical Parameters					
VDD	Supply Voltage to GND	-0.3	1.98	V	
VDD3	IR Emitter Voltage to GND	-0.3	3.6	V	
V _{IO}	Digital I/O Terminal Voltage	-0.3	3.6	V	
I _{IO}	Digital Output Terminal Current	-1	20	mA	
Electrostatic Discharge					
I _{SCR}	Input Current (latch-up immunity)	± 100		mA	Class II JEDEC JESD78E
ESD _{HBM}	HBM Electrostatic Discharge	± 2000		V	JEDEC/ESDA JS-001-2017
ESD _{CDM}	CDM Electrostatic Discharge	± 500		V	JEDEC JS-002-2014
Temperature Ranges and Storage Conditions					
T _{STRG}	Storage Temperature Range	-40	85	°C	
T _{BODY}	Package Body Temperature		260	°C	IPC/JEDEC J-STD-020 The reflow peak soldering temperature (body temperature) is specified according to IPC/JEDEC J-STD-020 "Moisture/Reflow Sensitivity Classification for Non-hermetic Solid State Surface Mount Devices."
RH _{NC}	Relative Humidity (non-condensing)		85	%	
P _{DISS}	Power Dissipation		50	mW	Average power dissipation over a 1 second period
MSL	Moisture Sensitivity Level	3			Represents a max. floor life time of 168h

Electrical Characteristics

All limits are guaranteed. The parameters with min and max values are guaranteed with production tests or SQC (Statistical Quality Control) methods.

Figure 6:
Recommended Operating Conditions

Symbol	Parameter	Min	Typ	Max	Unit
VDD	Supply Voltage to Sensor	1.7	1.8	1.98	V
VDD3	Supply Voltage to IR Emitter	2.9	3.3	3.6	V
T _A	Operating Ambient Temperature	-30		85	°C

Note(s):

1. While the device is operational across the temperature range, performance will vary with temperature. Operational characteristics are at 25°C, unless otherwise noted.

Figure 7:
Operating Characteristics, VDD = 1.8V, T_A = 25°C (unless otherwise noted)

Symbol	Parameter	Conditions	Min	Typ	Max	Unit
f _{OSC}	Oscillator Frequency		7.9	8.1	8.3	MHz
I _{DD}	Supply Current ⁽¹⁾	Active Proximity State (PON=1) ⁽²⁾		360		μA
		Active ALS State (PON=1) ⁽²⁾		80		
		Idle State (PON=1) ⁽³⁾		35		
		Sleep State (PON = 0) ⁽⁴⁾		0.6		
V _{OL}	INT, SDA Output Low Voltage	6mA Sink Current			0.6	V
I _{LEAK}	Leakage Current, SDA, SCL, INT		-5		5	μA
V _{IH}	SCL, SDA Input High Voltage ⁽⁵⁾		1.26			V
V _{IL}	SCL, SDA Input Low Voltage				0.54	V
t _{Active}	Time from Power-On to Ready to Receive I ² C Commands			1.5		ms

Note(s):

1. Values are shown at the VDD pin and do not include current through the IR VCSEL emitter.
2. Active state occurs when PON = 1 and the device is actively integrating either proximity or ALS. For proximity, this time is determined by the number of pulses (PPLUSE) and the pulse length (PULSE_LEN). For ALS, this time is determined by the ALS integration time (ATIME). Both proximity and ALS active states can occur at the same time.
3. Idle state occurs when PON=1 and the device is not in the active state.
4. Sleep state occurs when PON = 0 and I²C bus is idle. If sleep state has been entered as the result of operational flow, SAI = 1, PON will remain high.
5. Digital pins: SDA, SCL, INT are tolerant to a communication voltage up to 3.4V

Figure 8:
ALS Optical Characteristics (VDD = 1.8V, T_A = 25°C unless otherwise noted)

Parameter	Conditions	Min	Typ	Max	Unit
CH0 ALS Sensitivity	Warm White LED @ 8μW/cm ² AGAIN = 128x ATIME = 100ms	-15%	2600	+15%	counts
	Warm White LED @ 8μW/cm ² AGAIN = 1024x ATIME = 100ms		21320		counts
CH1 ALS Sensitivity	940nm LED @ 21.1μW/cm ² AGAIN = 128x ATIME = 100ms	-20%	1483	+20%	counts
	940nm LED @ 21.1μW/cm ² AGAIN = 1024x ATIME = 100ms		12160		counts
ALS Integration Step Size		2.68	2.78	2.90	ms
ALS CH0 / CH1 Dark Count	0μW/cm ² AGAIN = 1024x ATIME = 50ms	0	1	2	counts
ALS 16x Gain Scaling	Relative to 128x		0.125		x
ALS 1024x Gain Scaling	Relative to 128x		8.2		x

Figure 9:
Proximity Optical Characteristics (VDD = 1.8V, VDD3 = 3.0V, T_A = 25°C unless otherwise noted)

Parameter	Conditions	Min	Typ	Max	Unit
Response: Absolute ⁽¹⁾	PGAIN1 = 4x; PGAIN2 = 2.5x PLDRIVE = 7mA PPULSE = 2 pulses PPULSE_LEN = 40μs HW Averaging = 8 BINSRCH_TARGET = 15 APC = disabled Post Calibration Target material: 18% reflective surface No glass above module Target Size: 100mm x 100mm Target Distance: 30mm		115		counts
Part to Part Variation ⁽³⁾	Same as Response: Absolute except target is 51mm diameter diffusor			±25	%
Response: No target ⁽²⁾	Same as Response: Absolute except no target	5	13	20	counts

Note(s):

1. Representative result by characterization.
2. Response with no target varies with power supply characteristics and system noise.
3. At factory final test.

Typical Operating Characteristics

Figure 10:
ALS Average Angular Response to 2700K White LED (pin 1 [-90°] to pin 3 [90°])

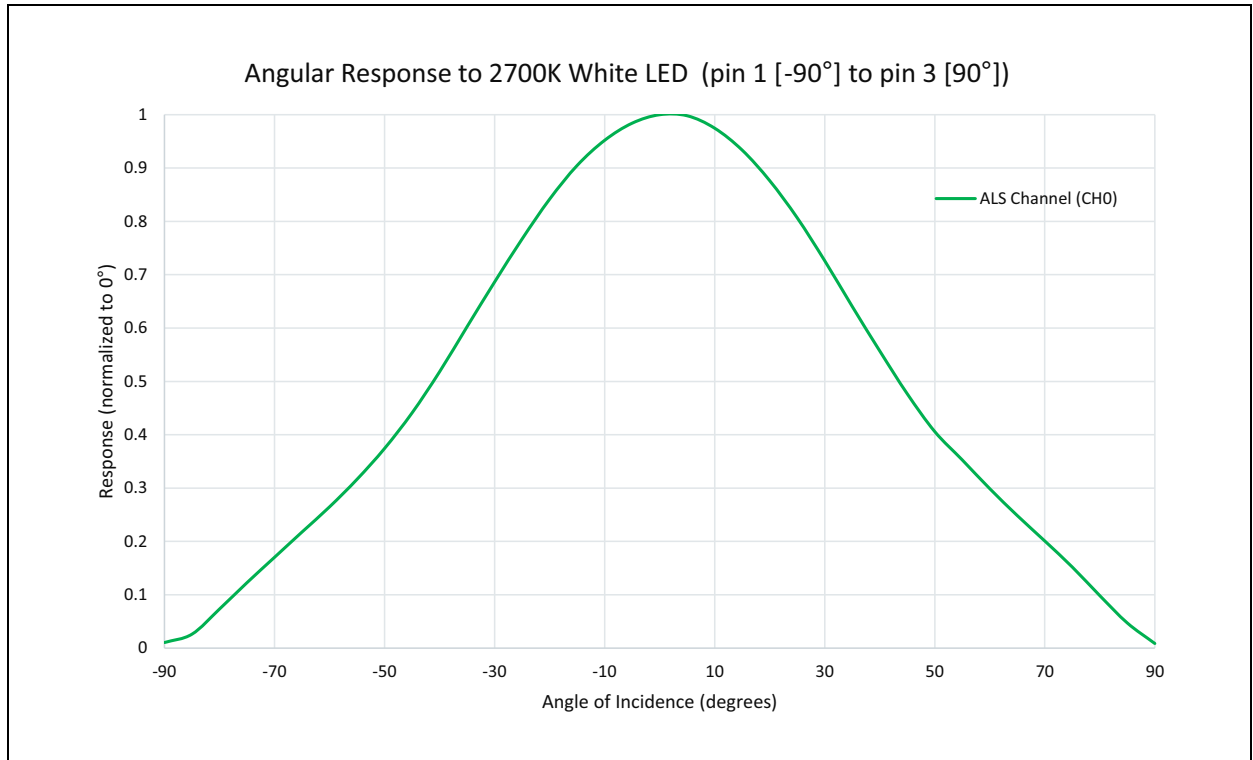

Figure 11:
ALS Average Angular Response to 2700K White LED (pin 6 [-90°] to pin 1 [90°])

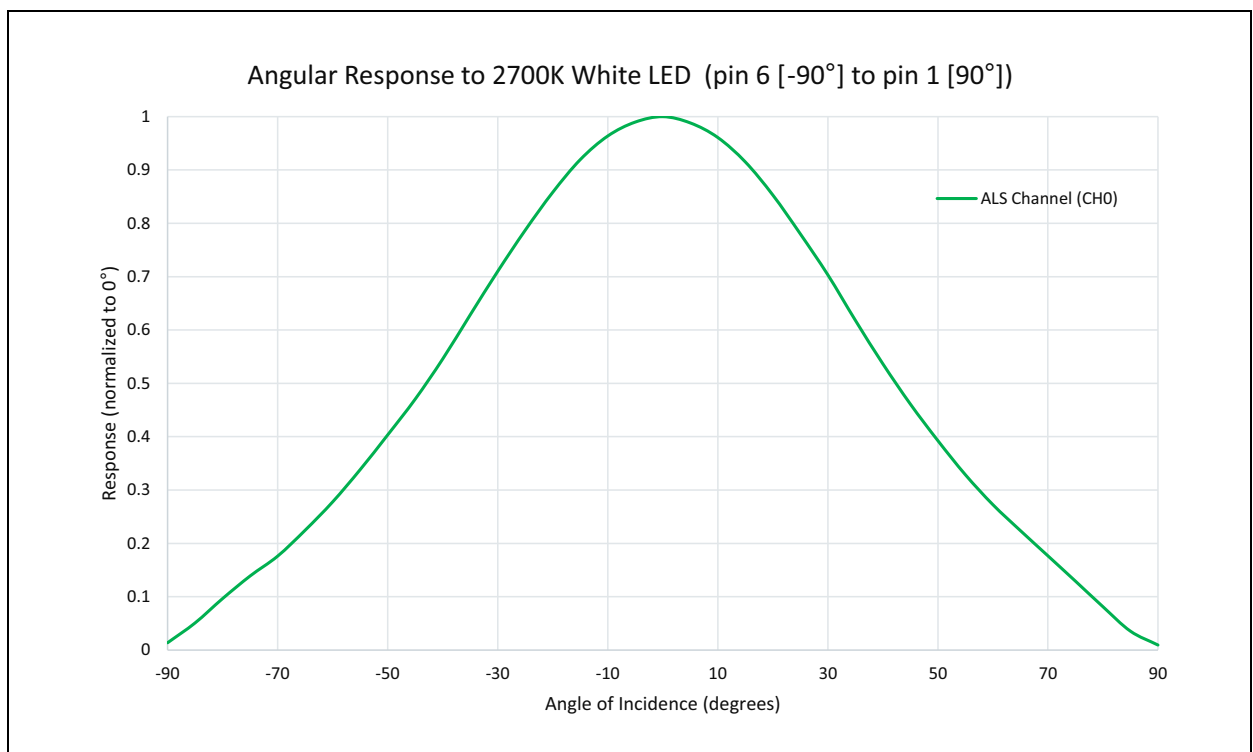

Figure 12:
Spectral Responsivity

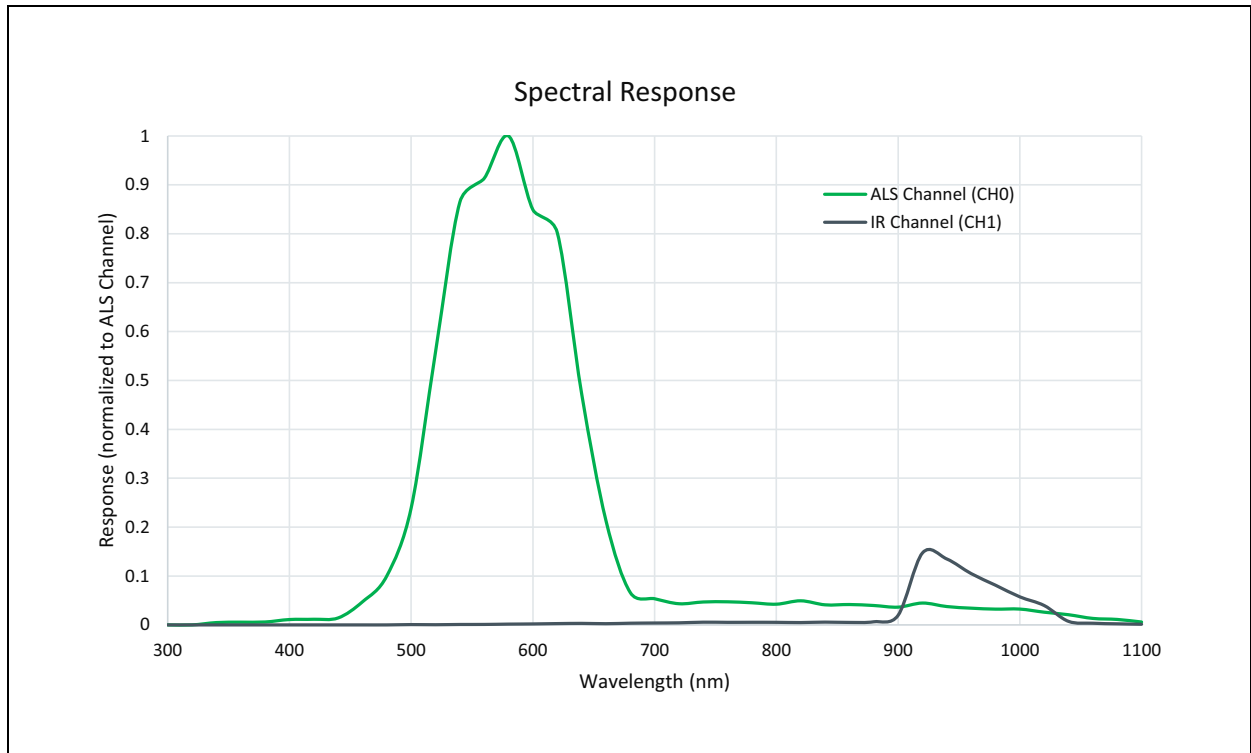
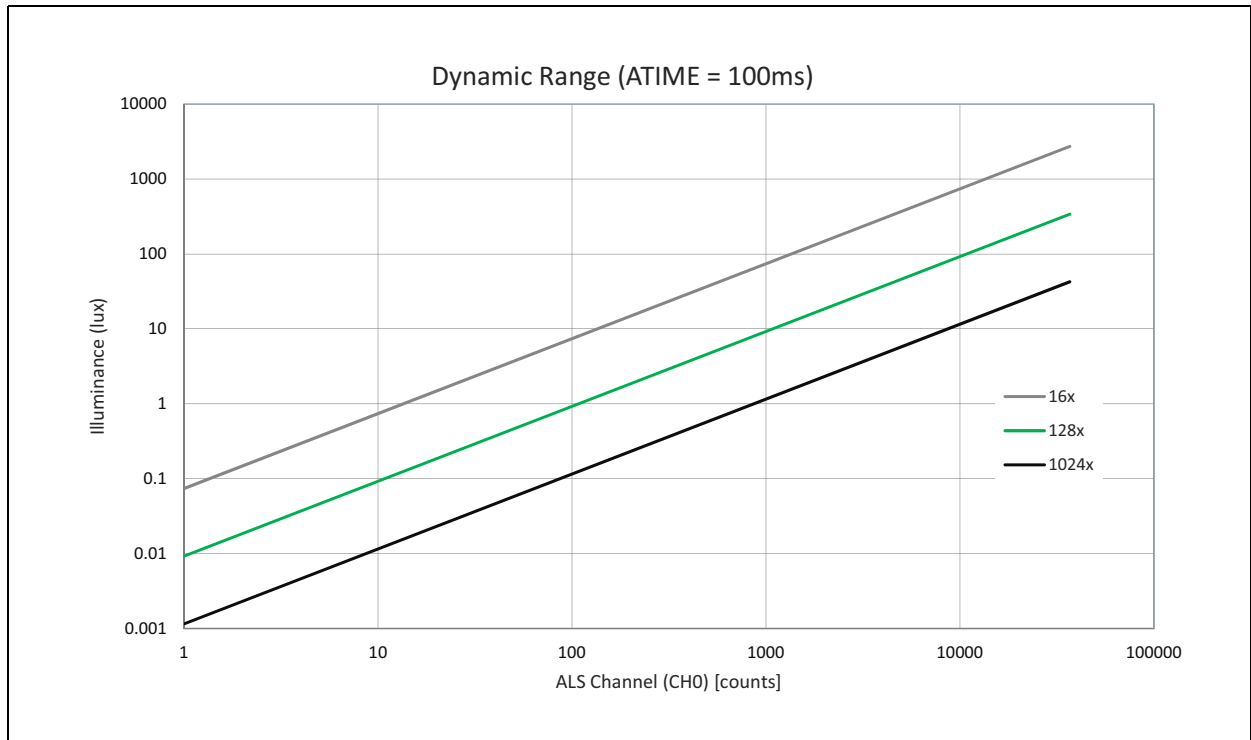

Figure 13:
Illuminance (Lux) vs Counts (ALS Channel (CH0))



Detailed Description

Proximity

Proximity results are affected by three fundamental factors: the integrated IR VCSEL emission, IR reception, and environmental factors, including target distance and surface reflectivity. The IR reception signal path begins with IR detection from a photodiode and ends with the 14-bit proximity result in PDATA register. Signal from the photodiode is amplified, and offset adjusted to optimize performance. Offset correction or cross-talk compensation is accomplished by adjustment to the POFFSET register. The analog circuitry of the device applies the offset value as a subtraction to the signal accumulation; therefore a positive offset value has the effect of decreasing the results.

Ambient Light Sensing, ALS

The ALS reception signal path begins as photodiodes receive filtered light and ends with 16-bit results. Channel 0 contains a photopic filter and channel 1 contains an infrared (IR) filter which is used both for the proximity function and also to accurately measure ambient light levels. Signals from both photodiodes are simultaneously accumulated for a period of time set by the value in ATIME before the results are available. Gain is adjustable by either 128x or 1024x to facilitate operation over a wide range of lighting conditions under dark glass with low transmissivity. Based on the optical glass used on top of the device, custom equations are empirically derived to calculate the amount of ambient light using the ALS results.

Operational State Diagram

Figure 14:
Operational State Diagram

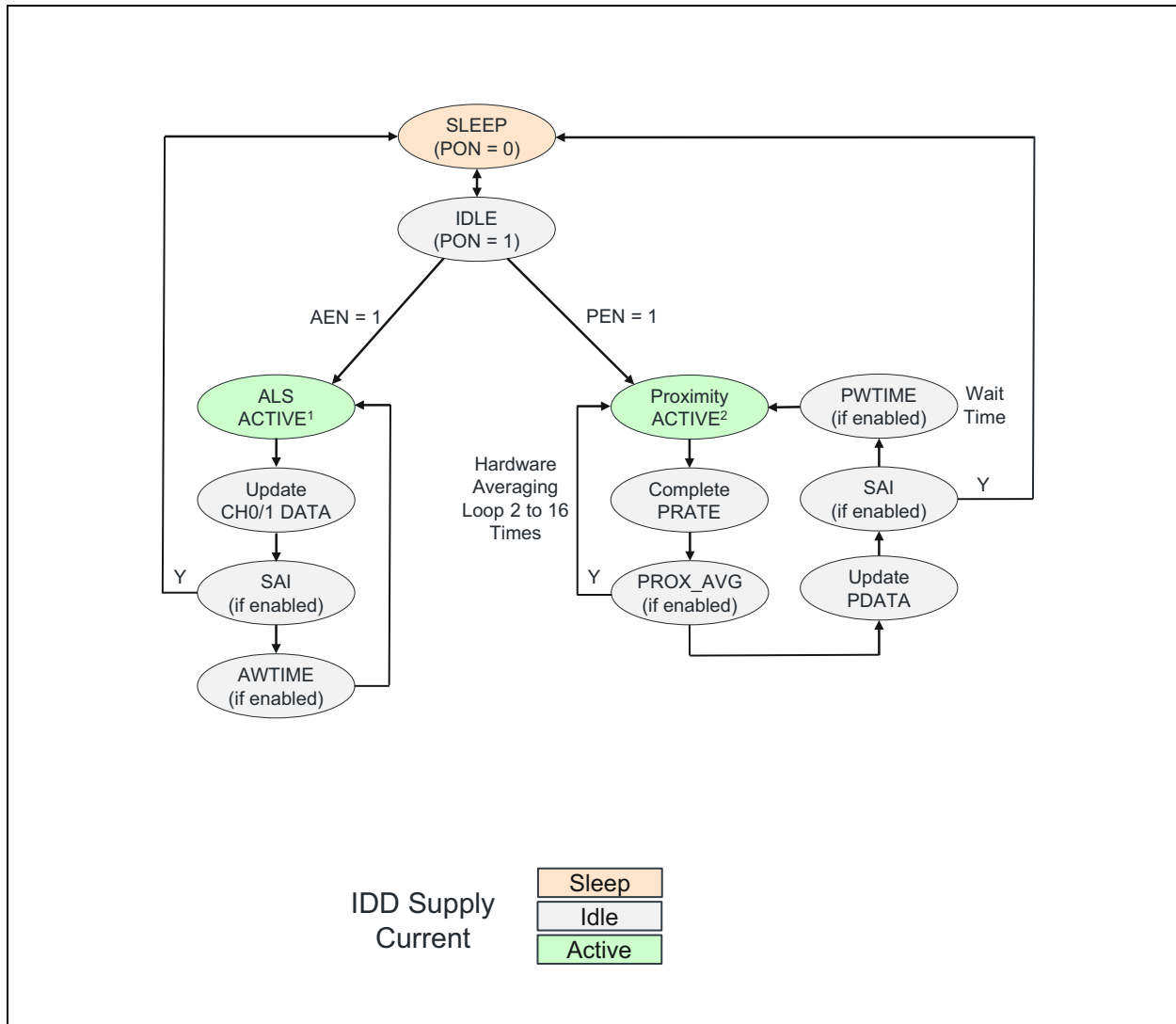

Note(s):

1. ALS active time = ALS integration time (ATIME)
2. Proximity active time = $(7 \times (\text{PULSE_LEN} + 42.15\mu\text{s})) + \text{PPULSE} \times (2 \times \text{PULSE_LEN} + 84.3\mu\text{s}) + 78.75\mu\text{s}$.

I²C Characteristics

The device uses I²C serial communication protocol for communication. The device supports 7-bit chip addressing and both standard and fast clock frequency modes with a chip address of 0x39. Read and write transactions comply with the standard set by Philips (now NXP).

Internal to the device, an 8-bit buffer stores the register address location of the desired byte to read or write. This buffer auto-increments upon each byte transfer and is retained between transaction events (i.e. valid even after the master issues a STOP command and the I²C bus is released). During consecutive Read transactions, the future/repeated I²C Read transaction may omit the memory address byte normally following the chip address byte; the buffer retains the last register address + 1.

I²C Write Transaction

A Write transaction consists of a START, CHIP-ADDRESS_{WRITE}, REGISTER-ADDRESS, DATA BYTE(S), and STOP. Following each byte (9TH clock pulse) the slave places an ACKNOWLEDGE/NOT-ACKNOWLEDGE (ACK/NACK) on the bus. If NACK is transmitted by the slave, the master may issue a STOP.

I²C Read Transaction

A Read transaction consists of a START, CHIP-ADDRESS_{WRITE}, REGISTER-ADDRESS, START, CHIP-ADDRESS_{READ}, DATA BYTE(S), and STOP. Following all but the final byte the master places an ACK on the bus (9TH clock pulse). Termination of the Read transaction is indicated by a NACK being placed on the bus by the master, followed by STOP.

Alternately, if the previous I²C transaction was a Read, the internal register address buffer is still valid, allowing the transaction to proceed without “re”-specifying the register address. In this case the transaction consists of a START, CHIP-ADDRESS_{READ}, DATA BYTE(S), and STOP. Following all but the final byte the master places an ACK on the bus (9TH clock pulse). Termination of the Read transaction is indicated by a NACK being placed on the bus by the master, followed by STOP.

The I²C bus protocol was developed by Philips (now NXP). For a complete description of the I²C protocol, please review the NXP I²C design specification at:

<https://www.i2c-bus.org/references/>

Timing Diagrams

Figure 15:
I²C Timing Diagrams

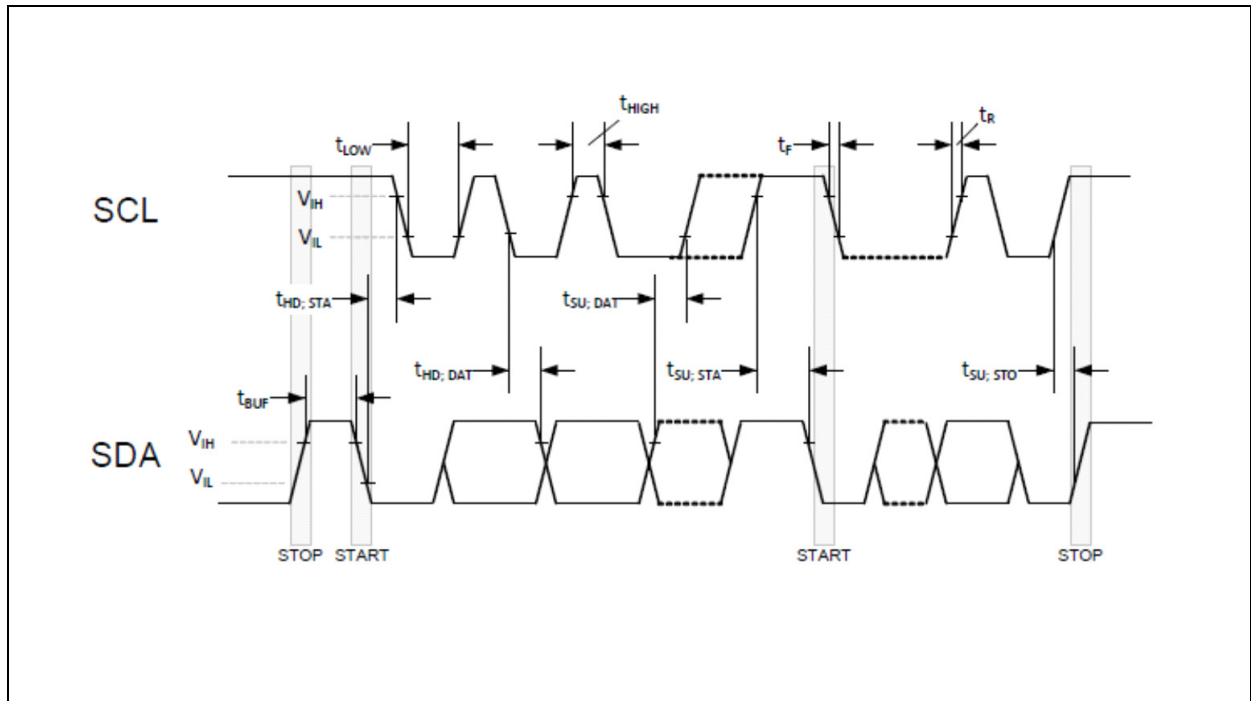

Register Description

Figure 16:
Register Overview

Address	Register Name	R/W	Register Function	Reset Value
0x80	ENABLE	R/W	Enables states and interrupts	0x00
0x81	ATIME	R/W	ADC integration time	0x00
0x82	PRATE	R/W	Proximity time	0x1F
0x83	AWTIME	R/W	ALS wait time	0x00
0x84	AILTL	R/W	ALS interrupt low threshold low byte	0x00
0x85	AILTH	R/W	ALS interrupt low threshold high byte	0x00
0x86	AIHTL	R/W	ALS interrupt high threshold low byte	0x00
0x87	AIHTH	R/W	ALS interrupt high threshold high byte	0x00
0x88	PILTL	R/W	Proximity interrupt low threshold low byte	0x00
0x89	PILTH	R/W	Proximity interrupt low threshold high byte	0x00
0x8A	PIHTL	R/W	Proximity interrupt high threshold low byte	0x00
0x8B	PIHTH	R/W	Proximity interrupt high threshold high byte	0x00
0x8C	PERS	R/W	ALS and proximity interrupt persistence filters	0x00
0x8D	CFG0	R/W	Configuration zero	0x50
0x8E	PCFG0	R/W	Proximity configuration zero	0x8F
0x8F	PCFG1	R/W	Proximity configuration one	0x32
0x90	PCFG2	R/W	Proximity configuration two	0x20
0x91	CFG1	R/W	Configuration one	0x68
0x92	REVID	R	Revision ID	0x00
0x93	ID	R	Device ID	0x50
0x94	STATUS	R, SC	Device status	0x00
0x95	ALSL	R	ALS (CH0) low data	0x00
0x96	ALSH	R	ALS (CH0) high data	0x00
0x97	IRL	R	IR (CH1) low data	0x00
0x98	IRH	R	IR (CH1) high data	0x00
0x99	PDATAAL	R	Proximity ADC low data	0x00
0x9A	PDATAAH	R	Proximity ADC high data	0x00

Address	Register Name	R/W	Register Function	Reset Value
0xA6	REVID2	R	Revision ID two	0x00 or 0x0C
0xA8	SOFRST	R/W	Soft reset	0x00
0xA9	PWTIME	R/W	Proximity wait time	0x00
0xAA	CFG8	R/W	Configuration eight (must be set to 0x29)	0x2A
0xAB	CFG3	R/W	Configuration three	0x01
0xAE	CFG6	R/W	Configuration six	0x3F
0xC0	POFFSETL	R/W	Proximity offset low data	0x00
0xC1	POFFSETH	R/W	Proximity offset high data	0x00
0xD7	CALIB	R/W	Proximity offset calibration	0x00
0xD8	CALIB_OFFSET	R/W	Proximity offset extension	0x00
0xD9	CALIBCFG	R/W	Proximity offset calibration control	0x50
0xDC	CALIBSTAT	R	Proximity offset calibration status	0x00
0xDD	INTENAB	R/W	Interrupt enables	0x00
0xE6	FAC_L	R	Factory data low	0x00 to 0xFF
0xE7	FAC_H	R	Factory data high	0x00 to 0xFF
0xF9	TEST9	R/W	Test nine (must be set to 0x02)	0x0C

Note(s):

1. R = Read Only / W = Write Only / R/W = Read or Write / SC = Self Clearing after access.

Detailed Register Description

Enable Register (Address 0x80)

Figure 17:
Enable Register

Addr: 0x80		Enable		
Bit	Bit Name	Default	Access	Bit Description
7:5	Reserved	0	RW	Reserved. Must be set to default value.
4	PWEN	0	RW	This bit activates the proximity wait feature which is set by the PWTIME register. Active high. ⁽¹⁾
3	AWEN	0	RW	This bit activates the ALS wait feature which is set by the AWTIME register. Active high.
2	PEN	0	RW	This bit activates the proximity detection. Active high.
1	AEN	0	RW	This bit activates the ALS function. Active high.
0	PON	0	RW	This field activates the internal oscillator and ADC channels. Active high.

Note(s):

1. When the ALS function is enabled (AEN = 1), this bit must be set to a one (PWEN = 1).

Before activating AEN or PEN, preset each applicable operating mode registers and bits.

ATIME Register (Address 0x81)

Figure 18:
ATIME Register

Addr: 0x81		ATIME					
Bit	Bit Name	Default	Access	Bit Description			
7:0	ATIME	0x00	RW	The ATIME value specifies the ALS integration time in 2.78ms intervals. 0x00 indicates 2.78ms. The maximum ALS count value depends on the integration time. For every 2.78ms, the maximum value increases by 1024. This means that to be able to reach ALS full scale, the integration time has to be at least 64*2.78ms.			
				Value	Integration Cycles	Integration Time	Maximum ALS Value
				0x00	1	2.78ms	1023
				0x01	2	5.56ms	2047
				0x11	18	50.0ms	18431
				0x23	36	100ms	36863
				0x3F	64	178ms	65535
				0xFF	256	712ms	65535

The ATIME register controls the integration time of the ALS ADCs. The timer is implemented with a down counter with 0x00 as the terminal count. The timer is clocked at a 2.78ms nominal rate. Loading 0x00 will generate a 2.78ms integration time, loading 0x01 will generate a 5.56ms integration time, and so forth.

PRATE Register (Address 0x82)

Figure 19:
PRATE Register

Addr: 0x82		PRATE			
Bit	Bit Name	Default	Access	Bit Description	
7:0	PRATE	0x1F	RW	This register defines the duration of 1 Prox Sample, which is (PRATE + 1)*88μs.	

AWTIME Register (Address 0x83)

Figure 20:
AWTIME Register

Addr: 0x83		AWTIME				
Bit	Bit Name	Default	Access	Bit Description		
7:0	AWTIME	0x00	RW	Value that specifies the wait time in 2.78ms increments.		
				Value	Increments	Wait Time
				0x00	1	2.78ms (33.4ms)
				0x01	2	5.56ms (66.7ms)
				0x11	18	50.0ms (600ms)
				0x23	36	100ms (1.20s)
				0x3F	64	178ms (2.14s)
				0xFF	256	712ms (8.54s)

The wait timer is implemented using a down counter. Wait time = Increment x 2.78ms. If AWLONG is enabled then Wait time = Increment x 2.78ms x 12.

AILTL Register (Address 0x84)

Figure 21:
AILTL Register

Addr: 0x84		AILTL			
Bit	Bit Name	Default	Access	Bit Description	
7:0	AILTL	0x00	RW	This register sets the low byte of the LOW ALS threshold.	

AILTH Register (Address 0x85)

Figure 22:
AILTH Register

Addr: 0x85		AILTH			
Bit	Bit Name	Default	Access	Bit Description	
7:0	AILTH	0x00	RW	This register sets the high byte of the LOW ALS threshold.	

The ALS (CH0) channel is compared against low-going 16-bit threshold value set by AILTL and AILTH.

The contents of the AILTH and AILTL registers are combined and treated as a sixteen bit threshold value. If the value generated by the ALS channel (CH0) is below the AILTL/H threshold and the APERS value is reached, the AINT bit is asserted. If AIEN is set, then the INT pin will also assert. When setting the 16-bit ALS threshold AILTL must be written first, immediately followed by AILTH. Internally, the lower 8-bits are buffered until the upper 8-bits are written. As the upper 8-bits are written both the high and low bytes are simultaneously latched as a 16-bit value.

AIHTL Register (Address 0x86)

Figure 23:
AIHTL Register

Addr: 0x86		AIHTL		
Bit	Bit Name	Default	Access	Bit Description
7:0	AIHTL	0x00	RW	This register sets the low byte of the HIGH ALS threshold.

AIHTH Register (Address 0x87)

Figure 24:
AIHTH Register

Addr: 0x87		AIHTH		
Bit	Bit Name	Default	Access	Bit Description
7:0	AIHTH	0x00	RW	This register sets the high byte of the HIGH ALS threshold.

The ALS (CH0) channel is compared against high-going 16-bit threshold value set by AIHTL and AIHTH.

The contents of the AIHTH and AIHTL registers are combined and treated as a sixteen bit threshold value. If the value generated by the ALS channel (CH0) is above the AIHTL/H threshold and the APERS value is reached, the AINT bit is asserted. If AIEN is set, then the INT pin will also assert. When setting the 16-bit ALS threshold AIHTL must be written first, immediately followed by AIHTH. Internally, the lower 8-bits are buffered until the upper 8-bits are written. As the upper 8-bits are written both the high and low bytes are simultaneously latched as a 16-bit value.

PILTL Register (Address 0x88)

Figure 25:
PILTL Register

Addr: 0x88		PILTL		
Bit	Bit Name	Default	Access	Bit Description
7:0	PILTL	0x00	RW	This register contains the low byte of the 14-bit proximity LOW threshold when APC is enabled. If APC is disabled, this register contains the LOW threshold which is an 8-bit value which is compared against the upper 8-bits of the 10-bit proximity value.

PILTH Register (Address 0x89)

Figure 26:
PILTH Register

Addr: 0x89		PILTH		
Bit	Bit Name	Default	Access	Bit Description
7:6	Reserved	00	RW	Reserved. Must be set to default value.
5:0	PILTH	0x00	RW	This register contains the upper 6 bits of the 14-bit proximity LOW threshold when APC is enabled. If APC is disabled, this register is ignored.

The contents of the PILTH and PILTL registers are combined and treated as a fourteen (14) bit threshold low value. If the value generated by the proximity ADC (PDATA) is below the PILTL/H threshold and the PPERS value is reached, then the low proximity threshold is breached. When setting the 14-bit proximity threshold, PILTL must be written first, immediately follow by PILTH. Internally, the lower 8-bits are buffered until the upper 8-bits are written. As the upper 8-bits are written both the high and low bytes are simultaneously latched as a 14-bit value.

If Automatic Pulse Control (APC) is disabled by setting bit 6 in CFG6 to 1, then the proximity data converts to a 10-bit value. PILTL contains an 8-bit threshold which is compared against the upper 8-bits of the 10-bit value. PILTH is ignored.

PIHTL Register (Address 0x8A)

Figure 27:
PIHTL Register

Addr: 0x8A		PIHTL		
Bit	Bit Name	Default	Access	Bit Description
7:0	PIHTL	0x00	RW	This register contains the low byte of the 14-bit proximity HIGH threshold when APC is enabled. If APC is disabled, this register contains the HIGH threshold which is an 8-bit value which is compared against the upper 8-bits of the 10-bit proximity value.

PIHTH Register (Address 0x8B)

Figure 28:
PIHTH Register

Addr: 0x8B		PIHTH		
Bit	Bit Name	Default	Access	Bit Description
7:6	Reserved	00	RW	Reserved. Must be set to default value.
5:0	PIHTH	0x00	RW	This register contains the upper 6 bits of the 14-bit proximity HIGH threshold when APC is enabled. If APC is disabled, this register is ignored.

The contents of the PIHTH and PIHTL registers are combined and treated as a fourteen (14) bit threshold high value. If the value generated by the proximity ADC (PDATA) is above the PIHTL/H threshold and the PPRS value is reached, then the high proximity threshold is breached. When setting the 14-bit proximity threshold, PIHTL must be written first, immediately follow by PIHTH. Internally, the lower 8-bits are buffered until the upper 8-bits are written. As the upper 8-bits are written both the high and low bytes are simultaneously latched as a 14-bit value.

If Automatic Pulse Control (APC) is disabled by setting bit 6 in CFG6 to 1, then the proximity data converts to a 10-bit value. PIHTL contains an 8-bit threshold which is compared against the upper 8-bits of the 10-bit value. PIHTH is ignored.

PERS Register (Address 0x8C)
Figure 29:
PERS Register

Addr: 0x8C		PERS			
Bit	Bit Name	Default	Access	Bit Description	
7:4	PPERS	0 (0000)	RW	This register sets the proximity persistence filter.	
				Value	Interrupt
				0 (0000)	Every proximity cycle
				1 (0001)	Any value outside proximity thresholds
				2 (0010)	2 consecutive proximity values out of range
				3 (0011)	3 consecutive proximity values out of range
			
				15 (1111)	15 consecutive proximity values out of range
3:0	APERS	0 (0000)	RW	This register sets the ALS persistence filter.	
				0 (0000)	Every ALS cycle
				1 (0001)	Any value outside ALS thresholds
				2 (0010)	2 consecutive ALS values out of range
				3 (0011)	3 consecutive ALS values out of range
				4 (0100)	5 consecutive ALS values out of range
				5 (0101)	10 consecutive ALS values out of range
				6 (0110)	15 consecutive ALS values out of range
				7 (0111)	20 consecutive ALS values out of range
			
				13 (1101)	50 consecutive ALS values out of range
				14 (1110)	55 consecutive ALS values out of range
				15 (1111)	60 consecutive ALS values out of range

The frequency of consecutive proximity channel results outside of threshold limits are counted; this count value is compared against the PPERS value. If the counter is equal to the PPERS value an interrupt is asserted. Any time a proximity channel result is inside the threshold values the counter is cleared.

The frequency of consecutive ALS (CH0) channel results outside of threshold limits are counted; this count value is compared against the APERS value. If the counter is equal to the APERS setting an interrupt is asserted. Any time an ALS (CH0) channel result is inside the threshold values the counter is cleared.

CFG0 Register (Address 0x8D)

Figure 30:
CFG0 Register

Addr: 0x8D		CFG0		
Bit	Bit Name	Default	Access	Bit Description
7:4	Reserved	0101	RW	Reserved. Must be set to default value.
3	PWLONG	0	RW	When PWLONG (PROX Wait Long) is asserted the wait period as set by PWTIME is increased by a factor of 12.
2	AWLONG	0	RW	When AWLONG (ALS Wait Long) is asserted the wait period as set by AWTIME is increased by a factor of 12.
1:0	Reserved	00	RW	Reserved. Must be set to default value.

PCFG0 Register (Address 0x8E)
Figure 31:
 PCFG0 Register

Addr: 0x8E		PCFG0			
Bit	Bit Name	Default	Access	Bit Description	
7:6	PGAIN1	2 (10)	RW	This field along with the PGAIN2 bits in the CFG1 register, sets the gain of the proximity IR sensor.	
				Value	Stage 1 Gain
				0 (00)	1x
				1 (01)	2x
				2 (10)	4x
				3 (11)	8x
5:0	PPULSE	15 (001111)	RW	Maximum number of pulses in a single proximity cycle.	
				Value	Maximum Number of Pulses
				0 (000000)	1
				1 (000001)	2
				2 (000010)	3
			
				63 (111111)	64

The PPULSE field sets the maximum number of IR VCSEL pulses that may occur in a proximity cycle. The proximity engine will automatically continue to add IR VCSEL pulses, up to the value set in PPULSE or if a near-saturation condition occurs if Automatic Pulse Control (APC) is enabled. The dynamic range of the sensor is automatically adjusted to detect distant targets as well as prevent saturation from close targets. This operation also reduces power consumption because proximity integration period is automatically shortened when a target is close to the sensor.

If Automatic Pulse Control (APC) is disabled by setting bit 6 in CFG6 to 1, then PPULSE always determines the number of proximity pulses to be transmitted.

PCFG1 Register (Address 0x8F)

Figure 32:
PCFG1 Register

Addr: 0x8F		PCFG1			
Bit	Bit Name	Default	Access	Bit Description	
7:6	PPULSE_LENH	00	RW	These bits are the 2 most significant bits of the 10-bit Pulse Length control setting. The lower 8 bits are in the PCFG2 register. See the PCFG2 register for details.	
5:4	Reserved	11	RW	Reserved. Must be set to default value.	
3:0	PLDRIVE	2 (0010)	RW	This field sets the drive strength of the IR VCSEL current. Values are approximate; actual current through the VCSEL is factory trimmed to normalize IR intensity.	
				Value	VCSEL Current
				5 (0101)	7mA
				6 (0110)	8mA
				7 (0111)	9mA
				8 (1000)	10mA
All other values	Reserved				

PCFG2 Register (Address 0x90)

Figure 33:
PCFG2 Register

Addr: 0x90		PCFG2			
Bit	Bit Name	Default	Access	Bit Description	
7:0	PPULSE_LENH	0x20	RW	These bits are the 8 least significant bits of the 10-bit Pulse Length control setting. The upper 2 bits are in the PCFG1 register. The minimum pulse length is 32μs.	
				Value	Pulse Length
				30 (0000011110)	32μs
				31 (0000011111)	33μs
				Pulse Length = (PULSE_LEN + 2) μs	
1023 (1111111111)	1025μs				

CFG1 Register (Address 0x91)
Figure 34:
 CFG1 Register

Addr: 0x91		CFG1			
Bit	Bit Name	Default	Access	Bit Description	
7	Reserved	0	RW	Reserved. Must be set to default value.	
6:5	PGAIN2	3 (11)	RW	This field along with the PGAIN1 bits in the PCFG0 register, sets the gain of the proximity IR sensor.	
				Value	Stage 2 Gain
				0 (00)	2.5x
				1 (01)	5x
				2 (10)	Reserved
4:0	AGAIN	8 (01000)	RW	This field sets the gain of the ALS sensor.	
				Value	ALS Gain
				5 (00101)	16x
				8 (01000)	128x
				11 (01011)	1024x
	All other values	Reserved			

REVID Register (Address 0x92)
Figure 35:
 REVID Register

Addr: 0x92		REVID		
Bit	Bit Name	Default	Access	Bit Description
7:3	Reserved	00000	R	Reserved.
2:0	REV_ID	000	R	Device revision number.

ID Register (Address 0x93)**Figure 36:**
ID Register

Addr: 0x93		ID		
Bit	Bit Name	Default	Access	Bit Description
7:2	ID	010100	R	Device type identification.
1:0	Reserved	00	R	Reserved

STATUS Register (Address 0x94)**Figure 37:**
STATUS Register

Addr: 0x94		STATUS Register		
Bit	Bit Name	Default	Access	Bit Description
7	ASAT	0	R, SC	Analog saturation flag signals that the ALS results may be unreliable due to saturation of the AFE.
6	PSAT	0	R, SC	Proximity saturation flag indicates that an ambient- or reflective-saturation event occurred during a previous proximity cycle.
5	PINT	0	R, SC	Proximity interrupt flag indicates that proximity results have exceeded thresholds and persistence settings.
4	AINT	0	R, SC	ALS interrupt flag indicates that ALS results (CH0) have exceeded thresholds and persistence settings.
3	CINT	0	R, SC	Calibration interrupt flag indicates that calibration has completed.
2	ZINT	0	R, SC	Zero detection interrupt flag indicates that a zero value in PDATA has caused the proximity offset to be decremented (if AUTO_OFFSET_ADJ = 1).
1	PSAT_REFLECTIVE	0	R, SC	The Reflective Proximity Saturation Interrupt flag signals that the AFE has saturated during the IR VCSEL active portion of proximity integration.
0	PSAT_AMBIENT	0	R, SC	The Ambient Proximity Saturation Interrupt flag signals that the AFE has saturated during the IR VCSEL inactive portion of proximity integration.

All flags in this register can be cleared by setting the bit high. Alternatively, if the INT_READ_CLEAR in the CFG3 register bit is set, then simply reading this register automatically clears all eight flags.

ALSL Register (Address 0x95)

Figure 38:
ALSL Register

Addr: 0x95		ALSL		
Bit	Bit Name	Default	Access	Bit Description
7:0	ALSL	0x00	R	This register contains the low byte of the 16-bit ALS channel (CH0) data.

ALSH Register (Address 0x96)

Figure 39:
ALSH Register

Addr: 0x96		ALSH		
Bit	Bit Name	Default	Access	Bit Description
7:0	ALSH	0x00	R	This register contains the high byte of the 16-bit ALS channel (CH0) data.

IRL Register (Address 0x97)

Figure 40:
IRL Register

Addr: 0x97		IRL		
Bit	Bit Name	Default	Access	Bit Description
7:0	IRL	0x00	R	This register contains the low byte of the 16-bit IR channel (CH1) data.

IRH Register (Address 0x98)

Figure 41:
IRH Register

Addr: 0x98		IRH		
Bit	Bit Name	Default	Access	Bit Description
7:0	IRH	0x00	R	This register contains the high byte of the 16-bit IR channel (CH1) data.

PDATA Register (Address 0x99)

Figure 42:
PDATA Register

Addr: 0x99		PDATA		
Bit	Bit Name	Default	Access	Bit Description
7:0	PDATA	0x00	R	This register contains the low byte of the 14-bit proximity ADC data when APC is enabled. If APC is disabled, this register contains the upper 8 most significant bits of the 10-bit proximity value.

PDATAH Register (Address 0x9A)

Figure 43:
PDATAH Register

Addr: 0x9A		PDATAH		
Bit	Bit Name	Default	Access	Bit Description
7:0	PDATAH	0x00	R	This register contains the high byte of the 14-bit proximity ADC data when APC is enabled. If APC is disabled, bits 1:0 contain the lower 2 bits of the 10-bit proximity value.

Proximity data is stored as a 14-bit value (two bytes). Reading the low byte first latches the high byte. Proximity detection uses an Automatic Pulse Control (APC) mechanism that adjusts the number of pulses per measurement based on the magnitude of the reflected IR signal. As the magnitude of the signal increases, the number of pulses decreases. Proximity detection uses a 10-bit ADC that is extended to a 14-bit dynamic range for PDATA using the following formula:

$$PDATA = ADC_{value} \times (16 / \text{actual number of pulses transmitted})$$

PDATA is therefore proportional to the reflected energy independent of the number of pulses transmitted.

If Automatic Pulse Control (APC) is disabled by setting bit 6 in CFG6 to 1, then the proximity data converts to a 10-bit value. PDATA contains the 8 most significant bits of the 10-bit value and PDATAH bit locations 1:0 contain the lower 2-bits. When APC is disabled, only the upper 8-bits are compared against the threshold values contained in PILTL and PIHTL.

REVID2 Register (Address 0xA6)
Figure 44:
REVID2 Register

Addr: 0xA6		REVID2		
Bit	Bit Name	Default	Access	Bit Description
7:4	Reserved	0000	R	Reserved.
3:0	VER_ID	0000 or 1100	R	Device version number.

SOFTRST Register (Address 0xA8)
Figure 45:
SOFTRST Register

Addr: 0xA8		SOFTRST		
Bit	Bit Name	Default	Access	Bit Description
7:2	Reserved	0	RW	Reserved. Must be set to default value.
1	POR	0	RW	Writing a 1 to this bit will cause a power on reset. This will immediately terminate all device operation and put the device into the sleep state.
0	SOFTRST	0	RW	Writing a 1 to this bit will cause all registers to be reset to their default state. This will immediately terminate all device operation and put the device into the sleep state.

PWTIME Register (Address 0xA9)

Figure 46:
PWTIME Register

Addr: 0xA9		PWTIME				
Bit	Bit Name	Default	Access	Bit Description		
7:0	PWTIME	0x00	RW	Value that specifies the wait time in 2.78ms increments.		
				Value	Increments	Wait Time
				0x00	1	2.78ms (33.4ms)
				0x01	2	5.56ms (66.7ms)
				0x11	18	50.0ms (600ms)
				0x23	36	100ms (1.20s)
				0x3F	64	178ms (2.14s)
				0xFF	256	712ms (8.54s)

The wait timer is implemented using a down counter. Wait time = Increment x 2.78ms. If PWLONG is enabled then Wait time = Increment x 2.78ms x 12.

CFG8 Register (Address 0xAA)

Figure 47:
CFG8 Register

Addr: 0xAA		CFG8		
Bit	Bit Name	Default	Access	Bit Description
7:0	Reserved	0x2A	RW	Reserved. Must be set to 0x29.

CFG3 Register (Address 0xAB)

Figure 48:
CFG3 Register

Addr: 0xAB		CFG3					
Bit	Bit Name	Default	Access	Bit Description			
7	INT_READ_CLEAR	0	RW	If set, then flag bits in the STATUS register will be reset whenever the STATUS register is read over I ² C.			
6:5	Reserved	0	RW	Reserved. Must be set to default value.			
4	SAI	0	RW	The Sleep After Interrupt bit is used to place the device into a low power mode upon an interrupt pin assertion.			
				PON	SAI	INT	Oscillator
				0	X	X	OFF
				1	0	X	ON
				1	1	1	ON
1	1	0	OFF				
3:0	Reserved	0001	RW	Reserved. Must be set to default value.			

The SAI bit sets the device operational mode following the completion of an ALS or proximity cycle. If AINT and AIEN are both set or if PINT and PIEN are both set, causing an interrupt on the INT pin, and the SAI bit is set, then the oscillator will deactivate. The device will appear as if PON = 0, however, PON will read as 1. The device can only be reactivated (oscillator enabled) by clearing the interrupts in the STATUS register.

CFG6 Register (Address 0xAE)

Figure 49:
CFG6 Register

Addr: 0xAE		CFG6			
Bit	Bit Name	Default	Access	Bit Description	
7	Reserved	0	RW	Reserved. Must be set to default value.	
6	APC_DISABLE	0	RW	Proximity automatic pulse control (APC) disable. 0 = APC enable 1 = APC disable	
5:0	Reserved	111111	RW	Reserved. Must be set to default value.	

POFFSETL Register (Address 0xC0)

Figure 50:
POFFSETL Register

Addr: 0xC0		POFFSETL		
Bit	Bit Name	Default	Access	Bit Description
7:0	POFFSETL	0x00	RW	This register contains the magnitude portion of proximity offset adjust value.

POFFSETH Register (Address 0xC1)

Figure 51:
POFFSETH Register

Addr: 0xC1		POFFSETH		
Bit	Bit Name	Default	Access	Bit Description
7:1	Reserved	0	RW	Reserved. Must be set to default value.
0	POFFSETH	0	RW	This register contains the sign portion of proximity offset adjust value.

Typically, optical and/or electrical crosstalk negatively influence proximity operation and results. The POFFSETL/POFFSETH registers provide a mechanism to remove system crosstalk from the proximity data. POFFSETL and POFFSETH contains the magnitude and sign of a value which adjusts PDATA is generated in the AFE. An offset value in the range of ± 255 is possible.

CALIB Register (Address 0xD7)
**Figure 52:
CALIB Register**

Addr: 0xD7		CALIB		
Bit	Bit Name	Default	Access	Bit Description
7	CALAVG	0	RW	Enables proximity hardware averaging as selected with PROX_AVG during calibration. 0 = No hardware averaging 1 = Hardware averaging enabled
6	Reserved	0	RW	Reserved. Must be set to default value.
5	ELECTRICAL_CALIBRATION	0	RW	Selects proximity calibration type. 0 = Electrical and optical crosstalk. 1 = Electrical crosstalk only.
4	CALPRATE	0	RW	Enables PRATE during calibration. Useful when averaging is enabled. 0 = PRATE ignored 1 = PRATE applied between averaging samples
3:1	Reserved	0	RW	Reserved. Must be set to default value.
0	START_OFFSET_CAL	0	RW	Set to 1 to start a calibration sequence.

Proximity response in systems with electrical and optical crosstalk may be improved by using the calibration feature. Optical crosstalk is caused when the photodiode receives a portion of the VCSEL IR which was unintentionally reflected by a surface other than the target. Electrical offset is caused by electrical disturbance in the sensor AFE, and also influences the proximity result. The calibration routine adjusts the value in POFFSETL/H until the proximity result is as close to the binary search target as possible. Optical and electrical calibration function identically, except that during an electrical calibration the proximity photodiode is disconnected from the AFE. An electrical calibration can be initiated anytime by setting the ELECTRICAL_CALIBRATION and START_OFFSET_CAL bits. To perform an optical (and electrical) calibration do not set the ELECTRICAL_CALIBRATION bit when setting the START_OFFSET_CALIB. The CINT flag will assert after calibration has finished. Upon completion proximity offset registers are automatically loaded with calibration result.

CALIB_OFFSET Register (Address 0xD8)

Figure 53:
CALIB_OFFSET Register

Addr: 0xD8		CALIB_OFFSET			
Bit	Bit Name	Default	Access	Bit Description	
7:6	Reserved	0	RW	Reserved. Must be set to default value.	
5	EN_RANGE_EXTENSION	0	RW	Setting this bit to a 1 enables the proximity offset range extension functionality. See the OFFSET_RANGE_EXTENSION bits. If this bit is set to 0, the offset range extension is disabled.	
4:0	OFFSET_RANGE_EXTENSION	0 (00000)	RW	Offset range extension selection.	
				Value	Selection
				0 (00000)	Nominal
				1 (00001)	Nominal + 1 Step
				2 (00010)	Nominal + 2 Steps
				3 (00011)	Nominal + 3 Steps
				Nominal + (Value) Steps	
				31 (11111)	Nominal + 31 Steps

For applications with high optical proximity crosstalk (the emitted IR optical signal appears at the IR sensor), the offset range can be extended in discrete steps. To determine the best range extension step for the application, a proximity calibration cycle is initiated and the resulting proximity offset is captured in the POFFSETL/H registers.

CALIBCFG Register (Address 0xD9)
Figure 54:
CALIBCFG Register

Addr: 0xD9		CALIBCFG			
Bit	Bit Name	Default	Access	Bit Description	
7:5	BINSRCH_TARGET	2 (010)	RW	Proximity offset calibration result target.	
				Value	PDATA Target
				0 (000)	3
				1 (001)	7
				2 (010)	15
				3 (011)	31
				4 (100)	63
				5 (101)	127
				6 (110)	255
7 (111)	511				
4	Reserved	1	RW	Reserved. Must be set to default value.	
3	AUTO_OFFSET_ADJ	0	RW	If set, this bit causes the value in POFFSETL register to be decremented if PDATA ever becomes zero.	
2:0	PROX_AVG	0 (000)	RW	PROX_AVG defines the number of ADC samples collected and hardware averaged during a proximity cycle.	
				Value	Sample Size
				0 (000)	Disable
				1 (001)	2
				2 (010)	4
				3 (011)	8
				4 (100)	16
				All other values	Reserved

The binary search target field is used by the calibration feature to set the baseline value for PDATA when no target is present. For example, calibration of a device in open air, with no target, and BINSEARCH_TARGET setting of 2 causes the PDATA value to be approximately 15 counts. This feature is useful because it forces PDATA result to always be above zero.

The PROX_AVG field sets the number of ADC samples that are averaged. Each ADC sample causes the programmed number of proximity pulses to be transmitted. Once all samples have been completed and the average is calculated, the proximity state machine will then pass this value directly to PDATA.

CALIBSTAT Register (Address 0xDC)

Figure 55:
CALIBSTAT Register

Addr: 0xDC		CALIBSTAT		
Bit	Bit Name	Default	Access	Bit Description
7:3	Reserved	0	R	Reserved. Must be set to default value.
2	OFFSET_ADJUSTED	0	R	Bit is set when the proximity offset has been automatically decremented if AUTO_OFFSET_ADJ = 1 (see CALIBCFG register). This bit can be cleared by writing 1 to it or setting AUTO_OFFSET_ADJ to 0.
1	Reserved	0	R	Reserved. Must be set to default value.
0	CALIB_FINISHED	0	R	This flag indicates that calibration has finished. This bit is a copy of the CINT bit in the STATUS register. It will be cleared when the CINT bit is cleared.

INTENAB Register (Address 0xDD)

Figure 56:
INTENAB Register

Addr: 0xDD		INTENAB		
Bit	Bit Name	Default	Access	Bit Description
7	ASIEN	0	RW	ALS Saturation Interrupt Enable
6	PSIEN	0	RW	Proximity Saturation Interrupt Enable
5	PIEN	0	RW	Proximity Interrupt Enable
4	AIEN	0	RW	ALS Interrupt Enable
3	CIEN	0	RW	Calibration Interrupt Enable
2	ZIEN	0	RW	Zero Detect Interrupt Enable
1:0	Reserved	0	RW	Reserved. Must be set to default value.

FAC_L Register (Address 0xE6)

Figure 57:
FAC_L Register

Addr: 0xE6		FAC_L		
Bit	Bit Name	Default	Access	Bit Description
7:0	Reserved	0x00 – 0xFF	R	Reserved for factory use.

FAC_H Register (Address 0xE7)

Figure 58:
FAC_H Register

Addr: 0xE7		FAC_H		
Bit	Bit Name	Default	Access	Bit Description
7:0	Reserved	0x00 – 0xFF	R	Reserved for factory use.

TEST9 Register (Address 0xF9)

Figure 59:
TEST9 Register

Addr: 0xF9		TEST9		
Bit	Bit Name	Default	Access	Bit Description
7:0	Reserved	0x0C	R/W	Reserved. Must be set to 0x02.

Application Information

Schematic

Figure 60:
Typical Applications Circuit

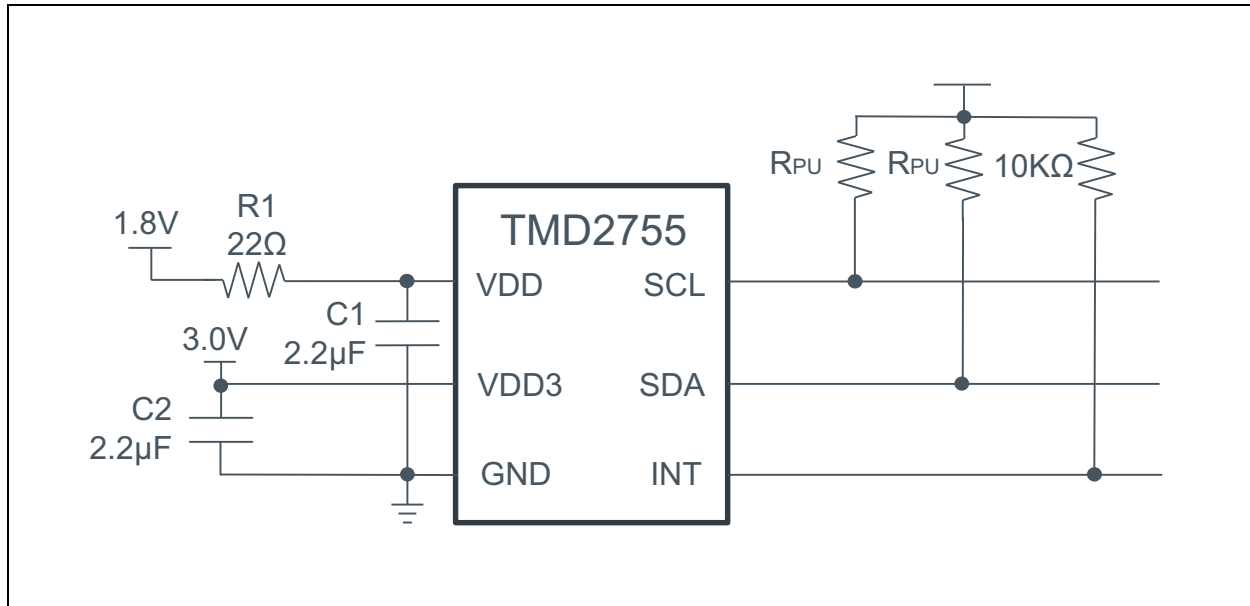

Note(s):

1. Place the 2.2μF VDD (C1) and 2.2μF VDD3 (C2) capacitors within 5mm of the module.
2. The value of the I²C pull up resistors (R_{PU}) should be based on the 1.8V bus voltage, system bus speed and trace capacitance.
3. C1 and C2 are critical components to protect the device during high voltage ESD strikes.
4. In systems subjected to high voltage ESD strikes, it is recommended to connect VDD to a host GPIO pin to allow the device to be independently power cycled.

Recommended Circuit Layout

Figure 61:
With INT Pin Operational

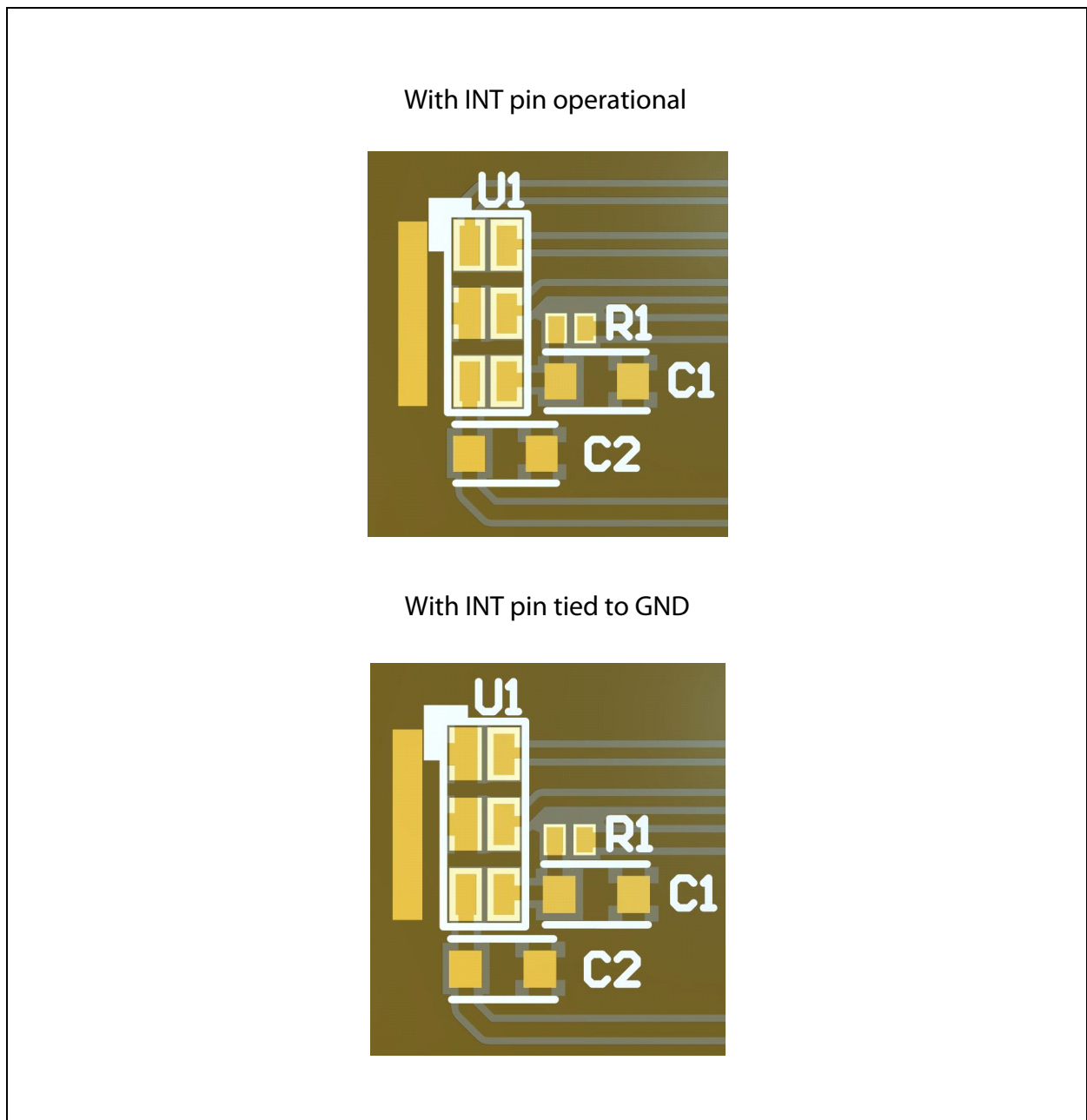

Note(s):

1. The dominant factor governing device performance is the component placement, not necessarily component value. The placement of the decoupling capacitor, C1, is the most critical. Place the component on the same side of PCB as device as shown in the figure above. Make connection as close as possible to minimize series inductance and resistance. This is critical.

Package Drawings & Markings

Figure 62:
Package Drawings

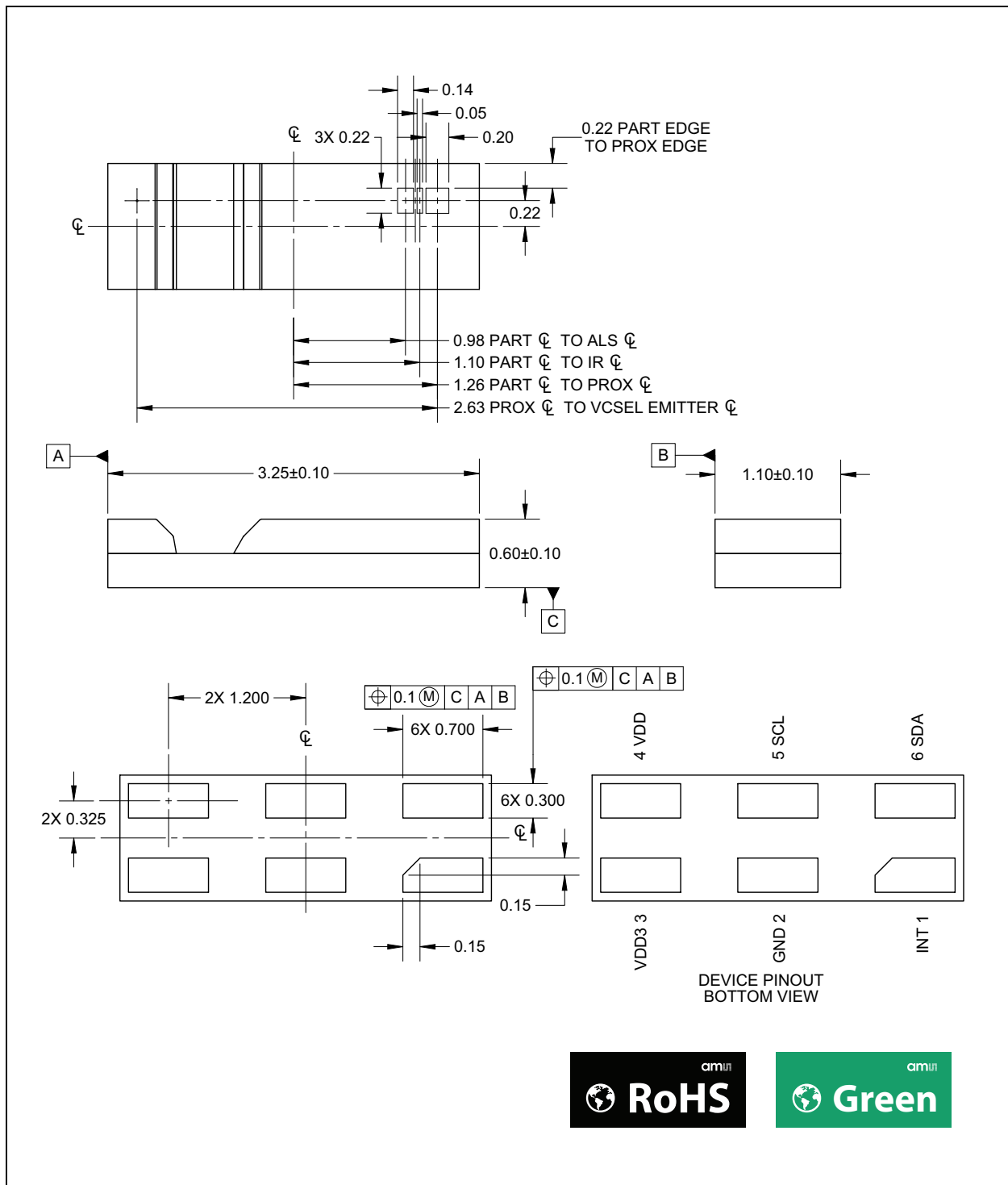

Note(s):

1. All linear dimensions are in millimeters.
2. Dimension tolerances are ±0.05mm unless otherwise noted.
3. Contact finish is Au.
4. This package contains no lead (Pb).
5. This drawing is subject to change without notice.

Recommended PCB Pad Layout

Suggested PCB pad layout guidelines for the surface mount module are shown. Flash Gold is recommended as a surface finish for the landing pads.

Figure 63:
Recommended PCB Pad Layout

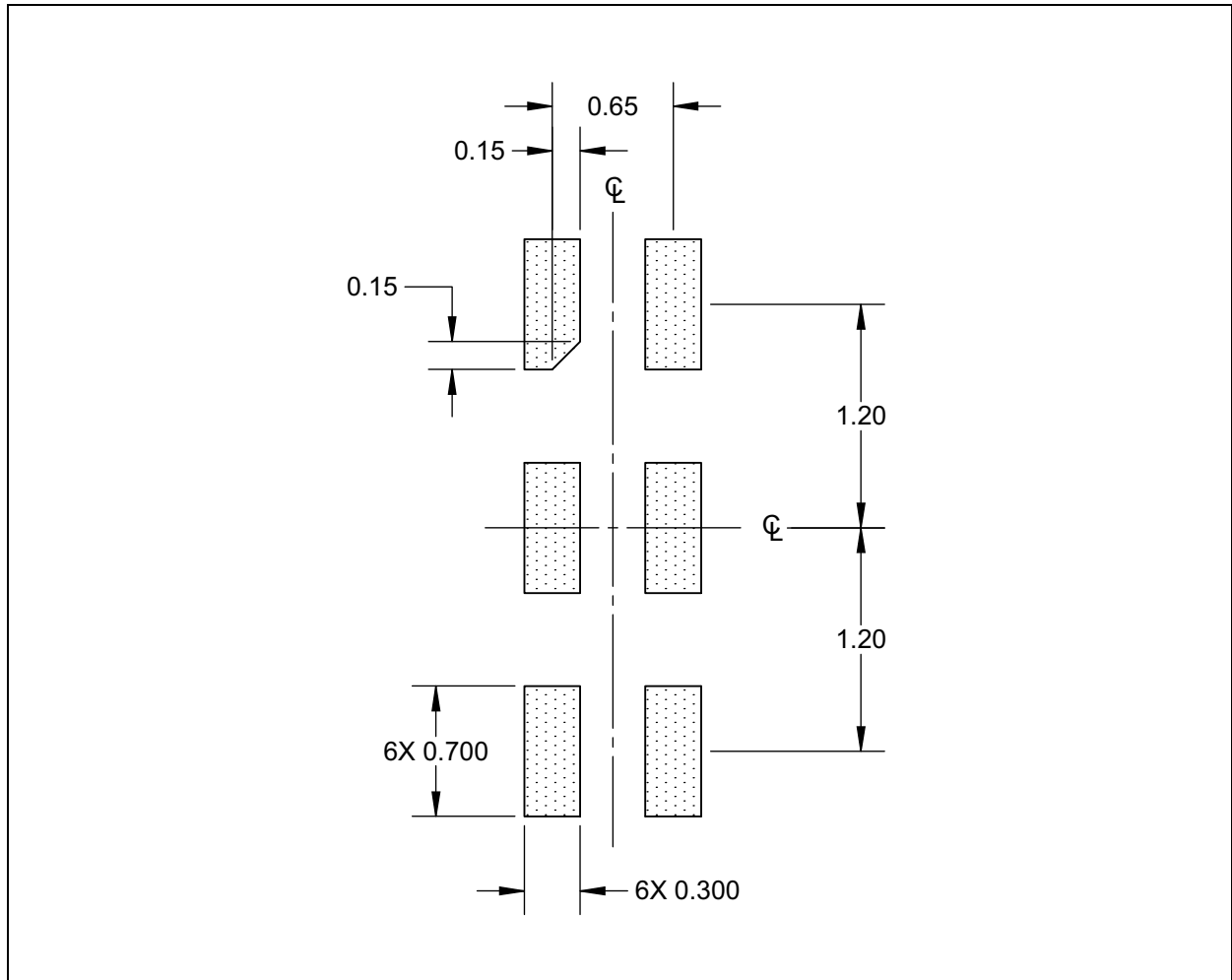

Note(s):

1. All Linear Dimensions are in millimeters.
2. Dimension tolerances are 0.05mm unless otherwise noted.
3. Contact finish is Au.
4. This drawing is subject to change without notice.

Tape & Reel Information

Figure 64:
Tape and Reel Information

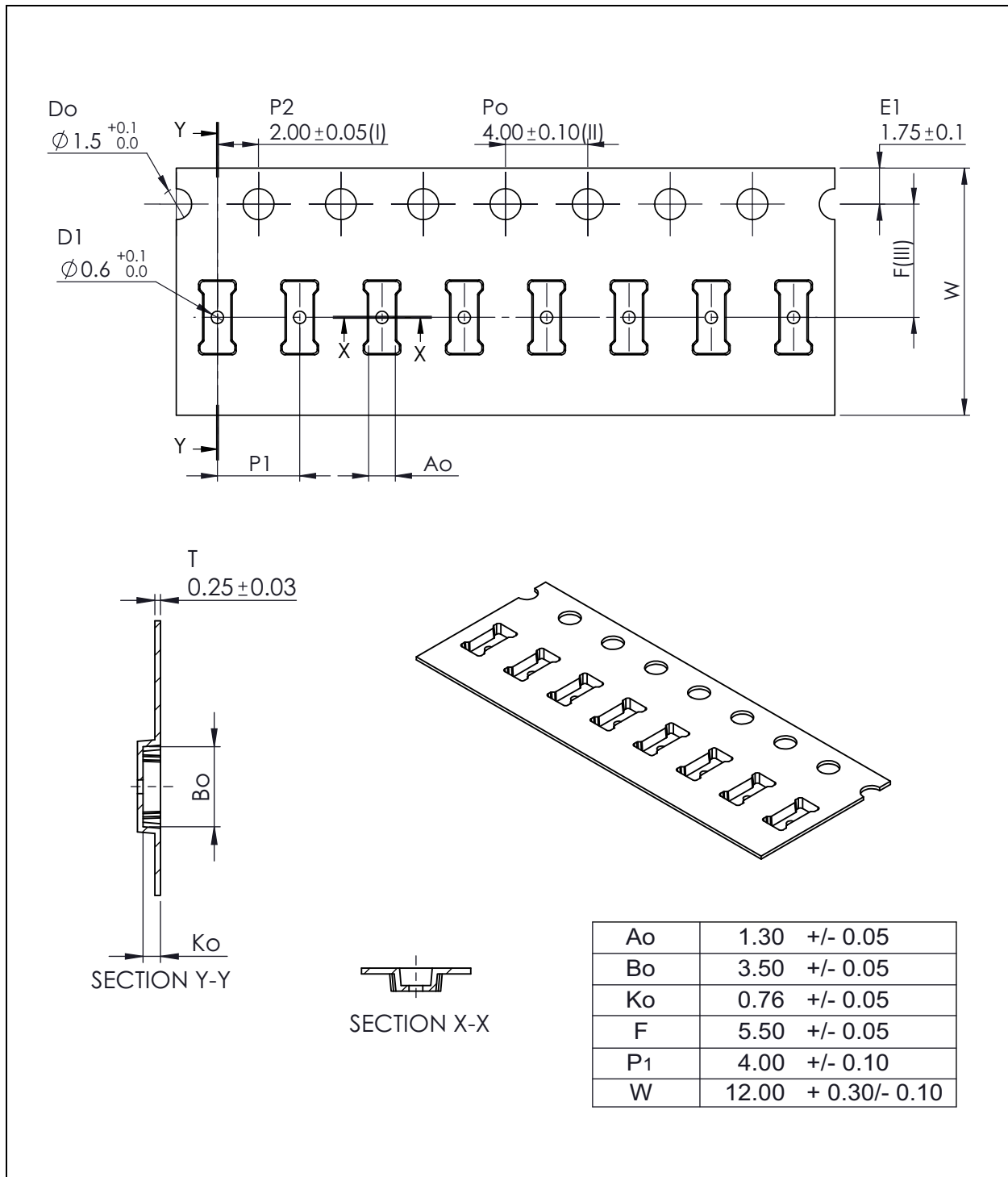

Note(s):

1. All linear dimensions are in millimeters. Dimension tolerance is $\pm 0.10\text{mm}$ unless otherwise noted.
2. The dimensions on this drawing are for illustrative purposes only. Dimensions of an actual carrier may vary slightly.
3. Symbols on drawing Ao, Bo, and Ko are defined in ANSI EIA Standard 481-B 2001.
4. ams OSRAM packaging tape and reel conform to the requirements of EIA Standard 481-B.
5. In accordance with EIA standard device pin 1 is located next to the sprocket holes in the tape.
6. This drawing is subject to change without notice.

Soldering & Storage Information

The module has been tested and has demonstrated an ability to be reflow soldered to a PCB substrate. The solder reflow profile describes the expected maximum heat exposure of components during the solder reflow process of product on a PCB. Temperature is measured on top of component. The components should be limited to a maximum of three passes through this solder reflow profile.

Figure 65:
Solder Reflow Profile

Profile Feature Preheat/ Soak	Sn-Pb Eutectic Assembly	Pb-Free Assembly
Temperature Min (T_{smin})	100 °C	150 °C
Temperature Max (T_{smax})	150 °C	200 °C
Time (t_s) from (T_{smin} to T_{smax})	60-120 seconds	60-120 seconds
Ramp-up rate (T_L to T_p)	3 °C/second max.	3 °C/second max.
Liquidous temperature (T_L) Time (t_L) maintained above T_L	183 °C 60-150 seconds	217 °C 60-150 seconds
Peak package body temperature (T_p)	For users T_p must not exceed the classification temp. of 235 °C. For suppliers T_p must equal or exceed the classification temp. of 235 °C	For users T_p must not exceed the classification temp. of 260 °C. For suppliers T_p must equal or exceed the classification temp. of 260 °C
Time (t_p) ⁽¹⁾ within 5 °C of the specified classification temperature (T_c)	20 ⁽¹⁾ seconds	30 ⁽¹⁾ seconds
Ramp-down rate (T_p to T_L)	6 °C/second max.	6 °C/second max.
Time 25 °C to peak temperature	6 minutes max.	8 minutes max.

Note(s):

1. Tolerance for peak profile temperature (TP) is defined as a supplier minimum and a user maximum.

Figure 66:
Solder Reflow Profile Graph

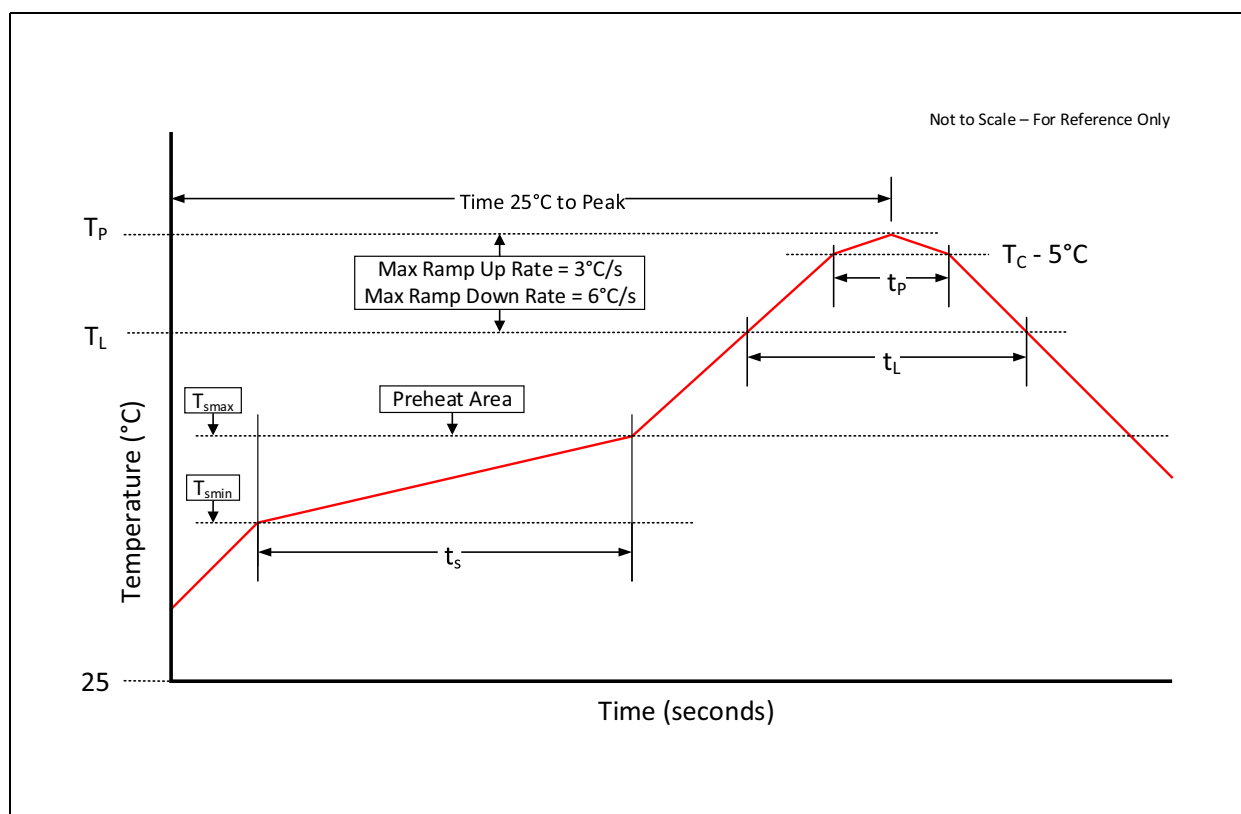

Storage Information

Moisture Sensitivity Optical characteristics of the device can be adversely affected during the soldering process by the release and vaporization of moisture that has been previously absorbed into the package. To ensure the package contains the smallest amount of absorbed moisture possible, each device is baked prior to being dry packed for shipping. Devices are dry packed in a sealed aluminized envelope called a moisture-barrier bag with silica gel to protect them from ambient moisture during shipping, handling, and storage before use.

Shelf Life

The calculated shelf life of the device in an unopened moisture barrier bag is 24 months from the date code on the bag when stored under the following conditions:

- Shelf Life: 24 months
- Ambient Temperature: <40°C
- Relative Humidity: <90%

Rebaking of the devices will be required if the devices exceed the 24 months shelf life or the Humidity Indicator Card shows that the devices were exposed to conditions beyond the allowable moisture region.

Floor Life

The module has been assigned a moisture sensitivity level of MSL 3. As a result, the floor life of devices removed from the moisture barrier bag is 168 hours from the time the bag was opened, provided that the devices are stored under the following conditions:

- Floor Life: 168 hours
- Ambient Temperature: <30°C
- Relative Humidity: <60%

If the floor life or the temperature/humidity conditions have been exceeded, the devices must be rebaked prior to solder reflow or dry packing.

Rebaking Instructions

When the shelf life or floor life limits have been exceeded, rebake at 50°C for 12 hours.

Laser Eye Safety

Complies with IEC/EN 60825-1:2014 and 21 CFR 1040.10 and 1040.11 except for deviations pursuant to Laser Notice No. 50, dated June 24, 2007

The TMD2755 is designed to meet the Class 1 laser safety limits including single faults in compliance with IEC/EN 60825-1:2014. In an end application system environment, the system may need to be tested to ensure it remains compliant. The system must not include any additional lens to concentrate the laser light or parameters set outside of the recommended operating conditions or any physical modification to the module during development could result in hazardous levels of radiation exposure.



Ordering & Contact Information

Figure 67:
Ordering Information

Ordering Code	I ² C Bus	I ² C Address	Delivery Form	Delivery Quantity
TMD27553	1.8V	0x39	Tape & Reel (13")	10000 pcs/reel
TMD27553M			Tape & Reel (7")	1000 pcs/reel

Buy our products or get free samples online at:

www.ams.com/Products

Technical Support is available at:

www.ams.com/Technical-Support

Provide feedback about this document at:

www.ams.com/Document-Feedback

For further information and requests, e-mail us at:

ams_sales@ams.com

For sales offices, distributors and representatives, please visit:

www.ams.com/Contact

Headquarters

ams-OSRAM AG

Tobelbader Strasse 30

8141 Premstaetten

Austria, Europe

Tel: +43 (0) 3136 500 0

Website: www.ams.com

RoHS Compliant & ams Green Statement

RoHS: The term RoHS compliant means that ams-OSRAM AG products fully comply with current RoHS directives. Our semiconductor products do not contain any chemicals for all 6 substance categories plus additional 4 substance categories (per amendment EU 2015/863), including the requirement that lead not exceed 0.1% by weight in homogeneous materials. Where designed to be soldered at high temperatures, RoHS compliant products are suitable for use in specified lead-free processes.

ams Green (RoHS compliant and no Sb/Br/Cl): ams Green defines that in addition to RoHS compliance, our products are free of Bromine (Br) and Antimony (Sb) based flame retardants (Br or Sb do not exceed 0.1% by weight in homogeneous material) and do not contain Chlorine (Cl not exceed 0.1% by weight in homogeneous material).

Important Information: The information provided in this statement represents ams-OSRAM AG knowledge and belief as of the date that it is provided. ams-OSRAM AG bases its knowledge and belief on information provided by third parties, and makes no representation or warranty as to the accuracy of such information. Efforts are underway to better integrate information from third parties. ams-OSRAM AG has taken and continues to take reasonable steps to provide representative and accurate information but may not have conducted destructive testing or chemical analysis on incoming materials and chemicals. ams-OSRAM AG and ams-OSRAM AG suppliers consider certain information to be proprietary, and thus CAS numbers and other limited information may not be available for release.

Copyrights & Disclaimer

Copyright ams-OSRAM AG, Tobelbader Strasse 30, 8141 Premstaetten, Austria-Europe. Trademarks Registered. All rights reserved. The material herein may not be reproduced, adapted, merged, translated, stored, or used without the prior written consent of the copyright owner.

Devices sold by ams-OSRAM AG are covered by the warranty and patent indemnification provisions appearing in its General Terms of Trade. ams-OSRAM AG makes no warranty, express, statutory, implied, or by description regarding the information set forth herein. ams-OSRAM AG reserves the right to change specifications and prices at any time and without notice. Therefore, prior to designing this product into a system, it is necessary to check with ams-OSRAM AG for current information. This product is intended for use in commercial applications. Applications requiring extended temperature range, unusual environmental requirements, or high reliability applications, such as military, medical life-support or life-sustaining equipment are specifically not recommended without additional processing by ams-OSRAM AG for each application. This product is provided by ams-OSRAM AG "AS IS" and any express or implied warranties, including, but not limited to the implied warranties of merchantability and fitness for a particular purpose are disclaimed.

ams-OSRAM AG shall not be liable to recipient or any third party for any damages, including but not limited to personal injury, property damage, loss of profits, loss of use, interruption of business or indirect, special, incidental or consequential damages, of any kind, in connection with or arising out of the furnishing, performance or use of the technical data herein. No obligation or liability to recipient or any third party shall arise or flow out of ams-OSRAM AG rendering of technical or other services.

Document Status

Document Status	Product Status	Definition
Product Preview	Pre-Development	Information in this datasheet is based on product ideas in the planning phase of development. All specifications are design goals without any warranty and are subject to change without notice
Preliminary Datasheet	Pre-Production	Information in this datasheet is based on products in the design, validation or qualification phase of development. The performance and parameters shown in this document are preliminary without any warranty and are subject to change without notice
Datasheet	Production	Information in this datasheet is based on products in ramp-up to full production or full production which conform to specifications in accordance with the terms of ams-OSRAM AG standard warranty as given in the General Terms of Trade
Datasheet (discontinued)	Discontinued	Information in this datasheet is based on products which conform to specifications in accordance with the terms of ams-OSRAM AG standard warranty as given in the General Terms of Trade, but these products have been superseded and should not be used for new designs

Revision Information

Changes from 2-00 (2021-Sep-10) to current revision 3-00 (2023-Jan-02)	Page
Updated "Shelf Life" to 24 months	45

Note(s):

1. Page and figure numbers for the previous version may differ from page and figure numbers in the current revision.
2. Correction of typographical errors is not explicitly mentioned.

Content Guide

- 1 General Description**
 - 1 Key Benefits & Features
 - 2 Applications
 - 2 Block Diagram
- 3 Pin Assignments**
- 4 Absolute Maximum Ratings**
- 5 Electrical Characteristics**
- 8 Typical Operating Characteristics**
- 10 Detailed Description**
 - 10 Proximity
 - 10 Ambient Light Sensing, ALS
 - 11 Operational State Diagram
 - 12 I²C Characteristics
 - 12 I²C Write Transaction
 - 12 I²C Read Transaction
 - 13 Timing Diagrams
- 14 Register Description**
 - 16 Detailed Register Description
 - 16 Enable Register (Address 0x80)
 - 17 ATIME Register (Address 0x81)
 - 17 PRATE Register (Address 0x82)
 - 18 AWTIME Register (Address 0x83)
 - 18 AILTL Register (Address 0x84)
 - 18 AILTH Register (Address 0x85)
 - 19 AIHTL Register (Address 0x86)
 - 19 AIHTH Register (Address 0x87)
 - 20 PILTL Register (Address 0x88)
 - 20 PILTH Register (Address 0x89)
 - 21 PIHTL Register (Address 0x8A)
 - 21 PIHTH Register (Address 0x8B)
 - 22 PERS Register (Address 0x8C)
 - 23 CFG0 Register (Address 0x8D)
 - 23 PCFG0 Register (Address 0x8E)
 - 25 PCFG1 Register (Address 0x8F)
 - 25 PCFG2 Register (Address 0x90)
 - 26 CFG1 Register (Address 0x91)
 - 26 REVID Register (Address 0x92)
 - 27 ID Register (Address 0x93)
 - 27 STATUS Register (Address 0x94)
 - 28 ALSL Register (Address 0x95)
 - 28 ALSH Register (Address 0x96)
 - 28 IRL Register (Address 0x97)
 - 28 IRH Register (Address 0x98)
 - 29 PDATAL Register (Address 0x99)
 - 29 PDATAH Register (Address 0x9A)
 - 30 REVID2 Register (Address 0xA6)
 - 30 SOFTRST Register (Address 0xA8)
 - 31 PWTIME Register (Address 0xA9)
 - 31 CFG8 Register (Address 0xAA)
 - 32 CFG3 Register (Address 0xAB)
 - 32 CFG6 Register (Address 0xAE)

33	POFFSETL Register (Address 0xC0)
33	POFFSETH Register (Address 0xC1)
34	CALIB Register (Address 0xD7)
35	CALIB_OFFSET Register (Address 0xD8)
36	CALIBCFG Register (Address 0xD9)
37	CALIBSTAT Register (Address 0xDC)
37	INTENAB Register (Address 0xDD)
38	FAC_L Register (Address 0xE6)
38	FAC_H Register (Address 0xE7)
38	TEST9 Register (Address 0xF9)
39	Application Information
39	Schematic (preliminary)
40	Recommended Circuit Layout
41	Package Drawings & Markings
42	Recommended PCB Pad Layout
43	Tape & Reel Information
44	Soldering & Storage Information
45	Storage Information
45	Shelf Life
46	Floor Life
46	Rebaking Instructions
46	Laser Eye Safety
47	Ordering & Contact Information
48	RoHS Compliant & ams Green Statement
49	Copyrights & Disclaimer
50	Document Status
51	Revision Information