



TAOGLAS®



Datasheet

LTE Wideband Terminal Mount Monopole Antenna

Part No:
TG.42.0112

Description

LTE Wideband Terminal Mount Monopole Antenna

Features:

- Small Form Factor Enclosure
- LTE 600-3000MHz
- SMA Male Right Angle Connector
- Perfect for 4G routers
- Dimensions: 62.5 x 17.5 x 8 mm
- RoHS & Reach Compliant

1. Introduction	3
2. Specifications	4
3. Antenna Characteristics	6
4. Radiation Patterns	9
5. Mechanical Drawing	19
6. Packaging	20
<hr/>	
Changelog	21

Taoglas makes no warranties based on the accuracy or completeness of the contents of this document and reserves the right to make changes to specifications and product descriptions at any time without notice. Taoglas reserves all rights to this document and the information contained herein. Reproduction, use or disclosure to third parties without express permission is strictly prohibited.



1. Introduction



The Taoglas TG.42.0112 is a small terminal mount antenna designed to be directly mounted onto devices using the SMA Male right angle connector at the base of the enclosure. The TG.42 has been expertly designed to cover all major worldwide 4G LTE bands in a miniature form factor, with high efficiency and optimum peak gain.

The TG.42.0112 weighs just 8g so it is perfect for applications that may be weight sensitive such as UAVs and robotics. With the capability to cover Band 71, the TG.42 is one of the smallest wide bandwidth(600-3000MHz) terminal antennas on the market.

Typical Applications Include:

- Gateways and Routers
- Remote Monitoring
- Industrial IoT
- Smart Meters

For further information please contact your regional Taoglas customer support team.

2. Specifications

Electrical								
Band	Frequency (MHz)	Efficiency (%)	Average Gain (dB)	Peak Gain (dBi)	Impedance	Polarization	Radiation Pattern	Max. input power
5G NR B71	617~698	62.9	-2.01	2.10	50Ω	Linear	Omni	5W
LTE 700	698~824	84.6	--0.73	3.30				
GSM 800/900	824~960	78.9	-1.03	3.29				
DCS	1710~1880	82.5	-0.83	3.56				
PCS	1850~1990	81.8	-0.87	3.60				
UMTS1	1920~2170	82.6	-0.83	3.60				
LTE2600	2300~2690	68.2	-1.66	3.62				
Mechanical								
Dimensions		62.2x 17 x 7.8 mm						
Weight		8 g						
Connector		SMA (M)RA						
Environmental								
Temperature Range		-40°C to 85°C						

*Tested on a 150x90mm Groundplane

5G/4G Bands			
Band Number	5G NR / FR1 / LTE / LTE-Advanced / WCDMA / HSPA / HSPA+ / TD-SCDMA		
	Uplink	Downlink	Covered
1	UL: 1920 to 1980	DL: 2110 to 2170	✓
2	UL: 1850 to 1910	DL: 1930 to 1990	✓
3	UL: 1710 to 1785	DL: 1805 to 1880	✓
4	UL: 1710 to 1755	DL: 2110 to 2155	✓
5	UL: 824 to 849	DL: 869 to 894	✓
7	UL: 2500 to 2570	DL: 2620 to 2690	✓
8	UL: 880 to 915	DL: 925 to 960	✓
9	UL: 1749.9 to 1784.9	DL: 1844.9 to 1879.9	✓
11	UL: 1427.9 to 1447.9	DL: 1475.9 to 1495.9	✗
12	UL: 699 to 716	DL: 729 to 746	✓
13	UL: 777 to 787	DL: 746 to 756	✓
14	UL: 788 to 798	DL: 758 to 768	✓
17	UL: 704 to 716	DL: 734 to 746	✓
18	UL: 815 to 830	DL: 860 to 875	✓
19	UL: 830 to 845	DL: 875 to 890	✓
20	UL: 832 to 862	DL: 791 to 821	✓
21	UL: 1447.9 to 1462.9	DL: 1495.9 to 1510.9	✓
22	UL: 3410 to 3490	DL: 3510 to 3590	✗
23	UL: 2000 to 2020	DL: 2180 to 2200	✓
24	UL: 1625.5 to 1660.5	DL: 1525 to 1559	✓
25	UL: 1850 to 1915	DL: 1930 to 1995	✓
26	UL: 814 to 849	DL: 859 to 894	✓
27	UL: 807 to 824	DL: 852 to 869	✓
28	UL: 703 to 748	DL: 758 to 803	✓
29	UL: -	DL: 717 to 728	✓
30	UL: 2305 to 2315	DL: 2350 to 2360	✓
31	UL: 452.5 to 457.5	DL: 462.5 to 467.5	✗
32	UL: -	DL: 1452 - 1496	✗
35		1850 to 1910	✓
38		2570 to 2620	✓
39		1880 to 1920	✓
40		2300 to 2400	✓
41		2496 to 2690	✓
42		3400 to 3600	✗
43		3600 to 3800	✗
48		3550 to 3700	✗
66	UL: 1710-1780	DL: 2110-2200	✓
71		617 to 698	✓
74/75/76		1427 to 1518	✗
78		3300 to 3800	✗
79		4400 to 5000	✗
85	698-716	728-746	✓

3. Antenna Characteristics

3.1 Return Loss

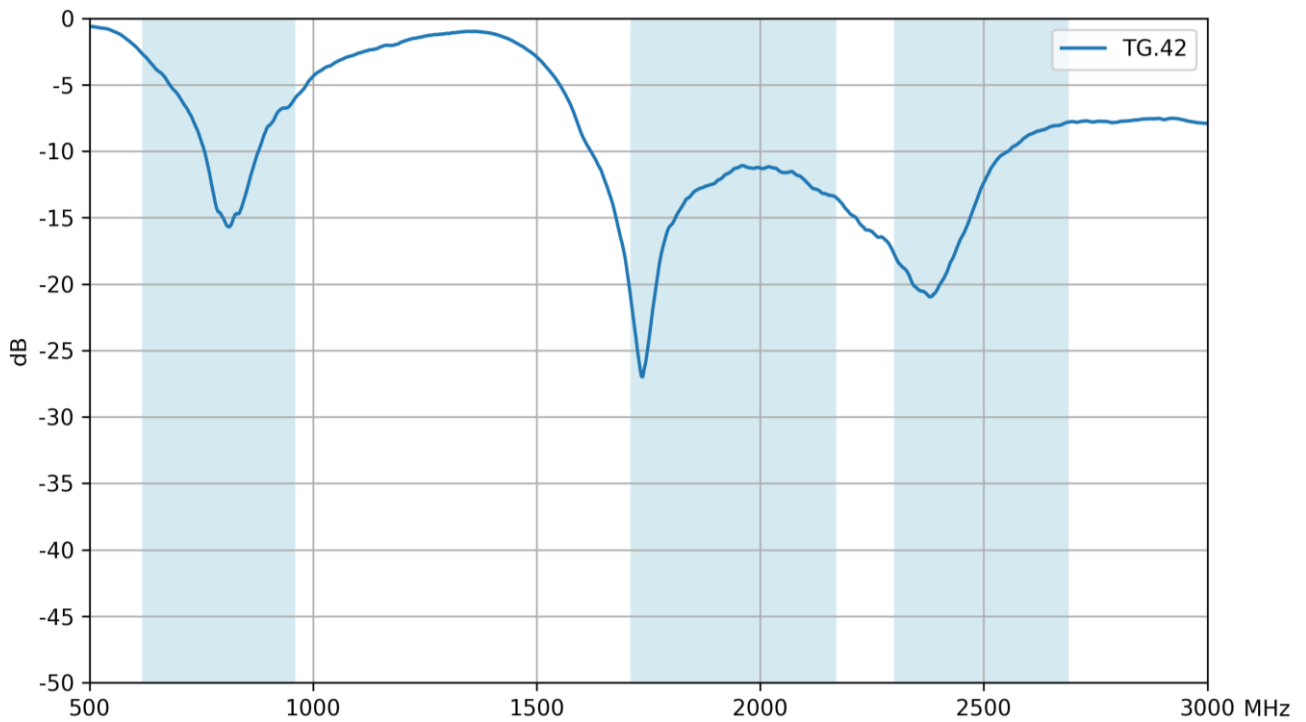

3.2 Efficiency

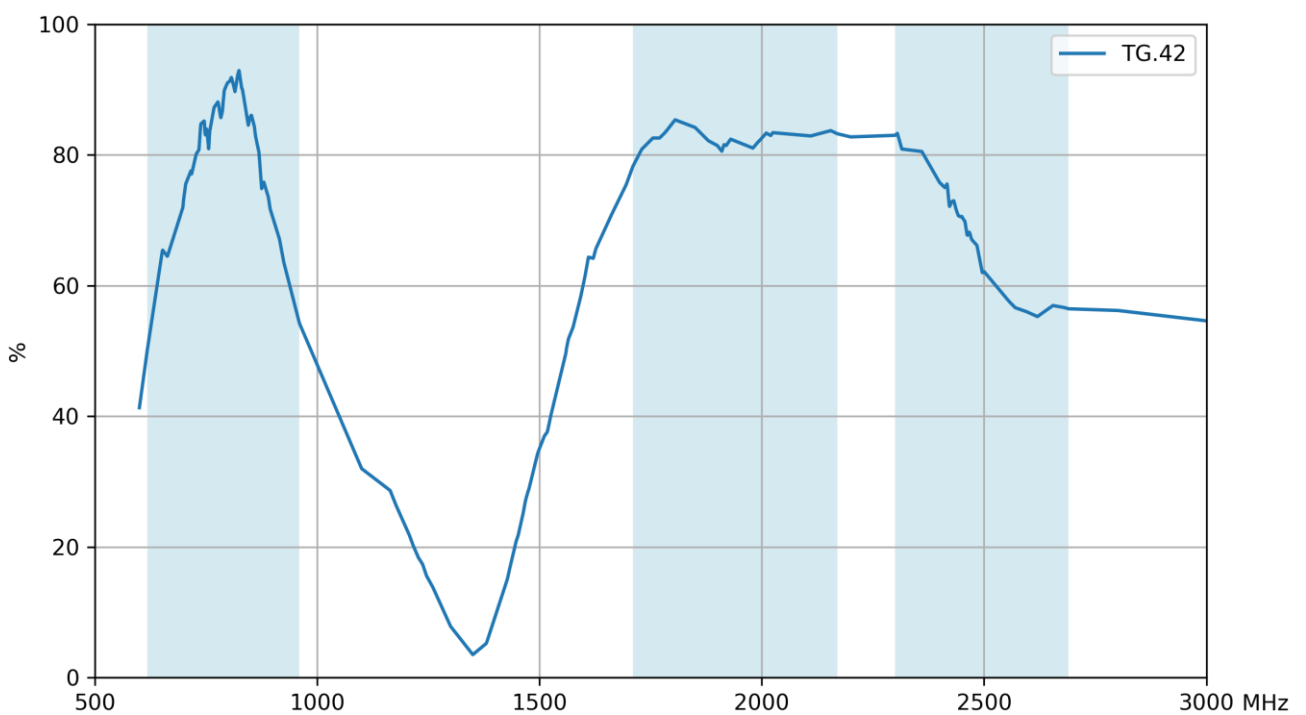

3.3 Average Gain

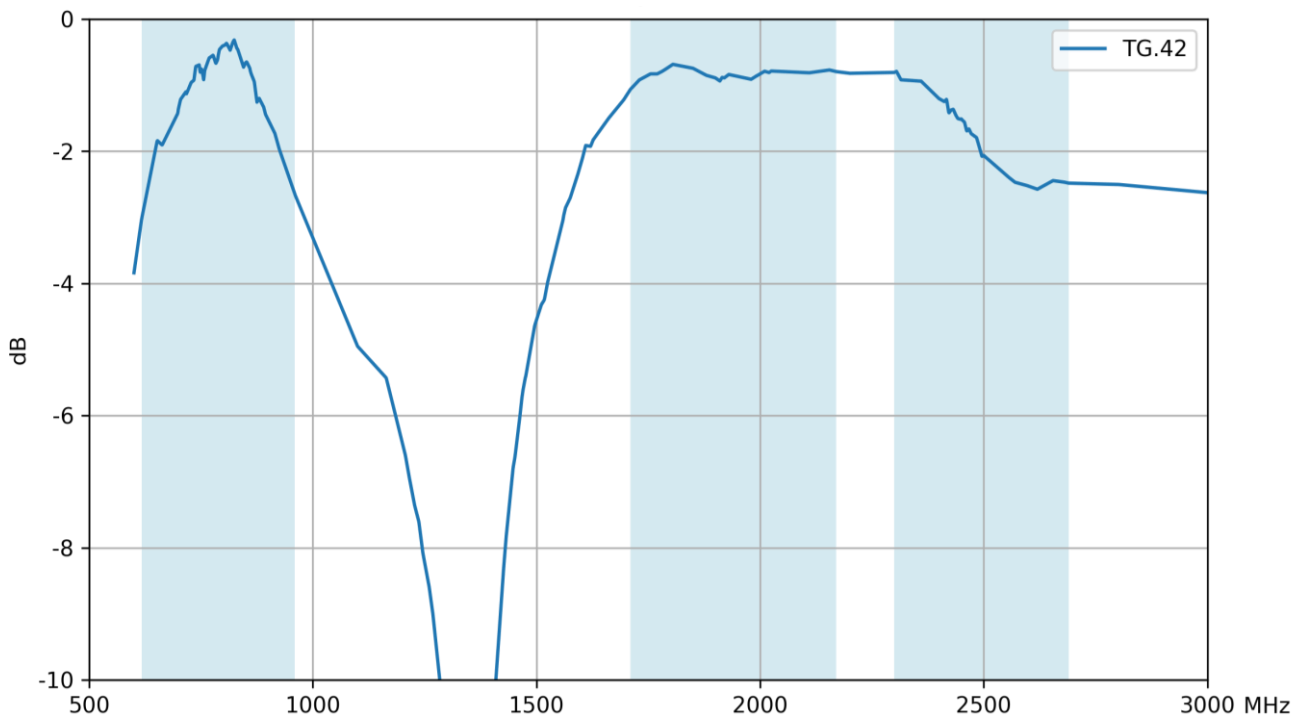

3.4 Peak Gain

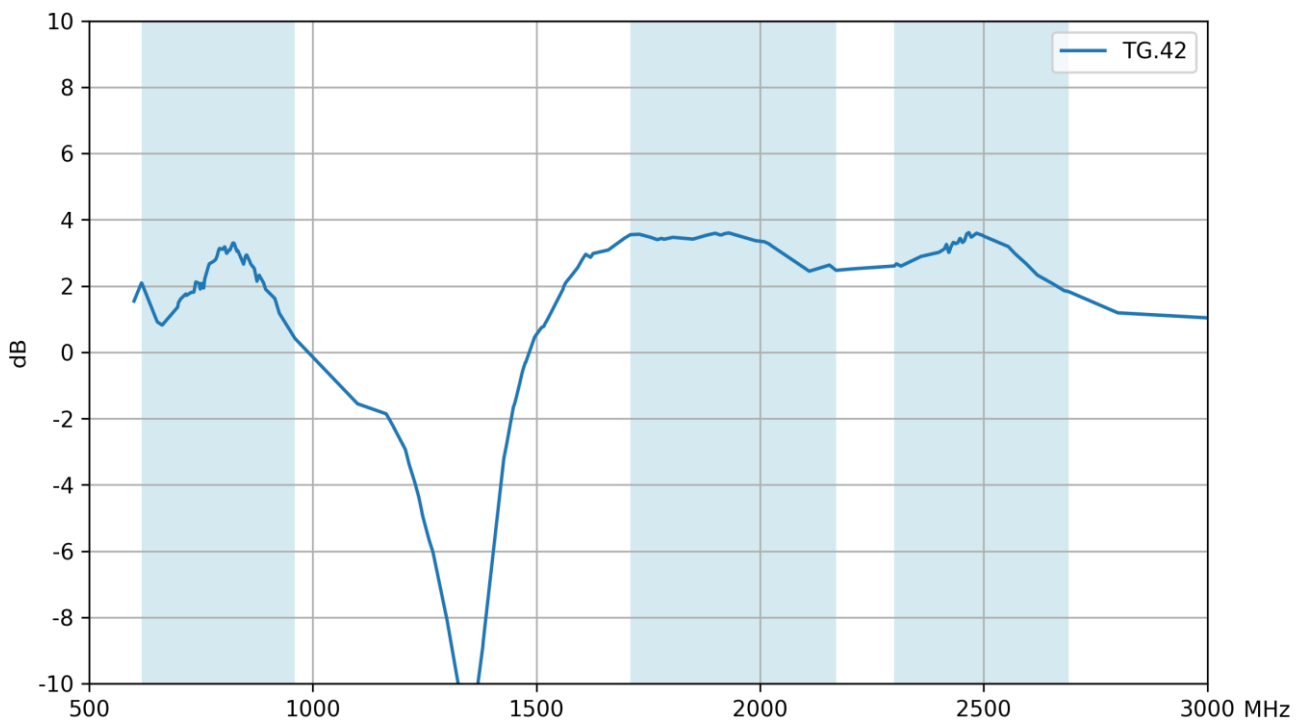

4. Radiation Patterns

4.1 Test Seup

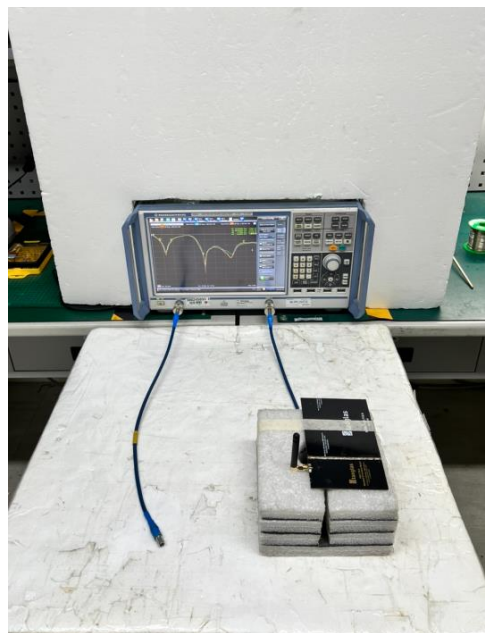
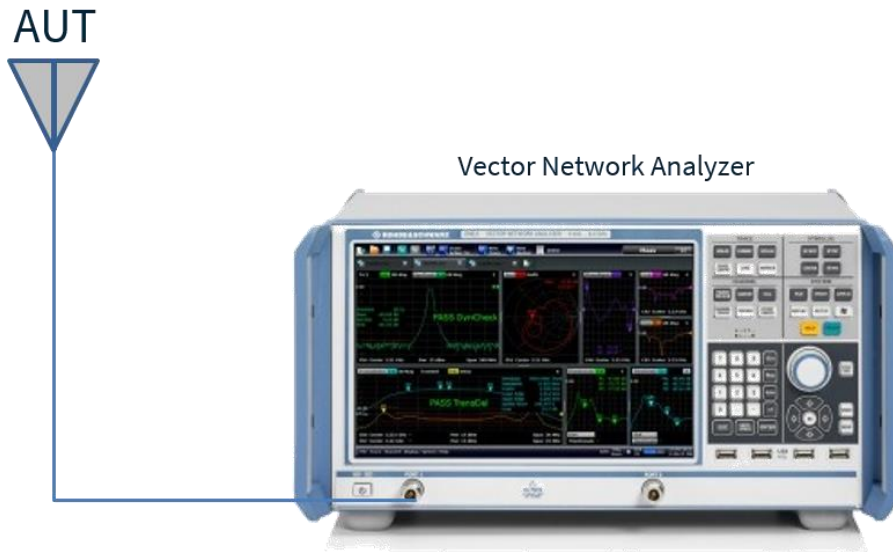

4.2 Radiation Performance

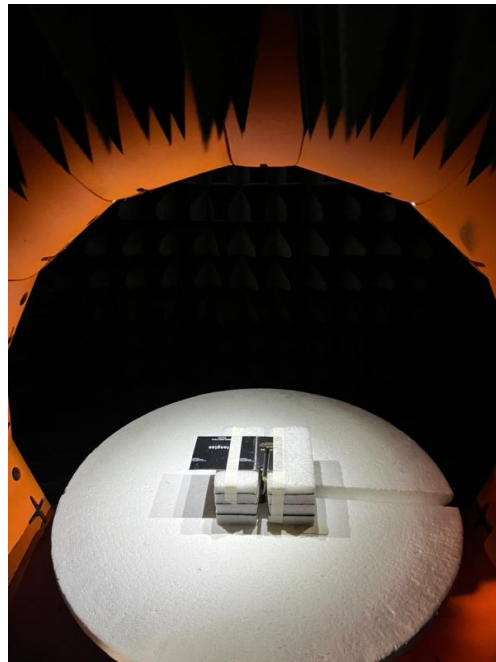
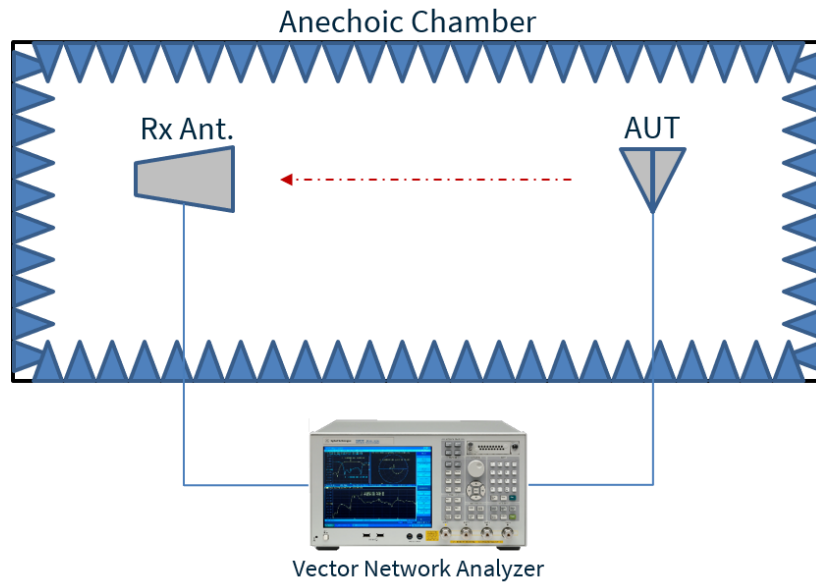

4.3 663MHz _2D & 3D Radiation Patterns

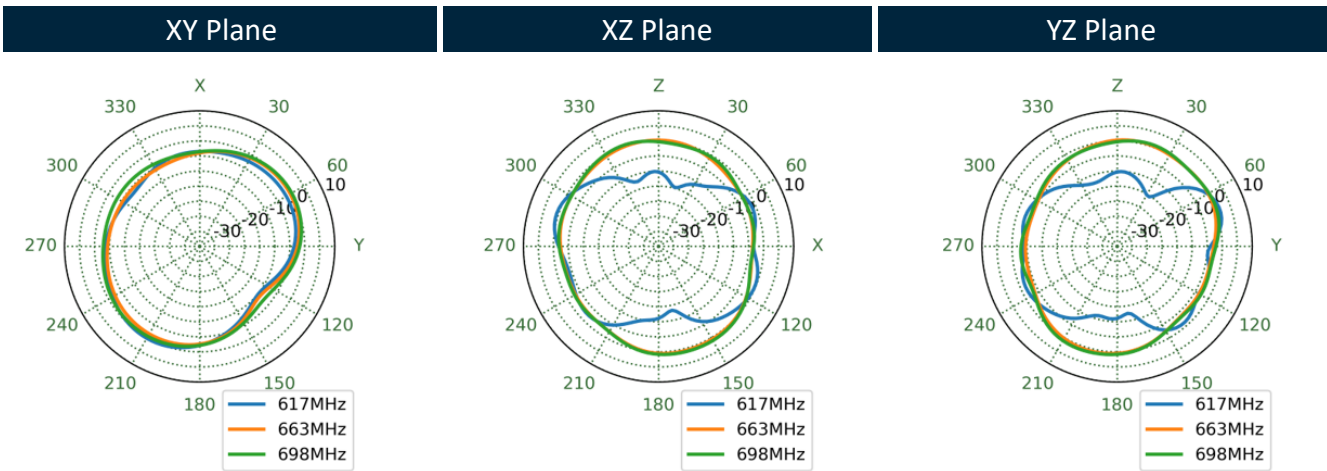
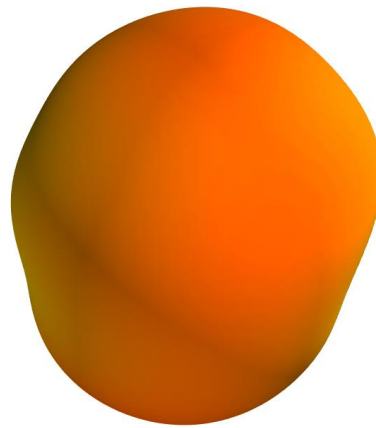

751MHz

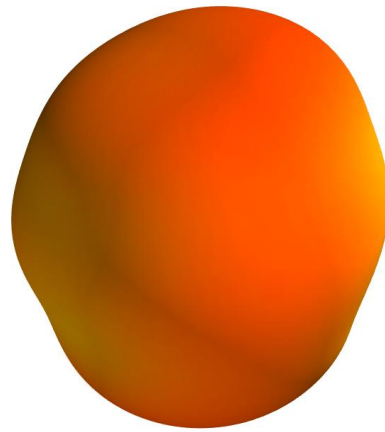

XY Plane

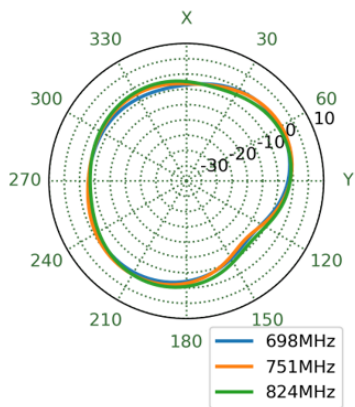

XZ Plane

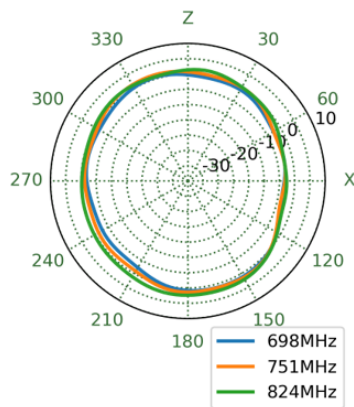

YZ Plane

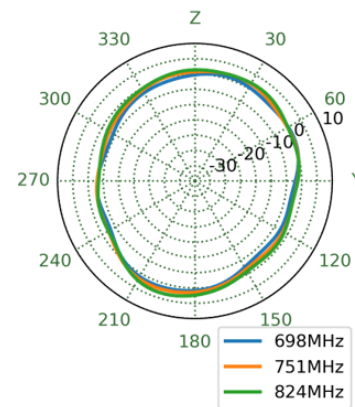

880MHz

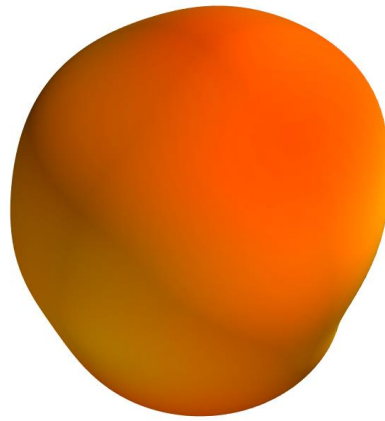

XY Plane

XZ Plane

YZ Plane

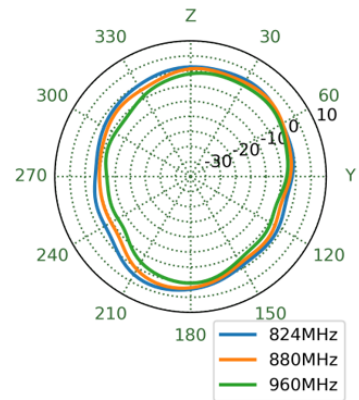
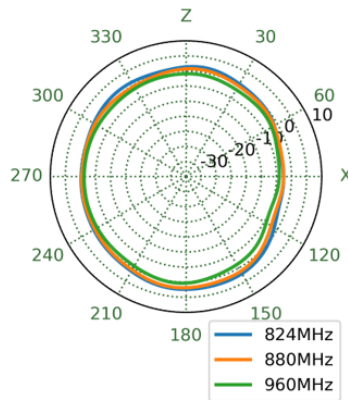
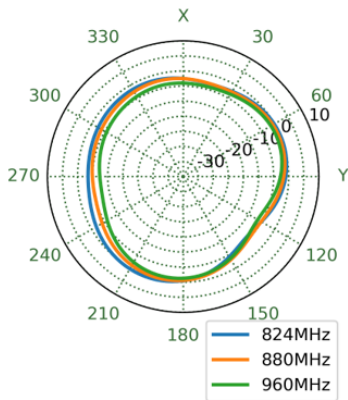

1805MHz

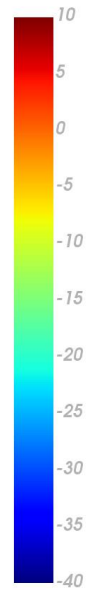
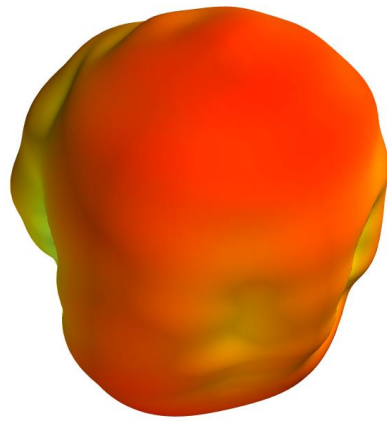

XY Plane

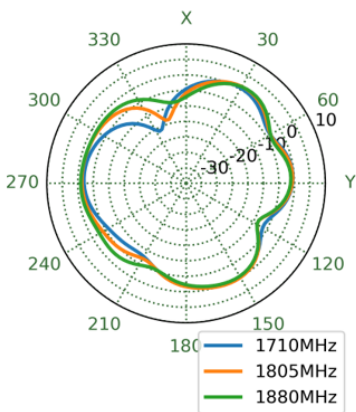

XZ Plane

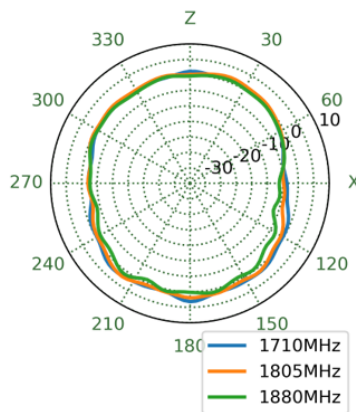

YZ Plane

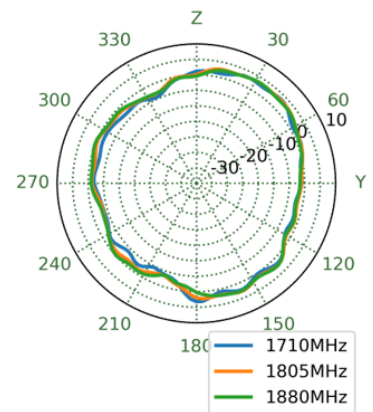

1920MHz

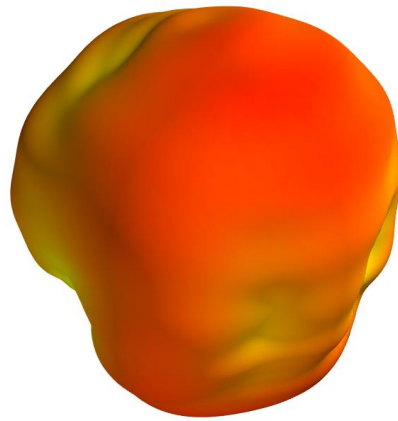

XY Plane

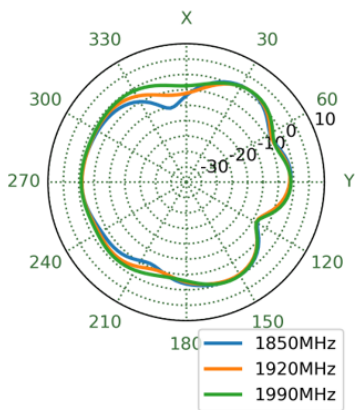

XZ Plane

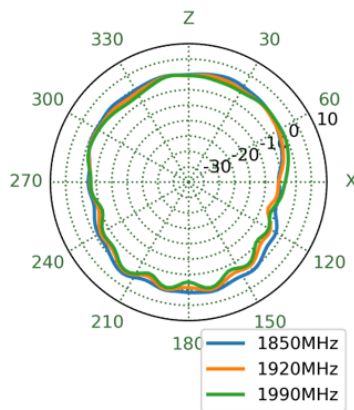

YZ Plane

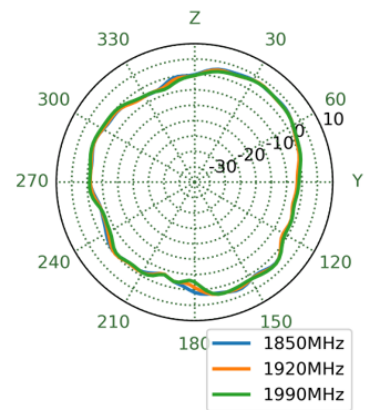

2010MHz

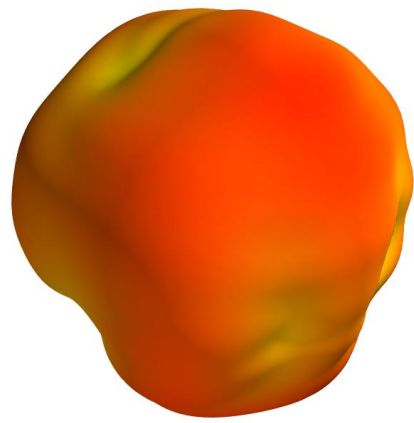

XY Plane

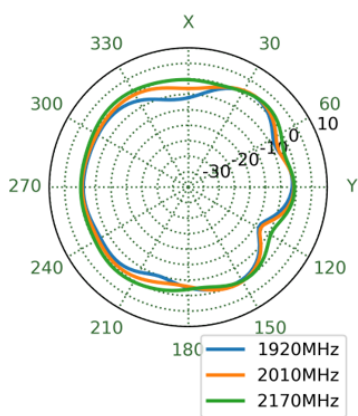

XZ Plane

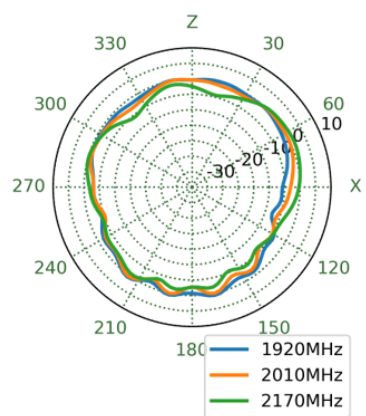

YZ Plane

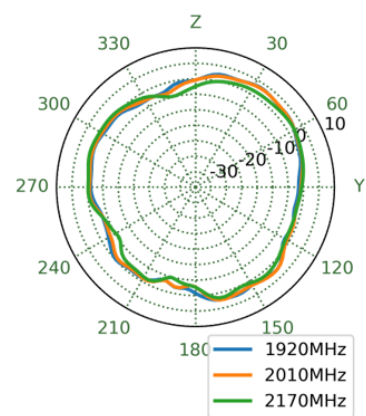

2500MHz

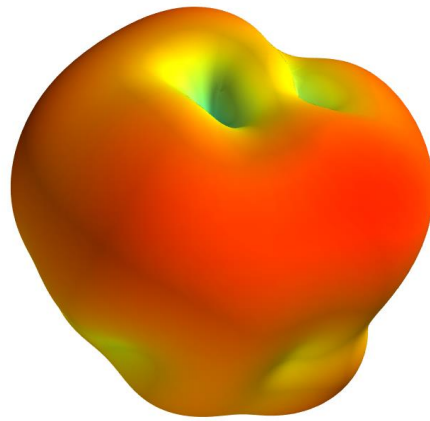

XY Plane

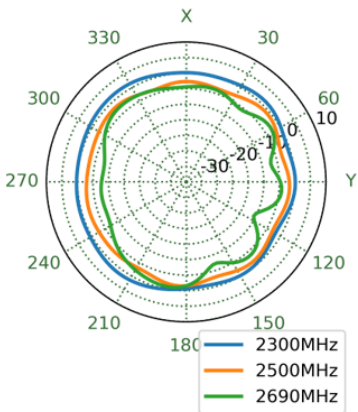

XZ Plane

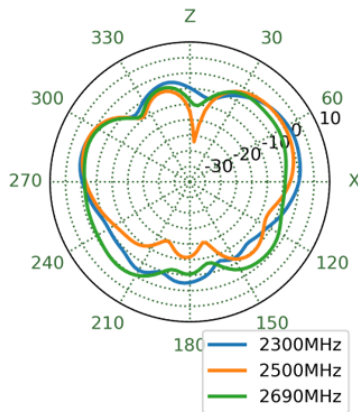

YZ Plane

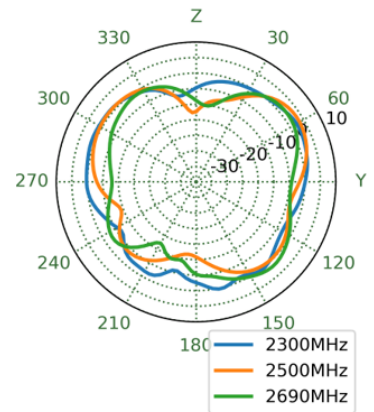

5. Mechanical Drawing (Units: mm)

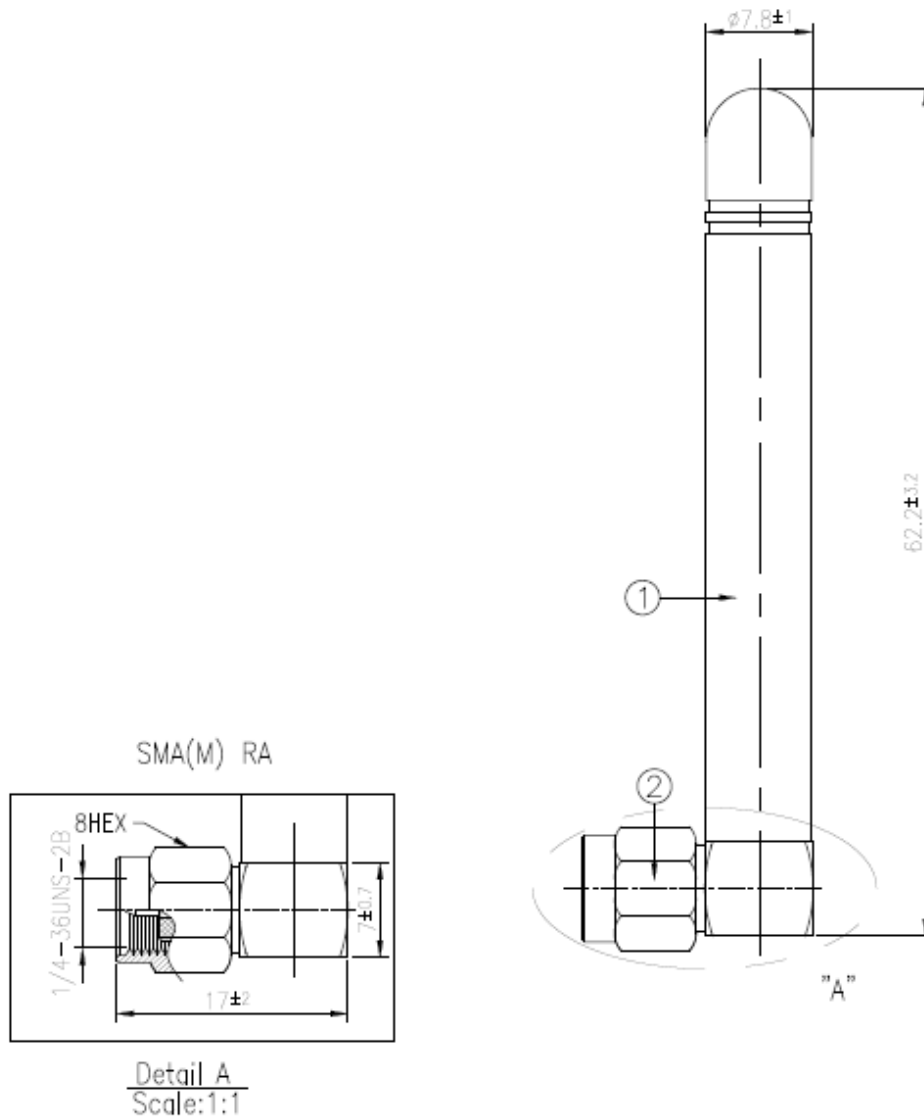

	Name	Material	Finish	QTY
1	Antenna Housing	TPEE	Black	1
2	SMA(M)RA	Brass	Au Plated	1

6. Packaging



1 PCS / Zipper Bag



100 PCS / PE bag

SPQ Label

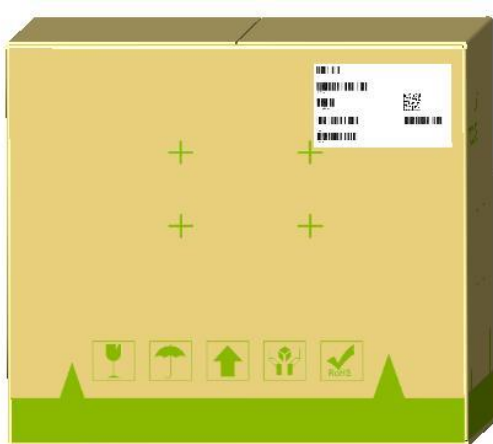

1200 PCS / Carton

Carton(mm): 360x310x160

Carton Label

Changelog for the datasheet

SPE-22-8-137 -TG.42

Revision: B (Current Version)	
Date:	2023-07-07
Notes:	Updated mechanical specifications
Author:	Cesar Sousa

Previous Revisions

Revision: A (Original First Release)	
Date:	2022-08-17
Notes:	Initial Release
Author:	Gary West



www.taoglas.com