

BU-1420701873 (Jack Assembly End Launch SMA)

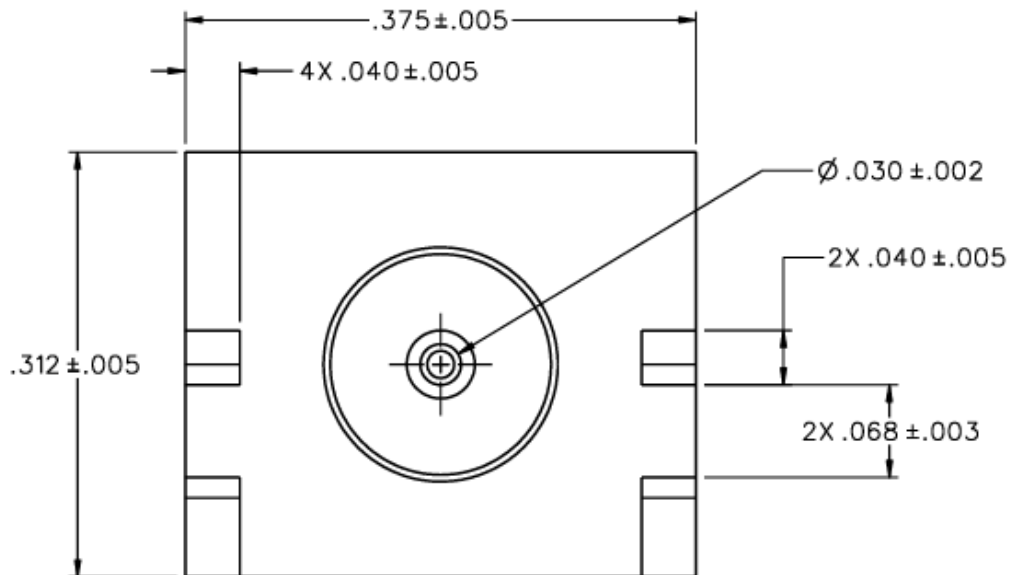

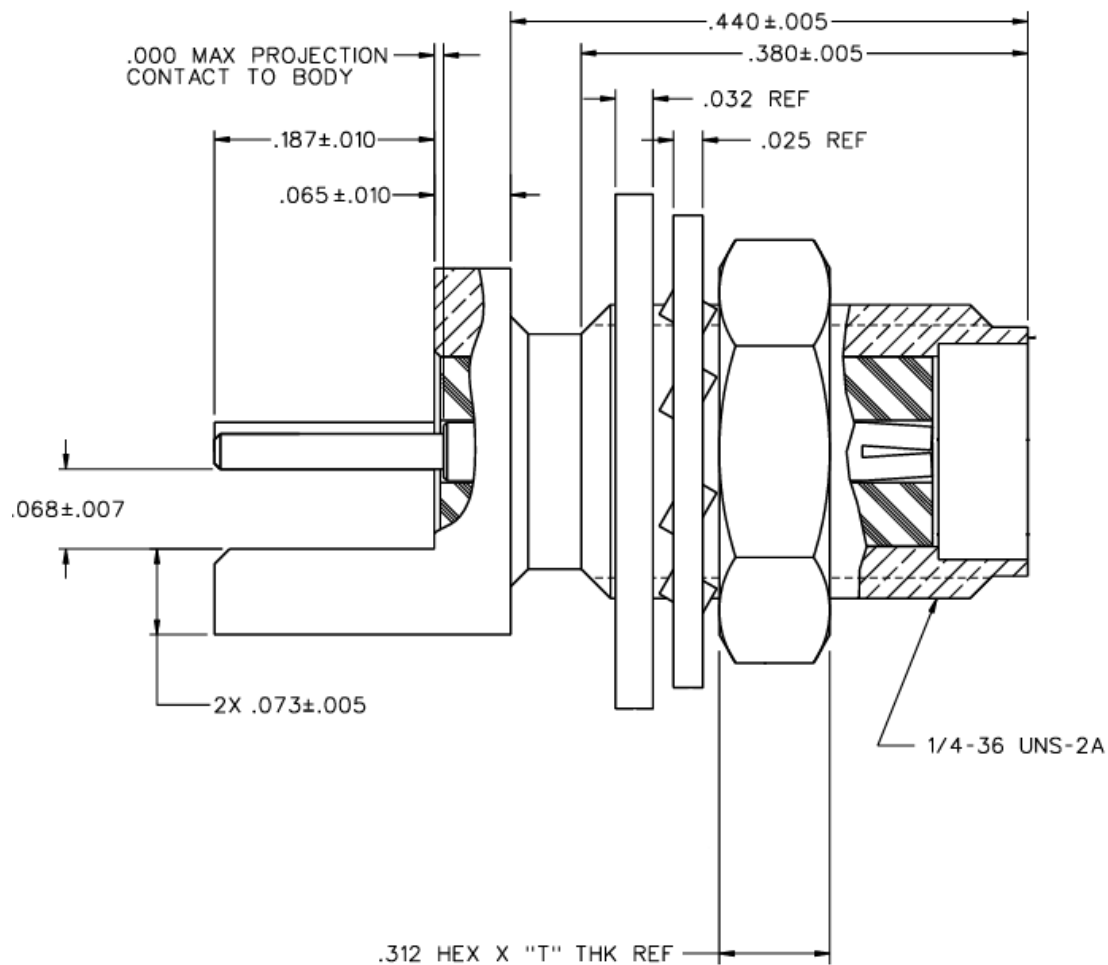

(Dimensions in Inches)

- Low VSWR Board edge, end launch mounting
- Designed to mount on .062" (1.57mm) Circuit Boards.
- Impedance: 50 Ω
- Insulation Resistance: 5000 MΩ
- Frequency: DC to 18 GHz.
- Working Voltage: 335 VRMS Max
- Dielectric Withstand: 1000 VRMS
- Contact Resistance: 3 milliohms
- Insertion Loss: .15 dB Maximum
- Mating Cycles: 500 Minimum
- Meets or exceeds the applicable paragraph of MIL-PRF-39012
- Operating Temperature: -65°C to 165°C
- RoHS 3 Compliant