

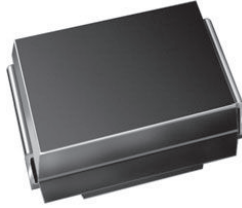

### Surface-Mount PAR<sup>®</sup> Transient Voltage Suppressors

High Temperature Stability and High Reliability Conditions



SMB (DO-214AA)



PRIMARY CHARACTERISTICS	
V <sub>BR</sub>	12 V to 51 V
V <sub>WM</sub>	10.2 V to 43.6 V
P <sub>PPM</sub>	1500 W
T <sub>J</sub> max.	185 °C
Polarity	Unidirectional
Package	SMB (DO-214AA)

#### TYPICAL APPLICATIONS

Use in sensitive electronics protection against voltage transients induced by inductive load switching and lightning on ICs, MOSFET, signal lines of sensor units for automotive.

#### FEATURES

- Junction passivation optimized design passivated anisotropic rectifier technology
- T<sub>J</sub> = 185 °C capability suitable for high reliability and automotive requirement
- 1500 W peak pulse power capability with a 10/1000 µs waveform
- Unidirectional
- Excellent clamping capability
- Very fast response time
- Meets MSL level 1, per J-STD-020, LF maximum peak of 260 °C
- AEC-Q101 qualified
- Material categorization: for definitions of compliance please see [www.vishay.com/doc?99912](http://www.vishay.com/doc?99912)



#### MECHANICAL DATA

**Case:** SMB (DO-214AA)

Molding compound meets UL 94 V-0 flammability rating

Base P/NHM3 - halogen-free, RoHS-compliant, and AEC-Q101 qualified

**Terminals:** matte tin plated leads, solderable per J-STD-002 and JESD 22-B102

HM3 suffix meets JESD 201 class 2 whisker test

**Polarity:** color band denotes cathode end

MAXIMUM RATINGS (T <sub>A</sub> = 25 °C, unless otherwise noted)			
PARAMETER	SYMBOL	VALUE	UNIT
Peak pulse power dissipation with a 10/1000 µs waveform (fig.1) <sup>(1)</sup>	P <sub>PPM</sub>	1500	W
Peak pulse current with a 10/1000 µs waveform (fig.3) <sup>(1)</sup>	I <sub>PPM</sub>	See table next page	A
Operating junction and storage temperature range	T <sub>J</sub> , T <sub>STG</sub>	-65 to +185	°C

#### Note

<sup>(1)</sup> Non-repetitive current pulse, per fig.3 and derated above T<sub>A</sub> = 25 °C per fig.2



ELECTRICAL CHARACTERISTICS (T <sub>A</sub> = 25 °C, unless otherwise noted)											
DEVICE TYPE	DEVICE MARKING CODE	BREAKDOWN VOLTAGE V <sub>BR</sub> <sup>(1)</sup> AT I <sub>T</sub> (V)			TEST CURRENT I <sub>T</sub> (mA)	STAND-OFF VOLTAGE V <sub>WM</sub> (V)	MAXIMUM REVERSE LEAKAGE AT V <sub>WM</sub> I <sub>R</sub> (μA)	MAXIMUM REVERSE LEAKAGE AT V <sub>WM</sub> I <sub>D</sub> (μA) T <sub>J</sub> = 150 °C	MAXIMUM PEAK PULSE SURGE CURRENT I <sub>PPM</sub> (A)	MAXIMUM CLAMPING VOLTAGE AT I <sub>PPM</sub> V <sub>C</sub> (V)	TYPICAL TEMP. COEFFICIENT OF V <sub>BR</sub> <sup>(2)</sup> α <sub>T</sub> (%/°C)
		MIN.	NOM.	MAX.							
T15B12A	KX5	11.4	12.0	12.6	1.0	10.2	2.0	12.0	91.2	17.0	0.070
T15B13A	KZ5	12.4	13.0	13.7	1.0	11.1	2.0	10.0	83.8	18.5	0.072
T15B15A	LG5	14.3	15.0	15.8	1.0	12.8	1.0	10.0	73.1	21.2	0.076
T15B16A	LK5	15.2	16.0	16.8	1.0	13.6	1.0	10.0	68.9	22.5	0.078
T15B18A	LM5	17.1	18.0	18.9	1.0	15.3	1.0	10.0	60.8	25.5	0.080
T15B20A	LR5	19.0	20.0	21.0	1.0	17.1	1.0	10.0	56.0	27.7	0.082
T15B22A	LS5	20.9	22.0	23.1	1.0	18.8	1.0	10.0	50.7	30.6	0.084
T15B24A	LV5	22.8	24.0	25.2	1.0	20.5	1.0	10.0	46.7	33.2	0.085
T15B27A	LW5	25.7	27.0	28.4	1.0	23.1	1.0	10.0	41.3	37.5	0.087
T15B30A	ME5	28.5	30.0	31.5	1.0	25.6	1.0	10.0	37.4	41.4	0.088
T15B33A	MG5	31.4	33.0	34.7	1.0	28.2	1.0	10.0	33.9	45.7	0.089
T15B36A	MJ5	34.2	36.0	37.8	1.0	30.8	1.0	15.0	31.1	49.9	0.090
T15B39A	MM5	37.1	39.0	41.0	1.0	33.3	1.0	15.0	28.8	53.9	0.091
T15B43A	MN5	40.9	43.0	45.2	1.0	36.8	1.0	20.0	26.1	59.3	0.092
T15B47A	MR5	44.7	47.0	49.4	1.0	40.2	1.0	20.0	23.9	64.8	0.092
T15B51A	MT5	48.5	51.0	53.6	1.0	43.6	1.0	20.0	22.1	70.1	0.093

**Notes**

- (1) V<sub>BR</sub> measured after I<sub>T</sub> applied for 300 μs, I<sub>T</sub> = square wave pulse or equivalent
- (2) To calculate V<sub>BR</sub> vs. junction temperature, use the following formula: V<sub>BR</sub> at T<sub>J</sub> = V<sub>BR</sub> at 25 °C x (1 + α<sub>T</sub> x (T<sub>J</sub> - 25))
- (3) All terms and symbols are consistent with ANSI/IEEE C62.35

IMMUNITY TO STATIC ELECTRICAL DISCHARGE TO THE FOLLOWING STANDARDS (T <sub>A</sub> = 25 °C unless otherwise noted)				
STANDARD	TEST TYPE	TEST CONDITIONS	SYMBOL	VALUE
IEC 61000-4-2	Contact discharge	C = 150 pF, R = 330 Ω	ESD	30 kV
	Air discharge			30 kV

ORDERING INFORMATION (Example)				
PREFERRED P/N	UNIT WEIGHT (g)	PREFERRED PACKAGE CODE	BASE QUANTITY	DELIVERY MODE
T15B12AHM3/H <sup>(1)</sup>	0.107	H	750	7" diameter plastic tape and reel
T15B12AHM3/I <sup>(1)</sup>	0.107	I	3200	13" diameter plastic tape and reel

**Note**

- (1) AEC-Q101 qualified

## RATINGS AND CHARACTERISTICS CURVES ( $T_A = 25\text{ }^\circ\text{C}$ , unless otherwise noted)

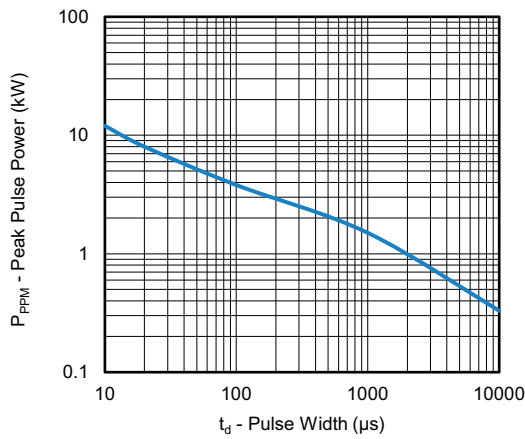

Fig. 1 - Peak Pulse Power Rating Curve

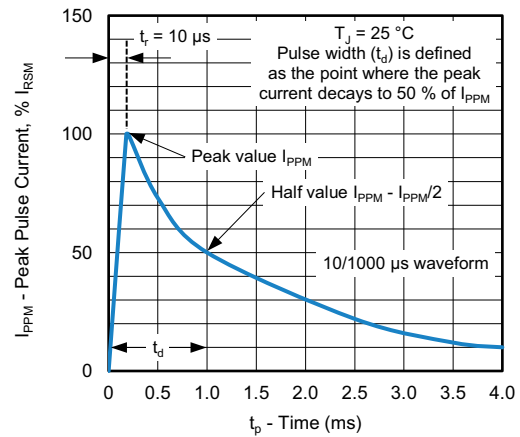

Fig. 3 - Pulse Waveform

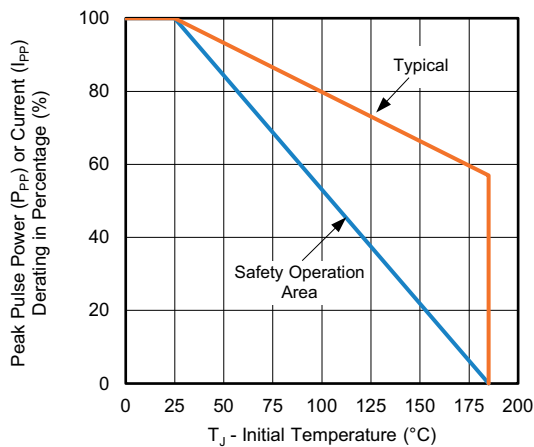

Fig. 2 - Pulse Power or Current vs. Initial Junction Temperature

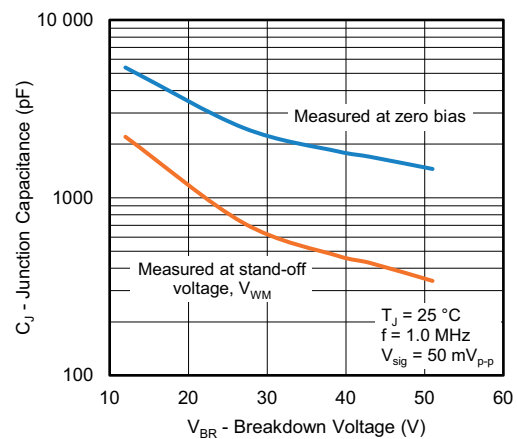

Fig. 4 - Typical Junction Capacitance

**Note**

- Fig.1, power calculations is based on  $I_{PPM}$  times defined maximum clamping voltage by pulse width



## PACKAGE OUTLINE DIMENSIONS in inches (millimeters)

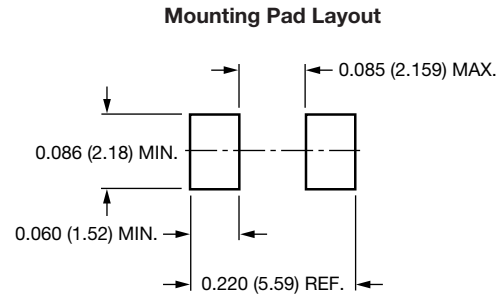
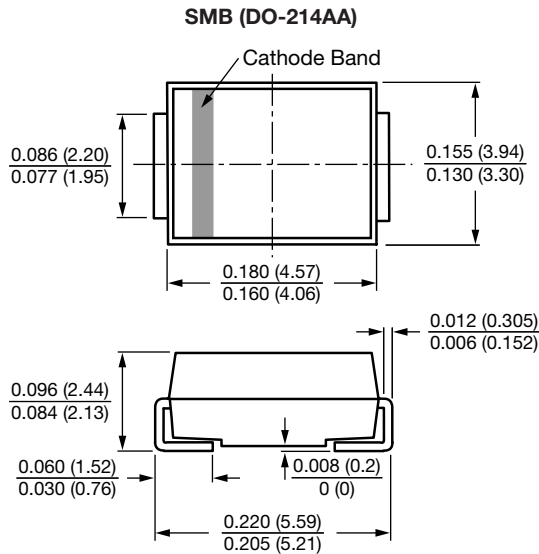



## Disclaimer

ALL PRODUCT, PRODUCT SPECIFICATIONS AND DATA ARE SUBJECT TO CHANGE WITHOUT NOTICE TO IMPROVE RELIABILITY, FUNCTION OR DESIGN OR OTHERWISE.

Vishay Intertechnology, Inc., its affiliates, agents, and employees, and all persons acting on its or their behalf (collectively, "Vishay"), disclaim any and all liability for any errors, inaccuracies or incompleteness contained in any datasheet or in any other disclosure relating to any product.

Vishay makes no warranty, representation or guarantee regarding the suitability of the products for any particular purpose or the continuing production of any product. To the maximum extent permitted by applicable law, Vishay disclaims (i) any and all liability arising out of the application or use of any product, (ii) any and all liability, including without limitation special, consequential or incidental damages, and (iii) any and all implied warranties, including warranties of fitness for particular purpose, non-infringement and merchantability.

Statements regarding the suitability of products for certain types of applications are based on Vishay's knowledge of typical requirements that are often placed on Vishay products in generic applications. Such statements are not binding statements about the suitability of products for a particular application. It is the customer's responsibility to validate that a particular product with the properties described in the product specification is suitable for use in a particular application. Parameters provided in datasheets and / or specifications may vary in different applications and performance may vary over time. All operating parameters, including typical parameters, must be validated for each customer application by the customer's technical experts. Product specifications do not expand or otherwise modify Vishay's terms and conditions of purchase, including but not limited to the warranty expressed therein.

Hyperlinks included in this datasheet may direct users to third-party websites. These links are provided as a convenience and for informational purposes only. Inclusion of these hyperlinks does not constitute an endorsement or an approval by Vishay of any of the products, services or opinions of the corporation, organization or individual associated with the third-party website. Vishay disclaims any and all liability and bears no responsibility for the accuracy, legality or content of the third-party website or for that of subsequent links.

Vishay products are not designed for use in life-saving or life-sustaining applications or any application in which the failure of the Vishay product could result in personal injury or death unless specifically qualified in writing by Vishay. Customers using or selling Vishay products not expressly indicated for use in such applications do so at their own risk. Please contact authorized Vishay personnel to obtain written terms and conditions regarding products designed for such applications.

No license, express or implied, by estoppel or otherwise, to any intellectual property rights is granted by this document or by any conduct of Vishay. Product names and markings noted herein may be trademarks of their respective owners.