

Specification

General tolerances : Max $\pm 0.2\text{mm}[\pm 0.008]$
 Operation Force : $200 \pm 65\text{gf}$ Side Push.
 Stroke : $0.2 \pm 0.1\text{mm}$ Vertical Push
 Electrical Life : 100,000 Cycles Min
 Rating : 50mA, 12V DC

Diagram

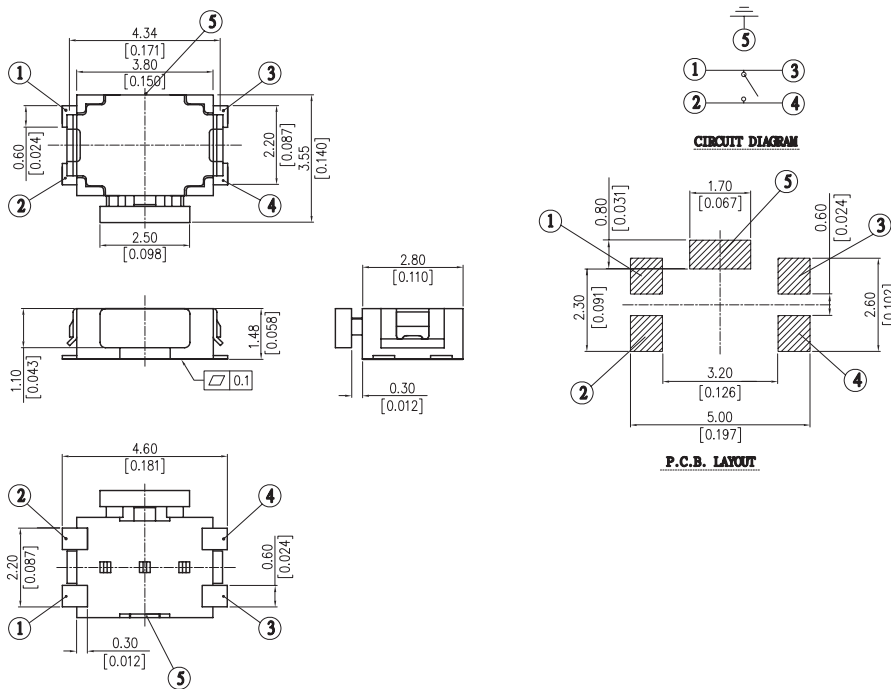

Dimensions : Millimetres (Inches)

Item	Description	Q'ty	Materials	Treatment
1	Cover	1	Stainless Steel	With Silver Plating
2	Spacing Cover			--
3	Stem		High-Temp Thermoplastic	1. Molded Black 2. Molded White
4	Tape		Teflon	--
5	Contact		Stainless Steel	With Silver Cladding
6	Base		High - Temp Thermoplastic	Molded Black
7	Terminal		Phosphor Bronze	1. With Silver Plating 2. Gold Plated

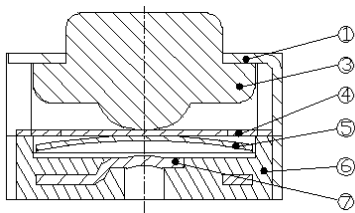

VERTICAL PUSE SWITCH

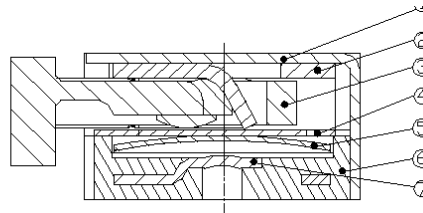

SIDE PUSE SWITCH

1. Style

This specification describes "Tactile Switch", mainly used as signal switch of electric devices, with the general requirements of mechanical and electrical characteristic.

1.1 Operating Temperature Range: -20°C+70°C

1.2 Storage Temperature Range : -30°C+80°C

1.3 The shelf life of product is within 6 months.

2. **Current Range:** 50mA, 12V DC

3. **Type of Actuation:** Tactile feedback

4. **Test Sequence:**

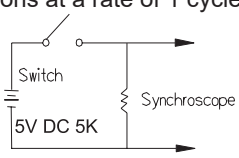
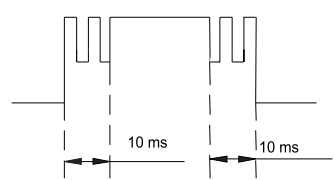
Item	Description	Test Conditions	Requirements
Appearance			
1	Visual Examination	By visual examination check without any out pressure & testing.	There shall be no defects that affect the serviceability of the product.
Electric Performance			
2	Contact Resistance	Applying a static load 1.5-2 times the operating force to the center of the stem, measurements shall be made with a 1 kHz small current contact resistance meter	100mΩ Max.
3	Insulation Resistance	Measurements shall be made following application of 100V DC potential across terminals and cover for 1 minute ± 5 seconds	100MΩ Min.
4	Dielectric Withstanding Voltage	100V AC(50Hz or 60Hz) shall be applied across terminals and cover for 1 minute	There shall be no breakdown or flashover.
5	Capacitance	1 MHz ±10 kHz	5 pF max.
6	Bounce	3 to 4 operations at a rate of 1 cycles per second 	10 ms seconds Max. 

Tactile Switch

Mechanical Performance					
7	Operating Force & Return Force	Applied in the direction of operation. 	--	Side push	Vertical push
			OF	200±65gf (2.0N±.637N)	100±50gf (0.98N±.49N)
					160±50gf (1.568N±.49N)
				160±65gf (1.568N±.637N)	300±80gf (2.94N ± .784N)
400±80gf (3.92N ± .784N)					
8	Stroke	Placing the switch such that the direction of switch operation is vertical and gradually increasing the load applied to the stem, the stroke distance for the stem to come to contact shall be measured	Side push: 0.2±0.1mm Vertical puch: 0.13±0.1mm		
9	Stop Strength	Placing the switch such that the direction of switch operation is vertical, a static load of 3 kgf (29.4N) shall be applied in the direction of stem operation for a period of 15 seconds	As shown item 2~7		
10	Solder Heat Resistance	SMT Type ~ MPIPTG14W-V-T/R Series(4/4)	1. As shown in item 4~7 2. Contact Resistance: 200mΩ Max 3. Insulation Resistance: 10MΩ min 4. Bounce: 20 ms seconds Max		
11	Vibration	Shall be vibrated in accordance with Method 201A of MIL-STD-202F 1. Swing distance=1.5mm 2. Frequency: 10-55-10Hz in 1-min/cycle. 3. Direction: 3 vertical directions including the directions of operation 4. Test time: 2 hours each direction	As shown in item 2~7		
12	Shock	Shall be shocked in accordance with Method 213B condition A of MIL-STD-202F 1) Acceleration: 80G 2) Action time: 11±1m seconds 3) Testing Direction: 6 sides 4) Test Cycle: 3 times in each direction	As shown in item 2~7		
Durability					
13	Operating Life	Measurements shall be made following the test forth below: 1) 5mA, 5V DC resistive load 2) Applying a static load the operating force to the center of the stem in the direction of operation Static Load = OF max. 3. Rate of Operation: 1 operation per second 4. Cycle of Operation: 100,000 Cycle~for 100g, 160g, 200g 50,000 Cycle~for 300g, 400g	1. Operating force: ±50% of initial force 2. Contact Resistance: 200mΩ Max 3. Insulation Resistance: 10MΩ min 4. Bounce: 10 ms seconds Max		

Weather-Proof			
14	Resistance Low Temperature	Following the test set forth below the sample shall be left in normal temperature and humidity conditions for an hour before the measurements are made: 1)Temperature: $-30\pm 2^{\circ}\text{C}$ 2)Time: 96 hours	1)As shown in item 4~7 2)Contact Resistance: 200mΩ Max 3)Insulation Resistance: 10MΩ Min
15	Heat Resistance	Following the test set forth below the sample shall be left in normal temperature and humidity conditions for an hour before the measurements are made: 1)Temperature: $80\pm 2^{\circ}\text{C}$ 2)Time: 96 hours	1)As shown in item 4~7 2)Contact Resistance: 200mΩ Max 3)Insulation Resistance: 10MΩ Min
16	Humidity Resistance	Following the test set forth below the sample shall be left in normal temperature and humidity conditions for an hour before the measurements are made: 1) Temperature: $60\pm 2^{\circ}\text{C}$ 2) Relative Humidity:90~95% 3) Time:96 hours	1) As shown in item 4~7 2) Contact Resistance: 200mΩ Max 3) Insulation Resistance: 10MΩ Min

Soldering Conditions

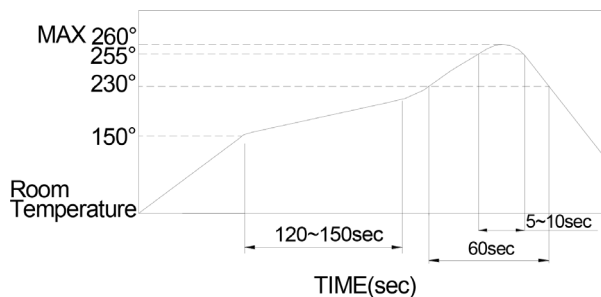

- The condition mentioned above is the temperature on the Cu foil of the PCB surface. There are cases where board's temperature greatly differs from switch's surface be used not to allow switch's surface temperature to exceed 260°C.

- Manual Soldering

Soldering Temperature Max.350°C
 Continuous Soldering Time Max. 5 seconds

Part Number Table

Description	Part Number
Tactile Switch, 2.8mm × 3.8mm, SMT	MPIPTG14W-V-T/R

Important Notice : This data sheet and its contents (the "Information") belong to the members of the AVNET group of companies (the "Group") or are licensed to it. No licence is granted for the use of it other than for information purposes in connection with the products to which it relates. No licence of any intellectual property rights is granted. The Information is subject to change without notice and replaces all data sheets previously supplied. The Information supplied is believed to be accurate but the Group assumes no responsibility for its accuracy or completeness, any error in or omission from it or for any use made of it. Users of this data sheet should check for themselves the Information and the suitability of the products for their purpose and not make any assumptions based on information included or omitted. Liability for loss or damage resulting from any reliance on the Information or use of it (including liability resulting from negligence or where the Group was aware of the possibility of such loss or damage arising) is excluded. This will not operate to limit or restrict the Group's liability for death or personal injury resulting from its negligence. Multicomp Pro is the registered trademark of Premier Farnell Limited 2019.