

# Tactile Switch

**multicomp**PRO

**RoHS  
Compliant**

## Specification

General Tolerances :  $\pm 0.2\text{mm}$   
 Electrical  
 Switch Rating : 50mA, 12V DC  
 Contact Resistance : 100m $\Omega$  Max.  
 Insulation Resistance : 100V DC, 100M $\Omega$  Min.  
 Mechanical

Type	Operation Force	Operation Life	Travel	Contact Material
MPTAEF-25NA-V-T/R	200 $\pm$ 50gf	200,000	0.3 $\pm$ 0.15	Gold
MPTAEF-25SA-V-T/R	450 $\pm$ 110gf	100,000	0.45 $\pm$ 0.15	

## Diagram

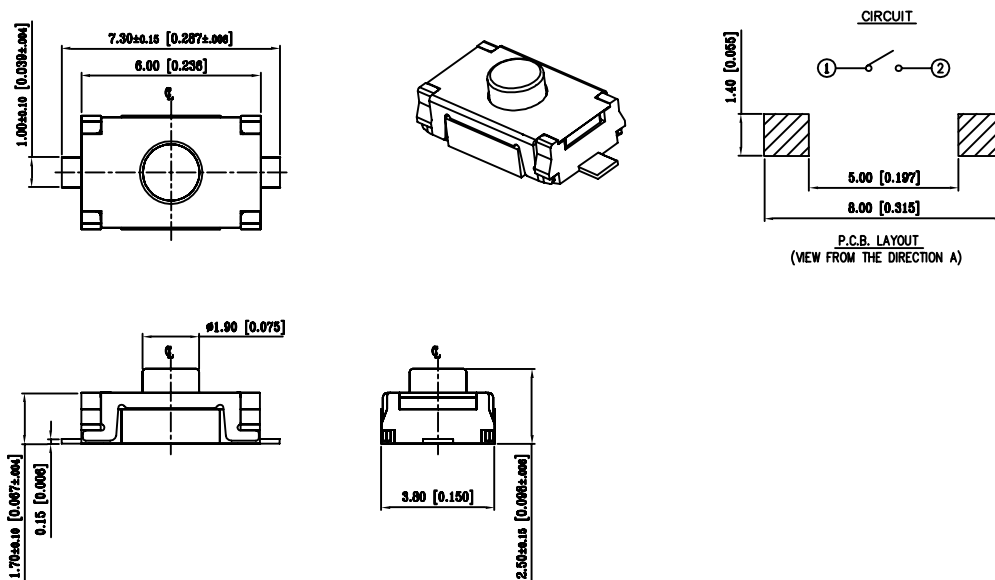

Dimensions : Millimetres (Inches)

Item	Description	Q'ty	Materials	Treatment
1	Terminal Actuator	1	Phosphor Bronze	With Gold Or Silver Plating
2	Dome		Stainless Steel	With Silver Plating
3	Stem		Silicone Rubber	Hardness 80°
4	Cover		Stainless Steel	--
5	Base		High-Temp Thermoplastic LCP V - 0	Black

Newark.com/multicomp-pro  
 Farnell.com/multicomp-pro  
 sg.element14.com/b/multicomp-pro

**multicomp**PRO

# Tactile Switch

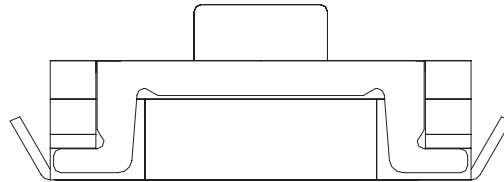
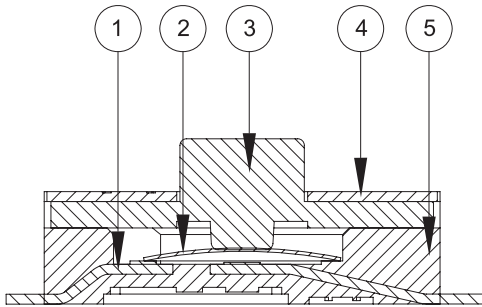

## 1. Style

This specification describes "TACTILE SWITCH", mainly used as signal switch of electric devices, with the general requirements of mechanical and electrical characteristic.

1.1 Operating Temperature Range: -40°C+85°C

1.2 Storage Temperature Range : -40°C+85°C

1.3 The shelf life of product is within 6 months.

2. **Current Range** : 50mA, 12V DC

3. **Type of Actuation**: Tactile feedback

4. **Test Sequence**:

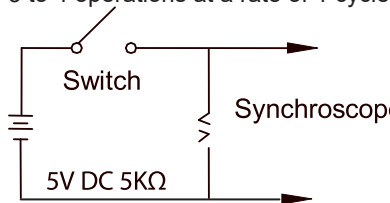
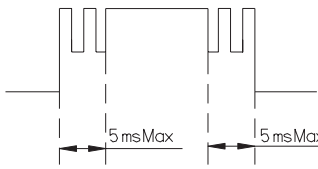
Item	Description	Test Conditions	Requirements
<b>Appearance</b>			
1	Visual Examination	By visual examination check without any out pressure & testing.	There shall be no defects that affect the serviceability of the product.
<b>Electric Performance</b>			
2	Contact Resistance	Applying a static load 1.5-2 times the operating force to the center of the stem, measurements shall be made with a 1 kHz small current contact resistance meter	100mΩ Max
3	Insulation Resistance	Measurements shall be made following application of 100V DC potential across terminals and cover for 1 minute± 5 seconds	100MΩ Min.
4	Dielectric Withstanding Voltage	300V AC(50Hz or 60Hz) shall be applied across terminals and cover for 1 minute	There shall be no breakdown or flashover
5	Capacitance	1 MHz ±10 kHz	5 pF max.
6	Bounce	3 to 4 operations at a rate of 1 cycles per second 	5 m seconds Max. 

# Tactile Switch

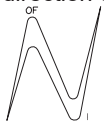
Mechanical Performance					
7	Operation Force	Applied in the direction of operation. 		MPTAEF-25NA-V-T/R	MPTAEF-25SA-V-T/R
			OF	200±50g [1.96±.49N]	450±110g [4.41±1.07N]
8	Stroke	Placing the switch such that the direction of switch operation is vertical and then gradually increasing the load applied to the stem, the stroke distance for the stem to come to a stop shall be measured		MPTAEF-25NA-V-T/R	MPTAEF-25SA-V-T/R
			stroke	0.3±0.15	0.45±0.15
9	Stop Strength	Placing the switch such that the direction of switch operation is vertical, a static load of 3 kgf shall be applied in the direction of stem operation for a period of 15 seconds	1. As shown in item 4~7 2. Contact Resistance: 200mΩ Max 3. Insulation Resistance: 10MΩ Min		
10	Solder Heat Resistance	1) SMT Type: (5/5)	1. Shall be free from pronounced backlash and falling-off or breakage terminals 2. As shown in item 4, 5 3. Contact Resistance: 200mΩ Max 4. Insulation Resistance: 10MΩ Min		
11	Vibration	Shall be vibrated in accordance with Method 201A of MIL-STD-202F 1) Frequency: 10-55-10Hz in 1-min/cycle. 2) Direction: 3 vertical directions including the directions of operation 3) Test time: 2 hours each direction 4) Swing distance=1.5mm	1. As shown in item 4~7 2. Contact Resistance: 200mΩ Max 3. Insulation Resistance: 10MΩ Min		
12	Shock	Shall be shocked in accordance with Method 213B condition A of MIL-STD-202F 1) Acceleration: 50G 2) Action time: 11±1m seconds 3) Testing Direction: 6 sides 4) Test Cycle: 3 times in each direction	1. As shown in item 4~7 2. Contact Resistance: 200mΩ Max 3. Insulation Resistance: 10MΩ Min		
13	Solderability	1. TAE□-25□□-V Soldering Temperature: 245±3°C Lead-Free solder: M705E JIS Z 3282 Class A (Tin 96.5%, Silver 3%, Copper 0.5%) 2. Flux: 5-10 seconds. 3. Duration of solder Immersion: 5±1 sec.	No anti-soldering and the coverage of dipping into solder must more than 75% was requested.		
Durability					
14	Operating Life	Measurements shall be made following the test forth below: 1) 5 mA, 5VDC resistive load 2) Applying a static load the operating force to the center of the stem in the direction of operation Static Load = OF max. 3) Rate of Operation: 1 operation 1 second 4) Cycle of Operation: 200,000 cycles~25N 200,000 cycles~25R 100,000 cycles~25S	1) As shown in item 4~6 2) Operating force: ±50% of initial force. 3) Contact Resistance: 10Ω Max 4) Insulation Resistance: 10MΩ min 5) Bounce: 10 m seconds Max		

Weather-Proof			
15	Resistance Low Temperature	Following the test set forth below the sample shall be left in normal temperature and humidity conditions for an hour before the measurements are made: 1) Temperature: $-40\pm 3^{\circ}\text{C}$ 2) Time: 96 hours	1) As shown in item 4~7 2) Contact Resistance: 200mΩ Max 3) Insulation Resistance: 10MΩ min
16	Resistance High Temperature	Following the test set forth below the sample shall be left in normal temperature and humidity conditions for an hour before the measurements are made: 1. Temperature: $85\pm 2^{\circ}\text{C}$ 2. Time: 96 hours	1) As shown in item 4~7 2) Contact Resistance: 200mΩ Max 3) Insulation Resistance: 10MΩ min
17	Resistance Humidity	Following the test set forth below the sample shall be left in normal temperature and humidity conditions for an hour before the measurements are made: 1) Temperature: $40\pm 2^{\circ}\text{C}$ 2) Relative Humidity: 90~95% 3) Time: 96 hours	1) As shown in item 4~7 2) Contact Resistance: 200mΩ Max 3) Insulation Resistance: 10MΩ min

## Soldering Conditions

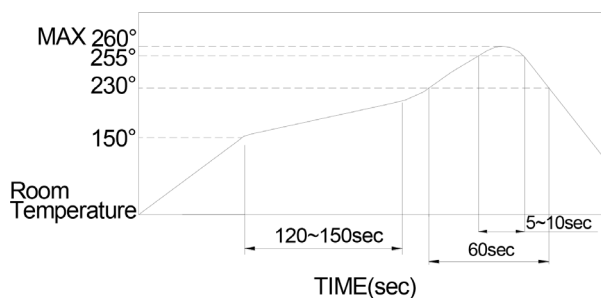

- The condition mentioned above is the temperature on the Cu foil of the PCB surface. There are cases where board's temperature greatly differs from switch's surface temperature depending on board's material, size, thickness, etc. Care, therefore, should be used not to allow switch's surface temperature to exceed 260°C.

### Manual Soldering

Soldering Temperature                      Max. 350°C  
 Continuous Soldering Time                Max. 5 seconds

## Part Number Table

Description	Part Number
Tactile Switch, 3.8mm × 6mm, Flat Pin, H2.5mm, Gold Plating, 200gf	MPTAEF-25NA-V-T/R
Tactile Switch, 3.8mm × 6mm, Flat Pin, H2.5mm, Gold Plating, 450gf	MPTAEF-25SA-V-T/R

**Important Notice :** This data sheet and its contents (the "Information") belong to the members of the AVNET group of companies (the "Group") or are licensed to it. No licence is granted for the use of it other than for information purposes in connection with the products to which it relates. No licence of any intellectual property rights is granted. The Information is subject to change without notice and replaces all data sheets previously supplied. The Information supplied is believed to be accurate but the Group assumes no responsibility for its accuracy or completeness, any error in or omission from it or for any use made of it. Users of this data sheet should check for themselves the Information and the suitability of the products for their purpose and not make any assumptions based on information included or omitted. Liability for loss or damage resulting from any reliance on the Information or use of it (including liability resulting from negligence or where the Group was aware of the possibility of such loss or damage arising) is excluded. This will not operate to limit or restrict the Group's liability for death or personal injury resulting from its negligence. Multicomp Pro is the registered trademark of Premier Farnell Limited 2019.