

NRGC-MBTCP



NRG controller with Modbus TCP Communication



Main features

- **Communication interface.** The NRG controller bridges the field level devices to the control level to allow exchange of data in real-time with the NRG solid state relays.
- **Reduced maintenance costs and downtime.** Use of real-time data for prevention of machine stoppages during operation.
- **Good quality products and low scrap rates.** Real-time monitoring allows timely decisions for better machine and process management.
- **Reduced efforts in troubleshooting.** A number of faults can be distinguished to facilitate and reduce troubleshooting time.
- **Fast installation and set-up.** Control, monitoring and diagnostics all possible via the communication system.
- **Compact dimensions.** One controller with a product width of 35 mm can handle up to 32 RG..CM..N solid state relays.

Description

The **NRGC-MBTCP** is the NRG controller in the NRG BUS chain.

The **NRGC-MBTCP** interfaces directly with the main controller of the system through Modbus TCP communication.

The **NRGC-MBTCP** is mainly a facilitator of the communication between the main controller and each individual RG..N solid state relay in the system. The **NRGC-MBTCP** also performs internal operations to setup and maintain the internal bus.

The **NRGC-MBTCP** needs to be supplied with 24 VDC. LEDs on the front facade give a visual indication of the status of the **NRGC-MBTCP**, of any ongoing communication with the main controller and the RG..Ns on the BUS chain and of any alarm condition related specifically to the **NRGC-MBTCP**.

Specifications are noted at 25°C unless otherwise specified.

Applications

Any heating application where reliable and precise maintenance of temperatures is crucial to the quality of the end product. Typical applications include plastic machinery such as injection machines, extrusion machines and PET blow moulding machines, packaging machinery, sterilisation machinery, drying tunnels and semiconductor manufacturing equipment.

Main function

- Communication interface: Modbus TCP
- Connects up to 32 **RG..CM..Ns**
- Supply voltage 24 VDC +/-20%

The NRG system

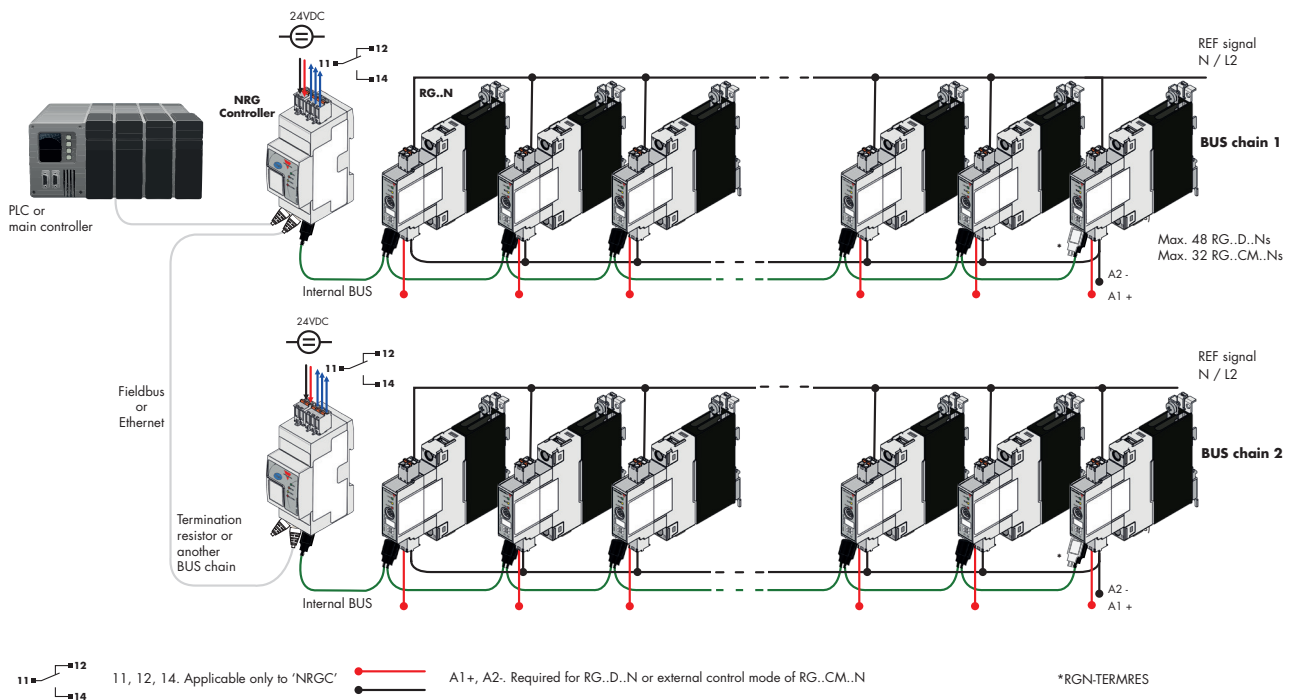

System Overview

The NRG is a system consisting of one or more BUS chains that enable communication between the field devices (such as the solid state relays) and the control devices (such as the machine controller or PLC).

Each **NRG BUS** chain consists of the following 3 components:

- the NRG controller
- the NRG solid state relay(s)
- the NRG internal BUS cables

The **NRG controller** is the interface to the machine controller. It acts as the master of the BUS chain when performing specific actions on the respective BUS chain, and acts as a gateway for the communication between the PLC and the RG..N solid state relays. It is not possible to operate the NRG system without the NRG controller.

The NRG controllers available are:

- **NRGC**

The NRGC is a NRG controller with a Modbus RTU interface over RS485. The NRGC is addressed via the assigned Modbus ID (from 1-247). In a NRG system operating on Modbus it is possible to have 247 NRG BUS chains.

- **NRGC-PN**

NRGC-PN is a NRG controller with a PROFINET communication interface. The NRGC-PN is identified by a unique MAC address which is printed on the facade of the product. The GSD file can be downloaded from www.gavazziautomation.com

- **NRGC-EIP**

NRGC-EIP is a NRG controller with an EtherNet/IP communication interface. The IP address is provided automatically via a DHCP server. The EDS file can be downloaded from www.gavazziautomation.com

- **NRGC-ECAT**

NRGC-ECAT is a NRG controller with an EtherCAT communication interface. The ESI file can be downloaded from www.gavazziautomation.com

- **NRGC-MBTCP**

NRGC-MBTCP is a NRG controller with a Modbus TCP communication interface.

System Overview (continued)

The **NRG solid state relay** is the switching component in the NRG system. Each **RG..N** integrates a communication interface to exchange data with the machine controller (or PLC). The available RG..Ns that can be used in an NRG system are:

- **RG..D..N**

The RG..D..N are solid state relays for use in an NRG system having the communication interface only for real time monitoring. Control of the RG..N is done via a DC control voltage. It is possible to have maximum 48 **RG..D..Ns** in one NRG BUS chain.

- **RG..CM..N**

The RG..CM..N are solid state relays for use in an NRG system having a communication interface for control of the RG..N through the BUS and for real time monitoring. It is possible to have a maximum of 32 RG..CM..N in one NRG bus chain. There are two variants of the RG..CM..N:

RGx1A..CM..N - the solid state relay with zero cross switching

RGx1P..CM..N - the solid state relay with proportional switching.

For a review of the features available in both variants refer to the table below:

Feature	RGx1A..CM..N	RGx1P..CM..N
External control	●	-
ON / OFF switching	●	●
Burst switching	●	●
Distributed full cycle switching	●	●
Advanced full cycle switching	●	●
Phase angle	-	●
Soft start with time mode	-	●
Soft start with current limit mode	-	●
Voltage compensation	-	●
Monitoring of system parameters	●	●
SSR diagnostics	●	●
Load diagnostics	●	●
Overtemperature protection	●	●

It is not possible to mix RG..D..N and RG..CM..N in the same BUS chain.

The **NRG internal BUS cables** are proprietary cables that connect the NRG controller to the first RG..N in the NRG BUS chain and respective RG..Ns on the BUS. The internal BUS terminator, provided in the same package with the NRG controller, shall be plugged to the last RG..N in the NRG BUS chain.

NRG system required components

Description	Component code	Notes
Solid state relays	RG..N	NRG solid state relays
NRG controller	NRGC..	<ul style="list-style-type: none"> • NRGC: NRG controller with Modbus RTU communication. • NRGC-PN: NRG controller with PROFINET communication. • NRGC-EIP: NRG controller with EtherNet/IP communication. • NRGC-ECAT: NRG controller with EtherCAT communication • NRGC-MBTCP: NRG controller with Modbus TCP communication 1x RGN-TERMRES is included in the NRGC.. packaging. The RGN-TERMRES is to be mounted on the last RG..N on the bus chain.
NRG internal BUS cables	RRCGN-xxx	Proprietary cables terminated at both ends with a micro USB connector



List of contents

NRGC-MBTCP	
References	5
Structure	6
General data	7
Dimensions	7
Power supply specifications	7
Auto-addressing	8
Communications	9
Internal bus	9
Compatibility and conformance	10
Environmental specifications	11
LED indicators	11
Alarm management	12
Connection diagram	12
Mounting	13
Connection specifications	14
RCRGN	15

References

Order code



NRGC-MBTCP

Carlo Gavazzi compatible components

Description	Component code	Notes
Solid state relays	RG..CM..N	NRG solid state relays <ul style="list-style-type: none"> RG..CM..N: Communication interface for control of the RG..N and for real time monitoring. Maximum 32x RG..CM..N in one BUS chain.
NRG Internal BUS cables	RCRGN-010-2	10cm cable terminated at both ends with a microUSB connector. Packed x4 pcs.
	RCRGN-025-2	25cm cable terminated at both ends with a microUSB connector. Packed x1 pc.
	RCRGN-075-2	75cm cable terminated at both ends with a microUSB connector. Packed x1 pc.
	RCRGN-150-2	150cm cable terminated at both ends with a microUSB connector. Packed x1 pc.
	RCRGN-350-2	350cm cable terminated at both ends with a microUSB connector. Packed x1 pc.
	RCRGN-500-2	500cm cable terminated at both ends with a microUSB connector. Packed x1 pc.

Further reading

Information	Where to find it	
User manual NRG Modbus TCP	http://cga.pub/?6d9c75	
Datasheet RG..CM..N solid state relay with control and real time moni- toring via bus	http://cga.pub/?77600f	

Structure

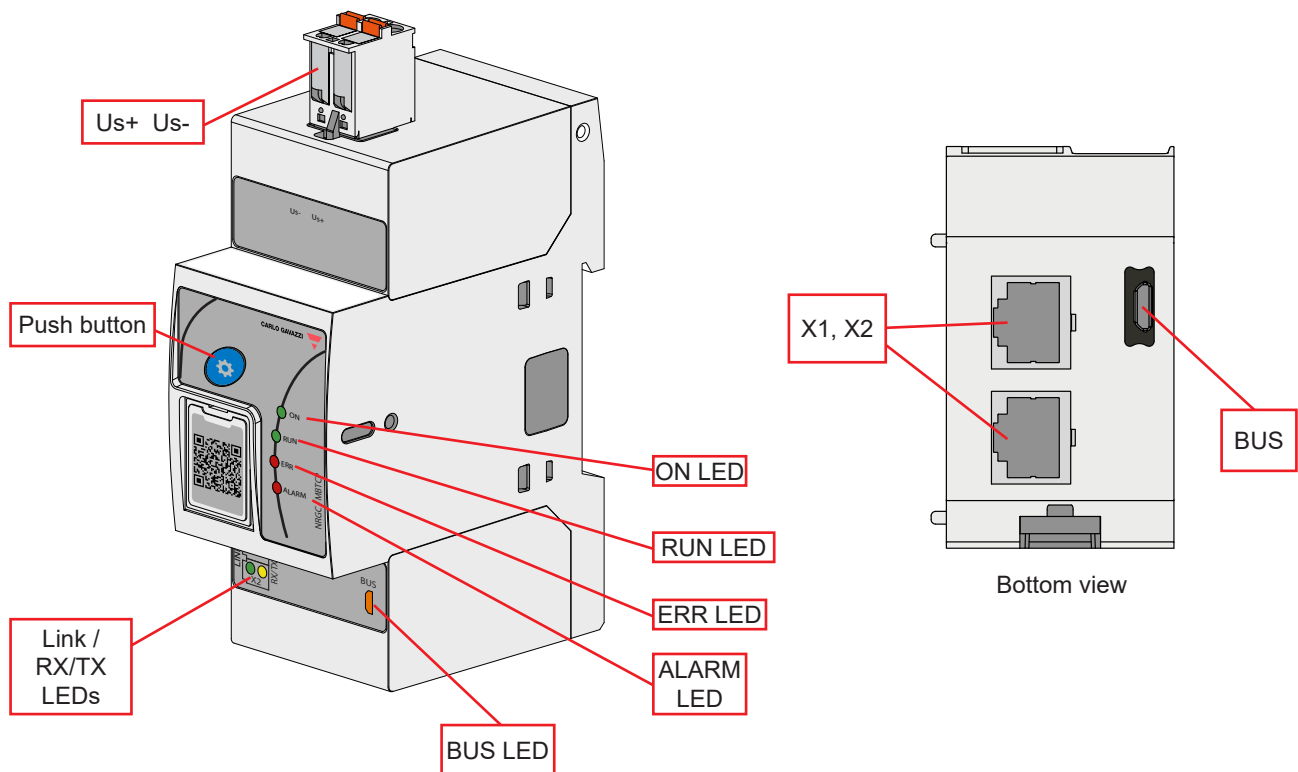

Element	Component	Function
Us+ Us-	Supply connection	2 position spring plug – Us-, Us+ connection for powering the NRG-C-MBTCP
Push button	Communications check & Autoaddressing button	Enables and disables a Communications Check function of the BUS chain (link between NRG-C-MBTCP and RG..Ns) by pressing front button between 2 to 5 seconds Enables auto addressing of RG..Ns when pressed for 3 seconds during power up. Check 'Autoaddressing' section for more info.
ON LED	ON indicator	Indicates presence of supply voltage on NRG-C-MBTCP
BUS LED	BUS indicator	Indicates ongoing communication with RG..Ns
RUN LED	Modbus TCP status	Status of TCP connection
ERR LED	Modbus TCP error	Indicates communication and system errors
ALARM LED	ALARM indicator	Indicates presence of an alarm condition
Link / RX/TX LEDs	Link/Activity indicators	Indicates the status of the physical Ethernet connection
X1,X2	Ethernet ports	2x RJ45 plugs for Modbus TCP communication
BUS	Micro-USB port – internal BUS	RCRGN cable connection for the internal BUS communications line

Features

General data

Material	Noryl (UL94 V0), RAL7035
Mounting	DIN rail
Dimensions	2-DIN
Touch protection	IP20, IP00 with door flap on front facade open
Weight	142 g
Compatibility	RGC..CM..N solid state contactors (RG end-devices) RGS..CM..N solid state relays (RG end-devices)

Dimensions

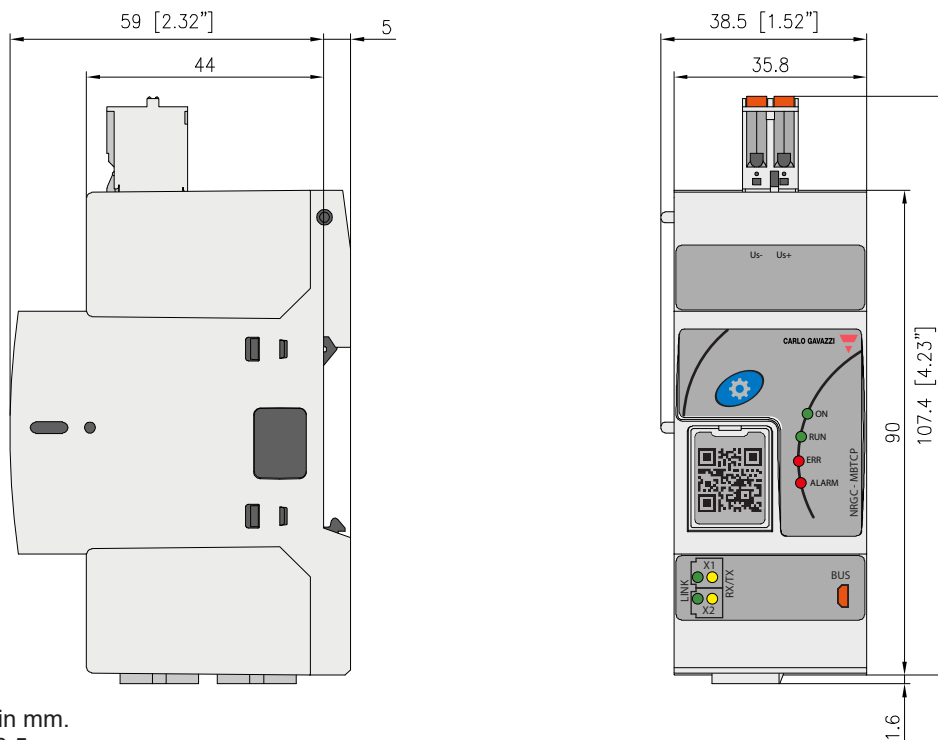

All dimensions in mm.
Tolerances +/- 0.5 mm.

Performance

Power supply specifications

Supply port rating, Us	24 VDC
Supply voltage range, Us	19.2 – 32 VDC*
Reverse polarity protection	Yes
Consumption	< 12 W
LED Indication, Supply ON	Green LED
Power on	2 s

* to be supplied by class 2 power source according to UL1310

Auto-addressing

The RG..Ns on the bus chain are automatically addressed upon the first start-up of the system. The RG..Ns are addressed based on their position on the bus chain.

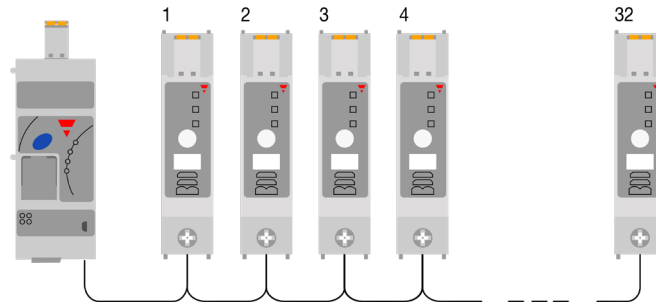

In case of an RG..N replacement, or any changes to the NRG bus chain, the RG..Ns have to be re-addressed. Follow the procedure below to re-address the RG..Ns on the NRG bus chain manually. Alternatively, auto-addressing can be done via communication. (check NRG Modbus TCP User Manual for further information)

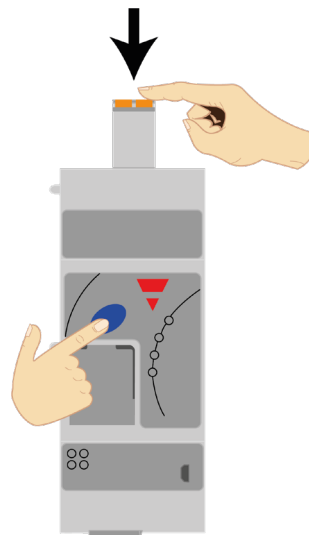

Fig. 1 Hold the blue button while powering up the NRG-MBTCP

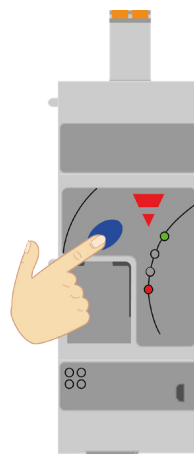

Fig. 2 Release when Alarm LED turns ON indicating that autoaddressing is complete





Communication

Communication protocol to Main Controller	Modbus TCP
Default communication settings	<p>Default IP address 192.168.1.[last byte of the MAC address] If for example the MAC address is 68-49-B2-00-00-05, the default IP address configured is 192.168.1.5</p> <p>As a reference, the default IP address in full is listed on the side label of the NRGC-MBTCP</p> <p>Default subnet netmask 255.255.255.0 Default gateway 192.168.1.25</p> <p>For more information please refer to NRG Modbus TCP user manual</p>
Communication interface	The ethernet ports are 100 Mbit, full duplex operation ports and should be connected to another Modbus TCP device with a standard ethernet cable via the standard RJ45 connector (maximum length 100 m)
LED indication - RX/TX	Yellow, Flashing - NRGC-MBTCP is sending/receiving Ethernet frames
LED indication - Link	Green, ON - Device is linked to Ethernet

Internal Bus

Max. number of RG..Ns connected to NRGC-MBTCP	32x RG..CM..N
Connection to RG..Ns	RCRGN-xx 5-way cable terminated with micro-USB connection
BUS termination	RGN-TERMRES (1x pc. provided with 1x NRGC-MBTCP) to be plugged on the last RG..N on the BUS chain to terminate the internal BUS
LED indication - BUS	Yellow, ON indicating ongoing communication with the RG end-devices

Compatibility and Conformance

Approvals	   
Standards compliance	LVD: EN 60947-5-1 EMCD: EN 60947-5-1 EE: EN 60947-5-1 EMC: EN 60947-5-1 UL: UL508 (E172877), NMFT cUL: C22.2 No. 14 (E172877), NMFT7

Electromagnetic compatibility (EMC) - Immunity	
Electrostatic discharge (ESD)	EN/IEC 61000-4-2 8 kV air discharge, 4 kV contact (PC1)
Radiated radio frequency	EN/IEC 61000-4-3 10 V/m, from 80 MHz to 1 GHz (PC1) 10 V/m, from 1.4 to 2 GHz (PC1) 3 V/m, from 2 to 2.7 GHz (PC1)
Electrical fast transient (burst)	EN/IEC 61000-4-4 Input: 1 kV, 5 kHz & 100 kHz (PC1) Internal bus: 1 kV, 5 kHz & 100 kHz (PC1) Ethernet ports: 1 kV, 5 kHz & 100 kHz (PC1) 2 kV, 5 kHz & 100 kHz (PC2)
Conducted radio frequency	EN/IEC 61000-4-6 10 V/m, from 0.15 to 80 MHz (PC1)
Electrical surge	EN/IEC 61000-4-5 DC Output / Input, line to line: 500 V (PC2) DC Output / Input, line to earth: 500 V (PC2) Signal, line to earth 1 kV (PC2) ¹
Voltage dips and interruptions	EN/IEC 61000-4-11 0% @ 5000 ms (PC2) 40% @ 200 ms (PC2) 60% @ 10, 30, 100, 300, 1000 ms (PC2)
Voltage dips and interruptions on input lines	EN/IEC 61000-4-29 0% @ 1, 3, 10, 30, 100, 300, 1000 ms (PC2) 30% @ 10, 30, 100, 300, 1000 ms (PC2) 70% @ 10, 30, 100, 300, 1000 ms (PC2) 80% @ 10, 30, 100, 300, 1000 ms, 3 s, 10 s (PC2) 120% @ 10, 30, 100, 300, 1000 ms, 3 s, 10 s (PC2)







1. Not applicable to shielded cables <10m. Additional suppression on data lines may be required if shielded cables are not used.

Electromagnetic compatibility (EMC) - Emissions	
Radio interference field emission (radiated)	EN/IEC 55011 Class A: from 30 to 1000 MHz
Radio interference voltage emissions (conducted)	EN/IEC 55011 Class B: from 0.15 to 30 MHz

Environmental specifications

Operating temperature	-20 to +65 °C (-4 to +149 °F)
Storage temperature	-20 to +65 °C (-4 to +149 °F)
Relative humidity	95% non-condensing @ 40°C
Pollution degree	2
Installation altitude	0 - 2000m
EU RoHS compliant	Yes
China RoHS	

LED indicators

ON	Green 	ON:	Us is present at terminals Us+, Us-
		OFF:	Us is not present at terminals Us+, Us-
LINK	Green 	ON:	Device is linked to Ethernet
		OFF:	Device has no link to Ethernet
RX/TX	Yellow 	OFF:	No frames are being sent/received
		Flashing:	NRGC-MBTCP is sending/receiving Ethernet frames
BUS	Yellow 	ON:	During transmission of messages from NRGC-MBTCP to RG..Ns
		OFF:	Idle bus between the NRGC-MBTCP and RG..Ns and when NRGC-MBTCP is receiving data from RG..Ns
ALARM	Red 	ON:	Flashing when alarm condition on NRGC-MBTCP is present. Refer to Alarm management section
		OFF:	No alarm condition
RUN	Green 	ON:	Connected: OMB task has communication. At least one TCP connection is established
		Flashing (1Hz):	Ready, not configured yet: OMB task is ready and not yet configured
		Flashing (5Hz):	Waiting for communication: OMB task is configured
		OFF:	Not ready: OMB task is not ready
ERR	Red 	ON:	Communication error active
		Flashing:	System error
		OFF:	No communication error

Alarm management

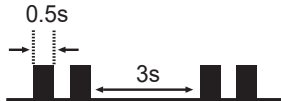
Alarm condition present	<ul style="list-style-type: none"> • ALARM LED ON with a specific flashing rate • Alarms are also available as process data via the Modbus TCP communication interface. Refer to NRG Modbus TCP User Manual for further information 	
Alarm types	No. of flashes	Description of fault
	2	Errors in the configurations of the internal NRG bus chain including: <ul style="list-style-type: none"> • Number of RG..Ns on bus chain is > 32 (Device Limit Error) • More than one RG..N on the bus chain have the same address (Device conflict error) • One of the RG..Ns does not have an address. This may occur when a new RG..N is introduced to the bus chain (Device Unconfigured Error) • The internal Device ID of one of the RG..Ns on the bus chain does not correspond to its position on the bus (Device Position Error)
	4	Supply Error: Supply to NRG-MBTCP is outside of the specified range
	8	Communication Error (BUS): An error in the communication link (internal BUS) between the NRG-MBTCP and RG..Ns
	9	Internal Error: Detection of internal issues with the NRG-MBTCP
10	Termination (BUS) Error: Internal BUS chain not terminated	
Flashing rate		

Connection diagram

The NRG bus chain can be configured in a Modbus TCP network via a line, ring, star or tree topologies via the ethernet ports on the NRG-MBTCP.

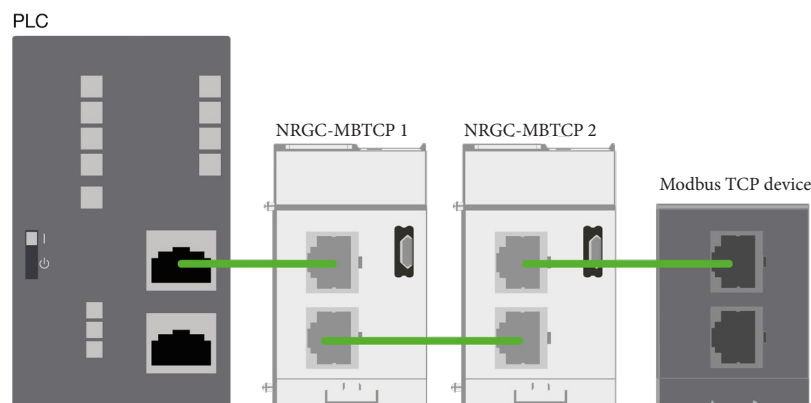
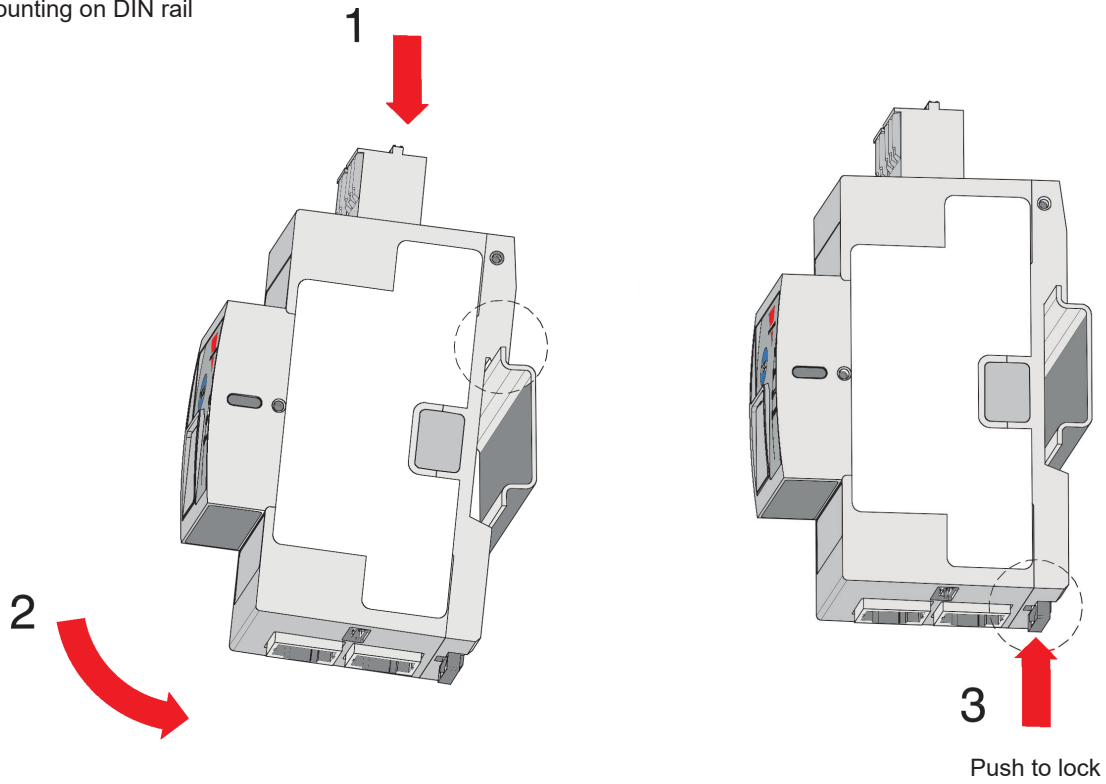

Fig. 3 Example of a line configuration of the NRG-MBTCP with other Modbus TCP devices and controller

▶ Mounting

Mounting on DIN rail



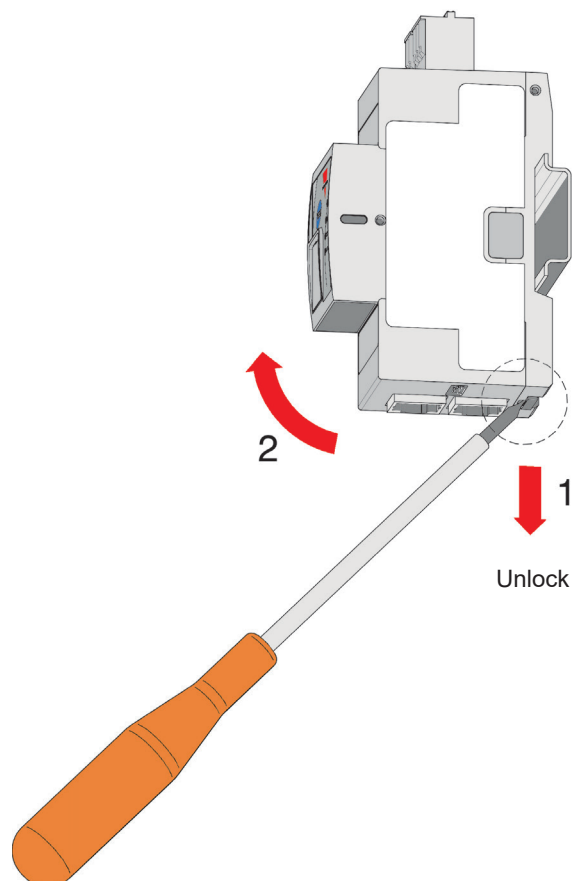

Dismounting from DIN rail

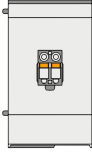

RCRGN..

 Connection specifications

Power connection	
Terminal	Supply: Us+, Us-
	 <p>Top view</p>
Conductors	Use 60/75°C copper (Cu) conductors
Stripping length	12 - 13 mm
Connection type	2-pole spring plug, pitch 5.08 mm
Rigid (solid & stranded) UL/CSA rated data	0.2 – 2.5 mm ² , 26 – 12 AWG
Flexible with end sleeve	0.25 – 2.5 mm ²
Flexible without end sleeve	0.25 – 2.5 mm ²
Flexible with end sleeve using TWIN ferrules	0.5 – 1.0 mm ²

Communication - connection	
Terminal	X1, X2: RJ45 (x2) BUS: RCRGN-xxx-2
	 <p>Bottom view</p>
Modbus TCP connection	RJ45 shielded plugs
Cable for Modbus TCP	Not provided..
Max. length of Ethernet cable	100 mtrs (between Modbus TCP devices)
Cable for Internal Bus	RCRGN-xxx-2: 5-way USB micro connection <ul style="list-style-type: none"> - +24 supply line for RG..Ns - GND - RS485A - RS485B - Autoconfig / Auto addressing line

NRG internal BUS cable



Main features

- Cables available at various lengths to provide the internal BUS of the NRG system
- Cables terminated at both ends with a microUSB plug
- Connects the NRG controller to the RG..N solid state relay and respective RG..N solid state relays

Description

The **RCRGN** cables are proprietary cables that must be used with the NRG system for the internal BUS. These cables connect the NRG controller to the RG..N solid state relays and respective RG..N solid state relays.

The RCRGN... are 5-way cables carrying the communication, supply and autoconfiguration / auto-addressing lines. By means of autoconfiguration / auto-addressing, the RG..Ns are assigned a unique ID based on the physical location and on the internal BUS.

Carlo Gavazzi compatible components

Description	Component code	Notes
NRG Controller	NRGC..	<ul style="list-style-type: none"> • NRGC: NRG controller with Modbus communication. • NRGC-PN: NRG controller with PROFINET communication. • NRGC-EIP: NRG controller with EtherNet/IP communication. • NRGC-ECAT: NRG controller with EtherCAT communication. • NRGC-MBTCP: NRG controller with Modbus TCP communication. 1x RGN-TERMRES is included in the NRGC.. packaging. The RGN-TERMRES is to be mounted on the last RG..N on the bus chain.
Solid state relays	RG..N	NRG solid state relays

Order code

 **RCRGN - - 2**

Enter the code entering the corresponding option instead of

Code	Option	Description	Notes	
R	-	Cables		
C	-			
R	-			
G	-		Suitable for the NRG system	
N	-			
<input type="checkbox"/>	010	10 cm cable length	packed x 4 pcs.	
	025	25 cm cable length	packed x 1 pc.	
	075	75 cm cable length	packed x 1 pc.	
	150	150 cm cable length	packed x 1 pc.	
	350	350 cm cable length	packed x 1 pc.	
	500	500 cm cable length	packed x 1 pc.	
2	-	Terminated at the both ends with a microUSB connector		



COPYRIGHT ©2022
Content subject to change.
Download the PDF: <http://gavazziautomation.com>