

## Target datasheet

### 62 mm C-Series module with CoolSiC™ Trench MOSFET and pre-applied thermal interface material

#### Features

- Electrical features
  - $V_{DSS} = 1200\text{ V}$
  - $I_{DN} = 280\text{ A} / I_{DRM} = 560\text{ A}$
  - High current density
  - Low switching losses
- Mechanical features
  - 4 kV AC 1 min insulation
  - Pre-applied thermal interface material



#### Potential applications

- UPS systems
- Solar applications
- DC/DC converter
- High-frequency switching application
- Energy storage systems
- DC charger for EV

#### Product validation

- Qualified for industrial applications according to the relevant tests of IEC 60747, 60749 and 60068

#### Description

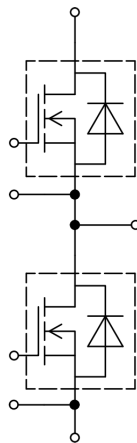

## Table of contents

	<b>Description</b> .....	1
	<b>Features</b> .....	1
	<b>Potential applications</b> .....	1
	<b>Product validation</b> .....	1
	<b>Table of contents</b> .....	2
<b>1</b>	<b>Package</b> .....	3
<b>2</b>	<b>MOSFET</b> .....	3
<b>3</b>	<b>Body diode (MOSFET)</b> .....	5
<b>4</b>	<b>Characteristics diagrams</b> .....	6
<b>5</b>	<b>Circuit diagram</b> .....	9
<b>6</b>	<b>Package outlines</b> .....	10
<b>7</b>	<b>Module label code</b> .....	11
	<b>Revision history</b> .....	12
	<b>Disclaimer</b> .....	13

## 1 Package

**Table 1** Insulation coordination

Parameter	Symbol	Note or test condition	Values	Unit
Isolation test voltage	$V_{ISOL}$	RMS, $f = 50 \text{ Hz}$ , $t = 60 \text{ s}$	4.0	kV
Material of module baseplate			Cu	
Internal isolation		basic insulation (class 1, IEC 61140)	$\text{Al}_2\text{O}_3$	
Creepage distance	$d_{Creep}$	terminal to heatsink	29.0	mm
Creepage distance	$d_{Creep}$	terminal to terminal	23.0	mm
Clearance	$d_{Clear}$	terminal to heatsink	23.0	mm
Clearance	$d_{Clear}$	terminal to terminal	11.0	mm
Comparative tracking index	$CTI$		> 400	
Relative thermal index (electrical)	$RTI$	housing	140	°C

**Table 2** Characteristic values

Parameter	Symbol	Note or test condition	Values			Unit
			Min.	Typ.	Max.	
Stray inductance module	$L_{SCE}$			20		nH
Module lead resistance, terminals - chip	$R_{CC'+EE'}$	$T_H = 25 \text{ °C}$ , per switch		0.475		mΩ
Storage temperature	$T_{stg}$		-40		125	°C
Maximum baseplate operation temperature	$T_{BPmax}$				125	°C
Mounting torque for module mounting	$M$	- Mounting according to valid application note	M6, Screw	3	6	Nm
Terminal connection torque	$M$	- Mounting according to valid application note	M6, Screw	2.5	5	Nm
Weight	$G$			340		g

Note: Storage and shipment of modules with TIM => see AN2012-07.

## 2 MOSFET

**Table 3** Maximum rated values

Parameter	Symbol	Note or test condition	Values	Unit
Drain-source voltage	$V_{DSS}$	$T_{Vj} = 25 \text{ °C}$	1200	V
Implemented drain current	$I_{DN}$		280	A

(table continues...)

**Table 3 (continued) Maximum rated values**

Parameter	Symbol	Note or test condition	Values	Unit
Continuous DC drain current	$I_{DDC}$	$T_{vj} = 175\text{ °C}$ , $V_{GS} = 18\text{ V}$ $T_H = 65\text{ °C}$	220	A
Repetitive peak drain current	$I_{DRM}$	verified by design, $t_p$ limited by $T_{vjmax}$	560	A
Gate-source voltage, max. transient voltage	$V_{GS}$	$D < 0.01$	-10/23	V
Gate-source voltage, max. static voltage	$V_{GS}$		-7/20	V

**Table 4 Recommended values**

Parameter	Symbol	Note or test condition	Values	Unit
On-state gate voltage	$V_{GS(on)}$		15...18	V
Off-state gate voltage	$V_{GS(off)}$		-5...0	V

**Table 5 Characteristic values**

Parameter	Symbol	Note or test condition	Values			Unit	
			Min.	Typ.	Max.		
Drain-source on-resistance	$R_{DS(on)}$	$I_D = 280\text{ A}$	$V_{GS} = 18\text{ V}$ , $T_{vj} = 25\text{ °C}$		2.94	4.44	mΩ
			$V_{GS} = 18\text{ V}$ , $T_{vj} = 125\text{ °C}$		4.76		
			$V_{GS} = 18\text{ V}$ , $T_{vj} = 175\text{ °C}$		6.32		
			$V_{GS} = 15\text{ V}$ , $T_{vj} = 25\text{ °C}$		3.54		
Gate threshold voltage	$V_{GS(th)}$	$I_D = 112\text{ mA}$ , $V_{DS} = V_{GS}$ , $T_{vj} = 25\text{ °C}$ , (tested after 1ms pulse at $V_{GS} = +20\text{ V}$ )	3.5	4.3	5.1	V	
Total gate charge	$Q_G$	$V_{DD} = 800\text{ V}$ , $V_{GS} = -3/18\text{ V}$		0.8		μC	
Internal gate resistor	$R_{Gint}$	$T_{vj} = 25\text{ °C}$		1.9		Ω	
Input capacitance	$C_{ISS}$	$f = 100\text{ kHz}$ , $V_{DS} = 800\text{ V}$ , $V_{GS} = 0\text{ V}$ $T_{vj} = 25\text{ °C}$		24.2		nF	
Output capacitance	$C_{OSS}$	$f = 100\text{ kHz}$ , $V_{DS} = 800\text{ V}$ , $V_{GS} = 0\text{ V}$ $T_{vj} = 25\text{ °C}$		1.2		nF	
Reverse transfer capacitance	$C_{rSS}$	$f = 100\text{ kHz}$ , $V_{DS} = 800\text{ V}$ , $V_{GS} = 0\text{ V}$ $T_{vj} = 25\text{ °C}$		0.079		nF	
$C_{OSS}$ stored energy	$E_{OSS}$	$V_{DS} = 800\text{ V}$ , $V_{GS} = -3/18\text{ V}$ , $T_{vj} = 25\text{ °C}$		473		μJ	
Drain-source leakage current	$I_{DSS}$	$V_{DS} = 1200\text{ V}$ , $V_{GS} = -3\text{ V}$ $T_{vj} = 25\text{ °C}$		0.16	378	μA	

**(table continues...)**

**Table 5 (continued) Characteristic values**

Parameter	Symbol	Note or test condition		Values			Unit
				Min.	Typ.	Max.	
Gate-source leakage current	$I_{GSS}$	$V_{DS} = 0\text{ V}$ , $T_{vj} = 25\text{ °C}$	$V_{GS} = 20\text{ V}$			400	nA
Thermal resistance, junction to heat sink	$R_{thJH}$	per MOSFET, Valid with IFX pre-applied Thermal Interface Material				0.233	K/W
Temperature under switching conditions	$T_{vj,op}$			-40		175	°C

*Note:* The selection of positive and negative gate-source voltages impacts losses and the long-term behavior of the MOSFET and body diode. The design guidelines described in Application Notes AN 2018-09 and AN 2021-13 must be considered to ensure sound operation of the device over the planned lifetime.

$T_{vj,op} > 150\text{ °C}$  is allowed for operation at overload conditions for MOSFET and body diode. For detailed specifications, please refer to AN 2021-13.

### 3 Body diode (MOSFET)

**Table 6 Maximum rated values**

Parameter	Symbol	Note or test condition		Values	Unit
DC body diode forward current	$I_{SD}$	$T_{vj} = 175\text{ °C}$ , $V_{GS} = -3\text{ V}$	$T_H = 65\text{ °C}$	115	A

**Table 7 Characteristic values**

Parameter	Symbol	Note or test condition		Values			Unit
				Min.	Typ.	Max.	
Forward voltage	$V_{SD}$	$I_{SD} = 280\text{ A}$ , $V_{GS} = -3\text{ V}$	$T_{vj} = 25\text{ °C}$		4.22	5.59	V
			$T_{vj} = 125\text{ °C}$		3.95		
			$T_{vj} = 175\text{ °C}$		3.85		

## 4 Characteristics diagrams

**Output characteristic (typical), MOSFET**

$I_D = f(V_{DS})$   
 $V_{GS} = 18\text{ V}$

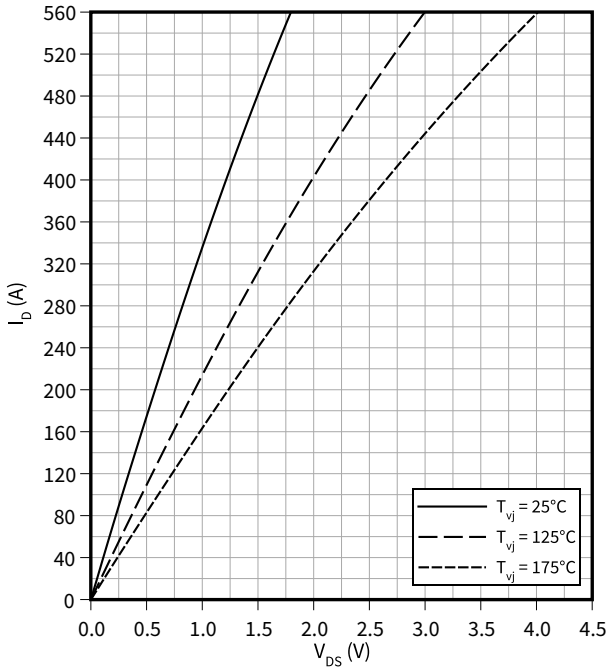

**Output characteristic (typical), MOSFET**

$I_D = f(V_{DS})$   
 $V_{GS} = 15\text{ V}$

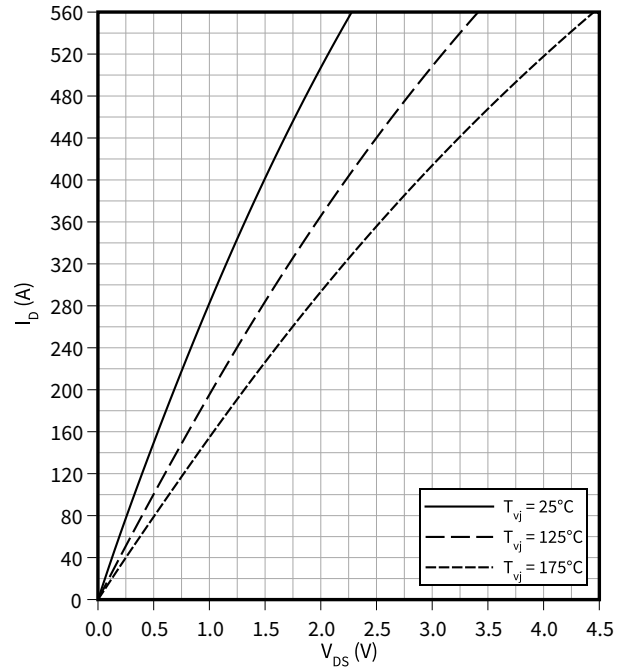

**Output characteristic field (typical), MOSFET**

$I_D = f(V_{DS})$   
 $T_{vj} = 175\text{ °C}$

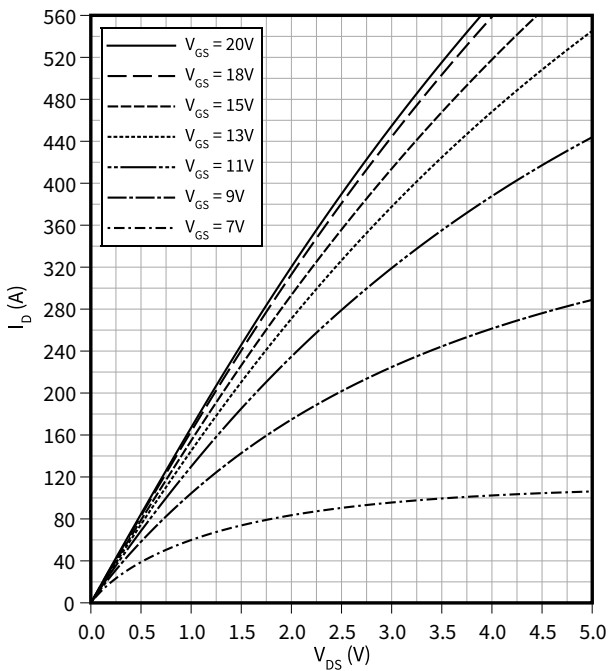

**Drain source on-resistance (typical), MOSFET**

$R_{DS(on)} = f(I_D)$   
 $V_{GS} = 18\text{ V}$

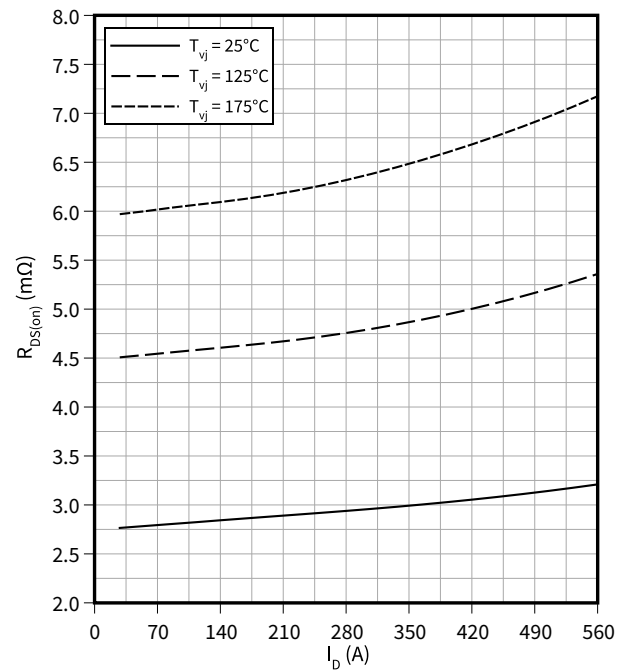

4 Characteristics diagrams

**Drain source on-resistance (typical), MOSFET**

$R_{DS(on)} = f(T_{vj})$   
 $I_D = 280 \text{ A}$

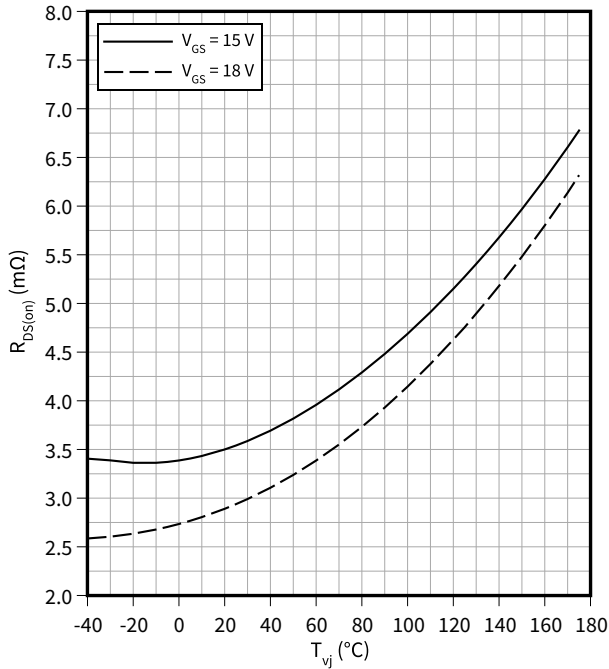

**Transfer characteristic (typical), MOSFET**

$I_D = f(V_{GS})$   
 $V_{DS} = 20 \text{ V}$

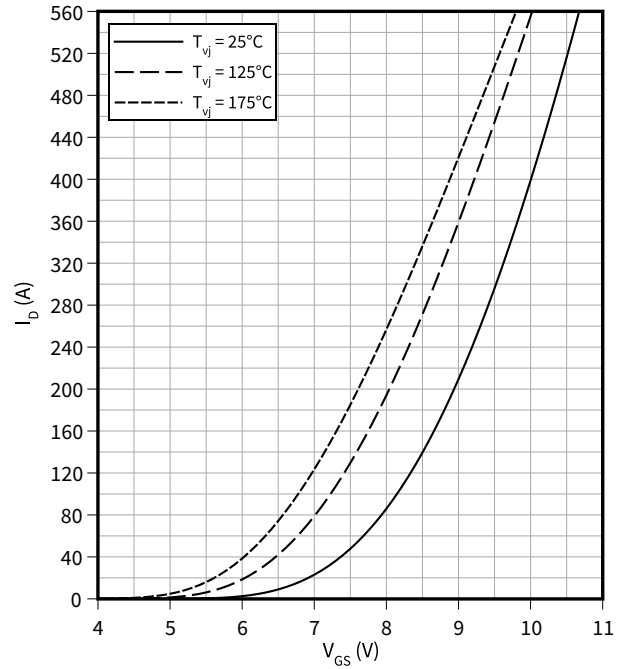

**Gate-source threshold voltage (typical), MOSFET**

$V_{GS(th)} = f(T_{vj})$   
 $V_{GS} = V_{DS}$

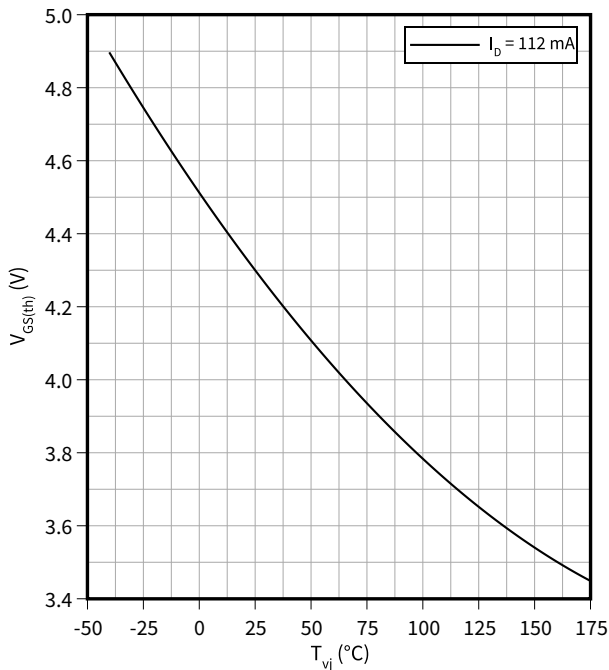

**Gate charge characteristic (typical), MOSFET**

$V_{GS} = f(Q_G)$   
 $I_D = 280 \text{ A}, T_{vj} = 25 \text{ °C}$

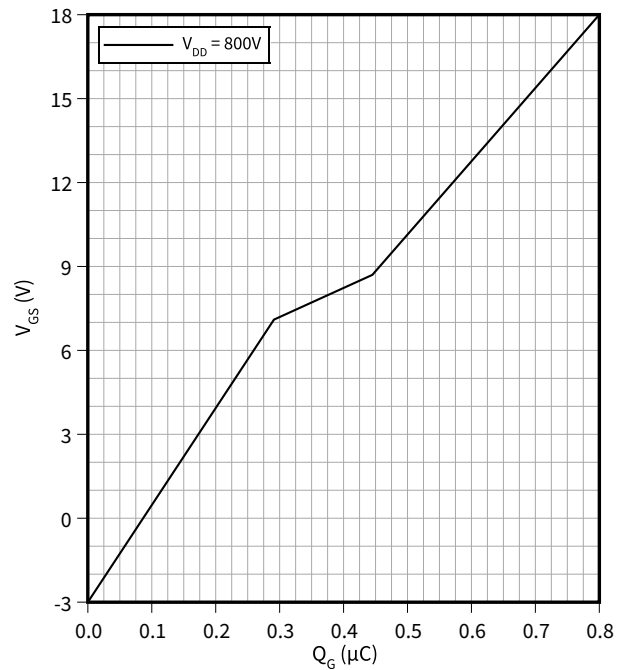

4 Characteristics diagrams

**Capacity characteristic (typical), MOSFET**

$C = f(V_{DS})$

$f = 100 \text{ kHz}, T_{vj} = 25 \text{ }^\circ\text{C}, V_{GS} = 0 \text{ V}$

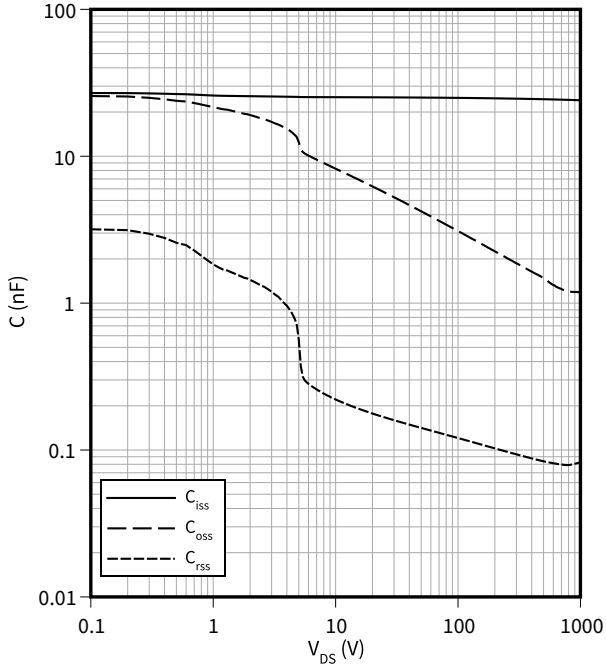

**Transient thermal impedance, MOSFET**

$Z_{th} = f(t)$

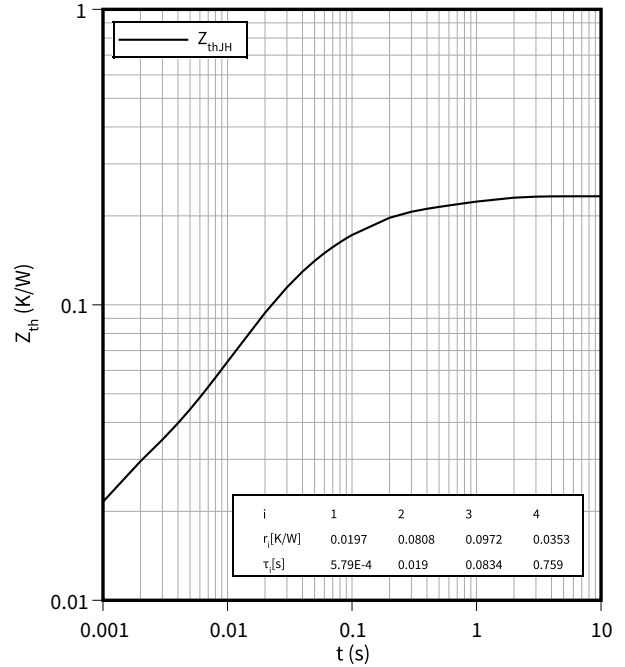

**Forward characteristic body diode (typical), MOSFET**

$I_{SD} = f(V_{SD})$

$T_{vj} = 25 \text{ }^\circ\text{C}$

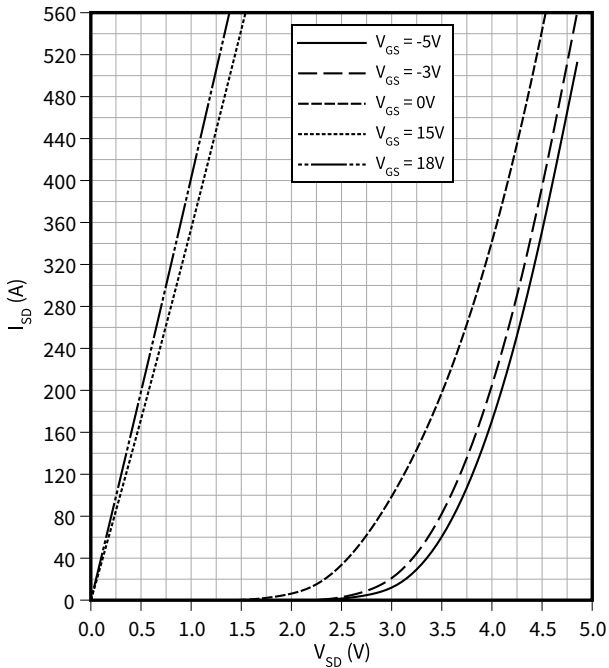

**Forward voltage of body diode (typical), MOSFET**

$V_{SD} = f(T_{vj})$

$I_{SD} = 280 \text{ A}$

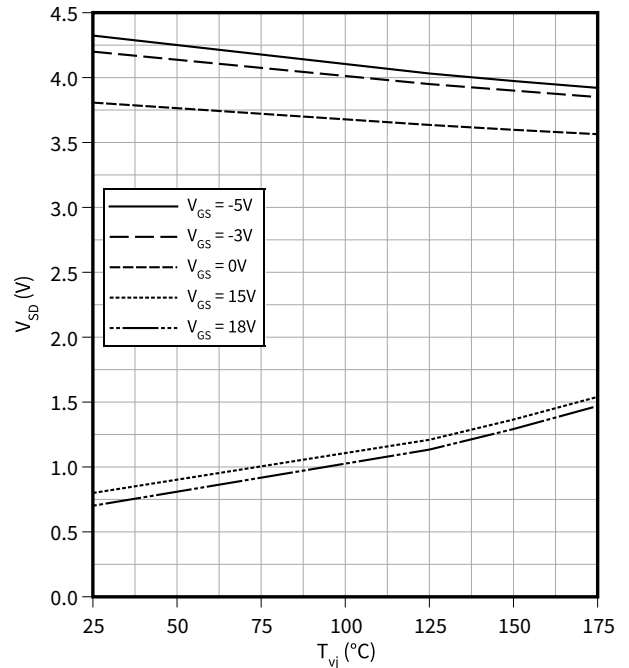



## 5 Circuit diagram

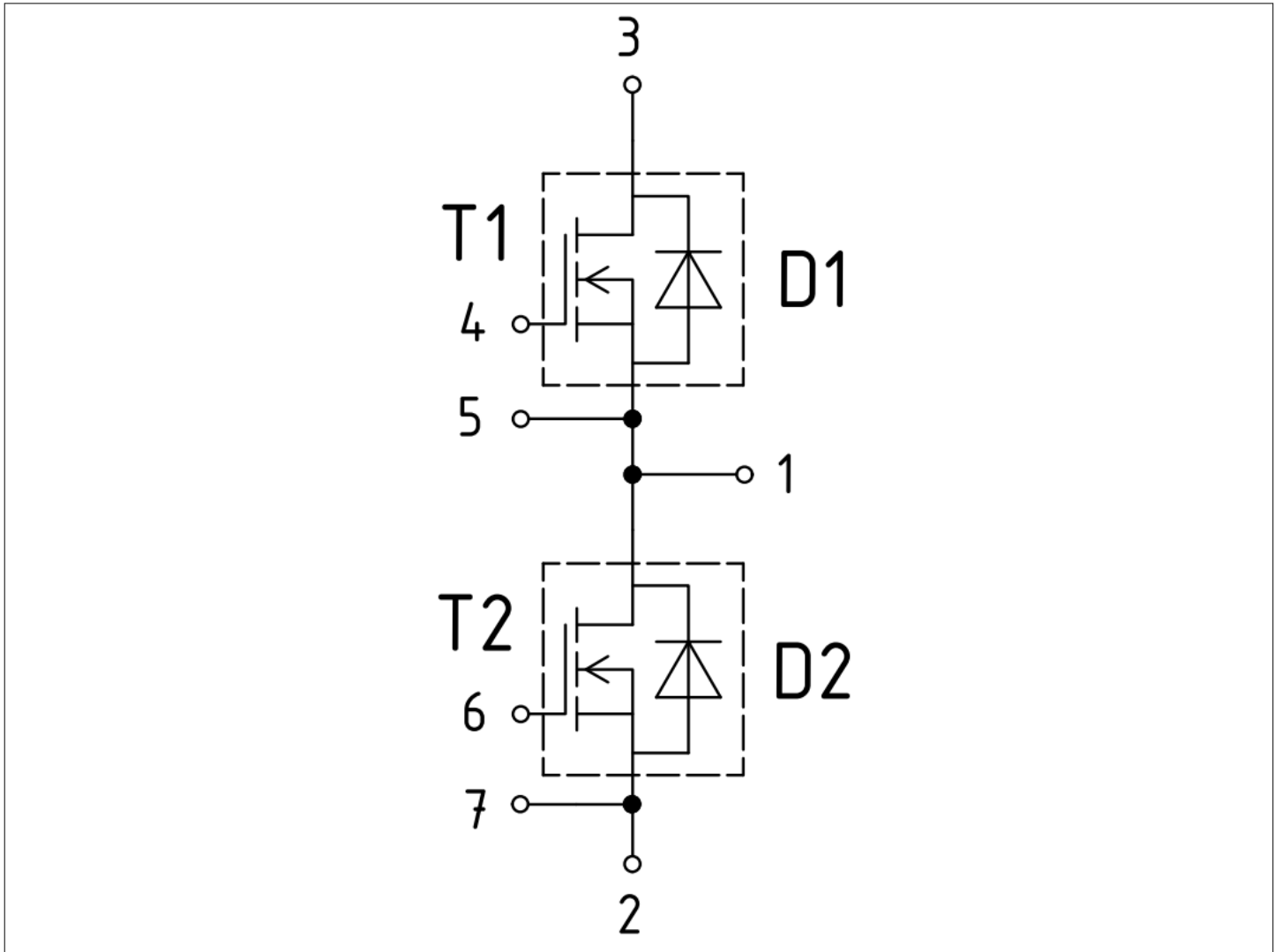
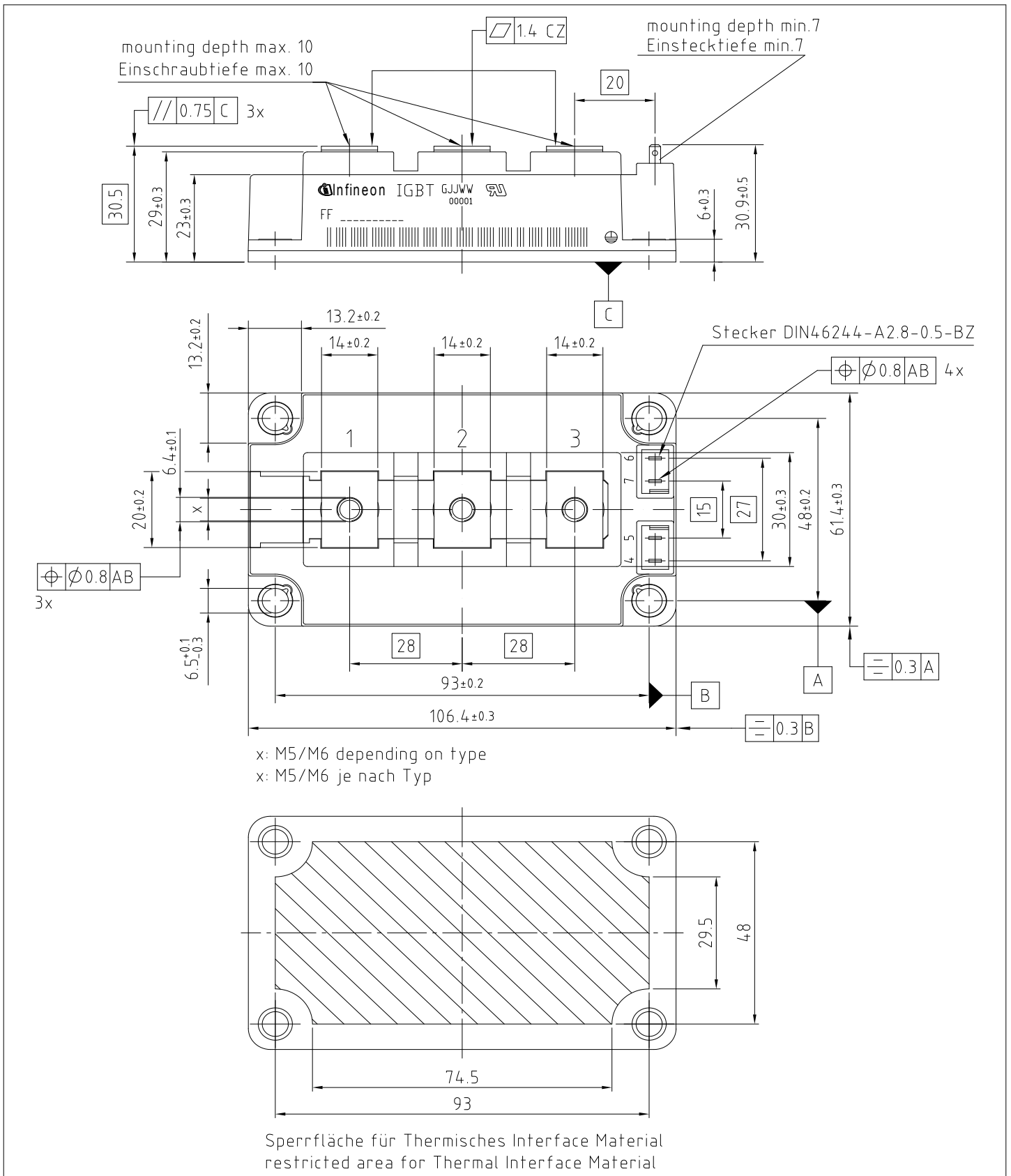



Figure 1

**6 Package outlines**



**Figure 2**

## 7 Module label code

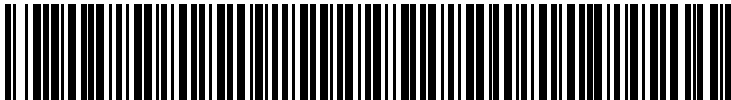
Module label code			
Code format	Data Matrix	Barcode Code128	
Encoding	ASCII text	Code Set A	
Symbol size	16x16	23 digits	
Standard	IEC24720 and IEC16022	IEC8859-1	
Code content	<i>Content</i>	<i>Digit</i>	<i>Example</i>
	Module serial number	1 - 5	71549
	Module material number	6 - 11	142846
	Production order number	12 - 19	55054991
	Date code (production year)	20 - 21	15
	Date code (production week)	22 - 23	30
Example	 		
	71549142846550549911530		71549142846550549911530

**Figure 3**

## Revision history

Document revision	Date of release	Description of changes
0.10	2023-10-18	Initial version

## Trademarks

All referenced product or service names and trademarks are the property of their respective owners.

### **Edition 2023-10-18**

#### **Published by**

**Infineon Technologies AG**  
81726 Munich, Germany

© 2023 Infineon Technologies AG  
All Rights Reserved.

**Do you have a question about any aspect of this document?**

**Email:** [erratum@infineon.com](mailto:erratum@infineon.com)

**Document reference**  
**IFX-ABI437-001**

### **Important notice**

The information given in this document shall in no event be regarded as a guarantee of conditions or characteristics ("Beschaffheitsgarantie").

With respect to any examples, hints or any typical values stated herein and/or any information regarding the application of the product, Infineon Technologies hereby disclaims any and all warranties and liabilities of any kind, including without limitation warranties of non-infringement of intellectual property rights of any third party.

In addition, any information given in this document is subject to customer's compliance with its obligations stated in this document and any applicable legal requirements, norms and standards concerning customer's products and any use of the product of Infineon Technologies in customer's applications.

The data contained in this document is exclusively intended for technically trained staff. It is the responsibility of customer's technical departments to evaluate the suitability of the product for the intended application and the completeness of the product information given in this document with respect to such application.

### **Warnings**

Due to technical requirements products may contain dangerous substances. For information on the types in question please contact your nearest Infineon Technologies office.

Except as otherwise explicitly approved by Infineon Technologies in a written document signed by authorized representatives of Infineon Technologies, Infineon Technologies' products may not be used in any applications where a failure of the product or any consequences of the use thereof can reasonably be expected to result in personal injury.