

EVAL_TDA38813_1VOUT user guide

User guide for TDA38813 evaluation board

About this document

Scope and purpose

The TDA38813 is a synchronous buck regulator, providing a compact, high-performance and flexible solution in a small 3 mm x 4 mm QFN package.

Key features offered by the TDA38813 include internal soft-start, precision 0.9 V reference voltage, Power Good, thermal protection, programmable switching frequency in the range of 600 kHz to 1 MHz, enable input, input undervoltage lockout (UVLO) for proper start-up, latched-off or unlatched overvoltage protection (OVP), overcurrent protection (OCP), and pre-bias start-up.

This user guide contains the schematic and bill of materials for the EVAL_TDA38813_1VOUT engineering evaluation board. It describes operation and use of the evaluation board itself. Detailed application information for TDA38813 is available in the TDA38813 data sheet.

Intended audience

This document is intended as a guide for design engineers evaluating TDA38813 performance with the engineering EVAL_TDA38813_1VOUT demo board.

Important notice

Important notice

“Evaluation Boards and Reference Boards” shall mean products embedded on a printed circuit board (PCB) for demonstration and/or evaluation purposes, which include, without limitation, demonstration, reference and evaluation boards, kits and design (collectively referred to as “Reference Board”).

Environmental conditions have been considered in the design of the Evaluation Boards and Reference Boards provided by Infineon Technologies. The design of the Evaluation Boards and Reference Boards has been tested by Infineon Technologies only as described in this document. The design is not qualified in terms of safety requirements, manufacturing and operation over the entire operating temperature range or lifetime.

The Evaluation Boards and Reference Boards provided by Infineon Technologies are subject to functional testing only under typical load conditions. Evaluation Boards and Reference Boards are not subject to the same procedures as regular products regarding returned material analysis (RMA), process change notification (PCN) and product discontinuation (PD).

Evaluation Boards and Reference Boards are not commercialized products, and are solely intended for evaluation and testing purposes. In particular, they shall not be used for reliability testing or production. The Evaluation Boards and Reference Boards may therefore not comply with CE or similar standards (including but not limited to the EMC Directive 2004/EC/108 and the EMC Act) and may not fulfill other requirements of the country in which they are operated by the customer. The customer shall ensure that all Evaluation Boards and Reference Boards will be handled in a way which is compliant with the relevant requirements and standards of the country in which they are operated.

The Evaluation Boards and Reference Boards as well as the information provided in this document are addressed only to qualified and skilled technical staff, for laboratory usage, and shall be used and managed according to the terms and conditions set forth in this document and in other related documentation supplied with the respective Evaluation Board or Reference Board.

It is the responsibility of the customer’s technical departments to evaluate the suitability of the Evaluation Boards and Reference Boards for the intended application, and to evaluate the completeness and correctness of the information provided in this document with respect to such application.

The customer is obliged to ensure that the use of the Evaluation Boards and Reference Boards does not cause any harm to persons or third party property.

The Evaluation Boards and Reference Boards and any information in this document is provided "as is" and Infineon Technologies disclaims any warranties, express or implied, including but not limited to warranties of non-infringement of third party rights and implied warranties of fitness for any purpose, or for merchantability.

Infineon Technologies shall not be responsible for any damages resulting from the use of the Evaluation Boards and Reference Boards and/or from any information provided in this document. The customer is obliged to defend, indemnify and hold Infineon Technologies harmless from and against any claims or damages arising out of or resulting from any use thereof.

Infineon Technologies reserves the right to modify this document and/or any information provided herein at any time without further notice.

Safety precautions

Safety precautions

Note: Please note the following warnings regarding the hazards associated with development systems

Table 1 Safety precautions



	<p>Caution: The heat sink and device surfaces of the evaluation or reference board may become hot during testing. Hence, necessary precautions are required while handling the board. Failure to comply may cause injury.</p>
	<p>Caution: The evaluation or reference board contains parts and assemblies sensitive to electrostatic discharge (ESD). Electrostatic control precautions are required when installing, testing, servicing or repairing the assembly. Component damage may result if ESD control procedures are not followed. If you are not familiar with electrostatic control procedures, refer to the applicable ESD protection handbooks and guidelines.</p>

Table of contents

About this document.....	1
Important notice	2
Safety precautions.....	3
Table of contents.....	4
1 TDA38813 features	5
2 Board information.....	6
2.1 Evaluation board.....	6
2.2 Board features.....	6
2.3 Connections and operating instructions.....	7
2.4 Layout.....	7
2.5 PCB layout.....	8
2.6 Schematic.....	11
2.7 Bill of materials.....	12
3 Evaluation board test results.....	16
3.1 Typical efficiency and power loss curves	16
3.2 Typical operating waveforms	17
3.3 TDA38813 Thermal images with no air flow and 25°C ambient.....	22
Revision history.....	23

1 TDA38813 features

Features

- Wide input voltage range: 4 V to 16 V with internal bias and 2.7 V to 16 V with external VCC (3.3 V)
- Precision reference voltage (0.9 V \pm 0.5 percent)
- Stable with ceramic output capacitors
- No external compensation
- Optional forced continuous conduction mode and diode emulation for enhanced light load efficiency
- Selectable switching frequency from 600 kHz, 800 kHz, and 1 MHz
- Programmable soft-start time with a minimum of 1.5 ms and enhanced pre-bias start-up
- Voltage tracking with external reference input
- Programmable OCP limit with internal thermal compensation
- Enable input with voltage monitoring capability
- Power Good output
- Latch OCP, undervoltage protection (UVP), thermal shutdown, and latch-off OVP
- Operating temperature: -40 °C less than or equal to $\leq T_J \leq$ less than or equal to 125 °C
- Small size: 3 mm x 4 mm QFN-21
- Lead-free, halogen-free, and RoHS compliant

Potential applications

- Server applications
- Storage applications
- Telecom and datacom applications
- Distributed point-of-load (PoL) power architectures

Board information

2 Board information

2.1 Evaluation board

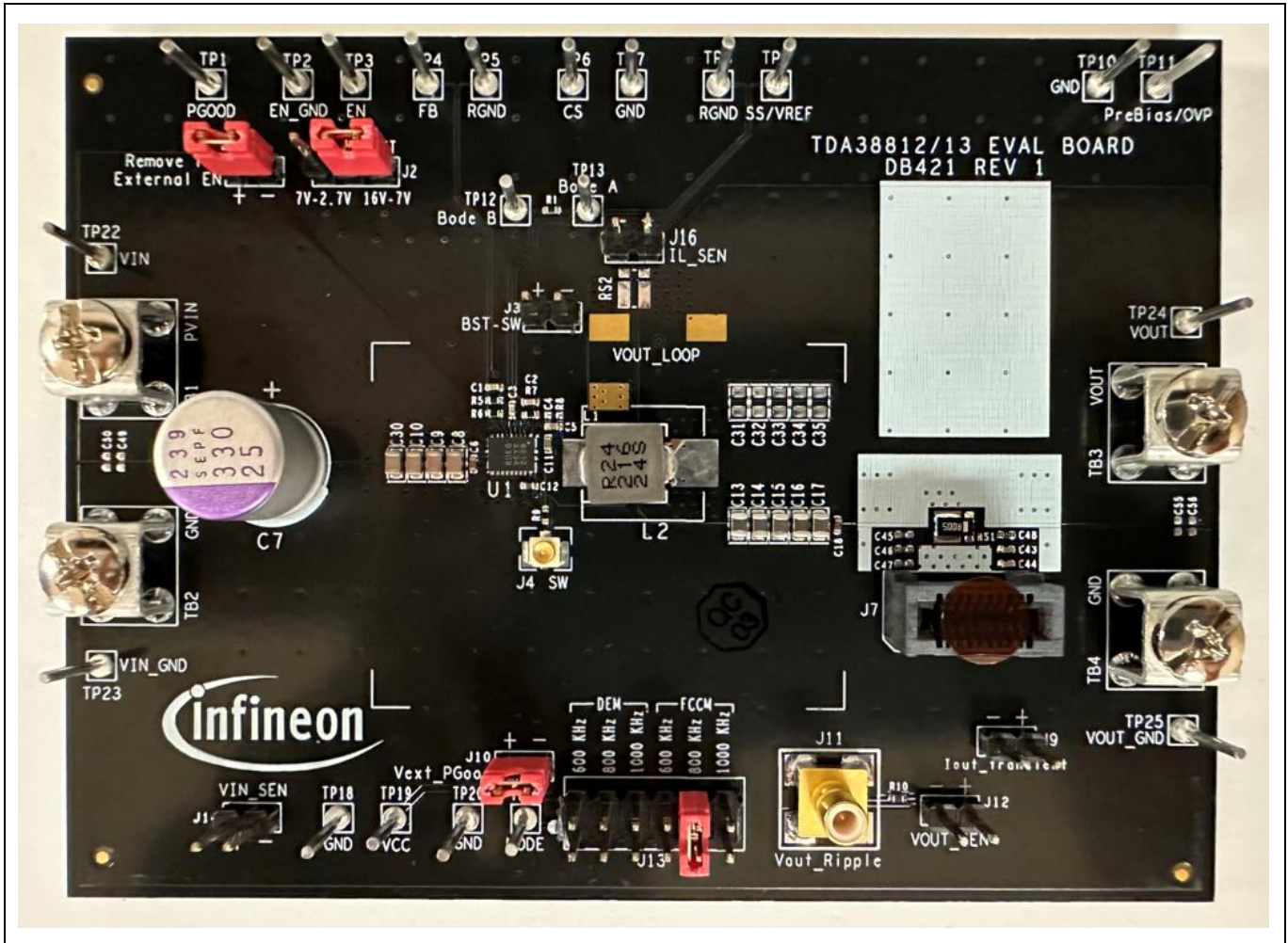

Figure 1 Evaluation board

2.2 Board features

$V_{IN} = +12\text{ V}$, $V_{OUT} = +1\text{ V}$ at 0 to 12 A

$F_s = 600\text{ kHz}/800\text{ kHz}/1000\text{ kHz}$

$L = 240\text{ nH}$

$C_{in} = 10 \times 22\ \mu\text{F}$ (25 V, ceramic 0805) + 2 x 1 μF (25 V, ceramic 0805) + 1 x 330 μF (25 V, electrolytic, optional)

$C_{out} = 10 \times 47\ \mu\text{F}$ (6.3 V, ceramic 0805) + 1 x 2.2 μF (6.3 V, ceramic 0805)

2.3 Connections and operating instructions

The TDA38813 demo board requires a single +12 V for the input power and can deliver up to 12 A load current. The operation modes and OCP limits can be selected through jumpers.

Table 2 Connections

Label		Description
Input	PVIN	Connect input power (+12 V) to this pin
	GND	Return of input power
	PVIN, PGND_SNS	Sense pins for the input voltage
Output	VOUT	V_{OUT} (+1 V), connect a DC load (12 A max.) to this pin
	PGND	Return of V_{OUT}
	VOUT, PGND_SNS	Sense pins for the output voltage
Enable	EN	Connect a scope probe to this pin to monitor enable signal.
	GND	Or, an external enable signal can be applied to this pin to overdrive the on-board enable signal.
Bode	BODE_A	For bode plot measurement
	BODE_B	
Soft-start	SS/VREF	Connect a capacitor to this pin to get different soft-start times
Mode	FCCM	Use a jumper to select FCCM or DEM, and switching frequency. Three preset switching frequencies are: 600 kHz, 800 kHz, 1000 kHz.
	DEM	
CS		Use a resistor to connect to CS to configure the current limit
P _{GOOD}	PGOOD	Connect a scope probe to this pin to monitor Power Good signal
	GND	GND
RGND	RGND	Differential remote sense negative input. Connect this pin directly to the negative side of the voltage sense point. Short to GND if remote sense is not used.
V _{CC}	VCC	Standard demo board is configured to use the internal low-dropout regulator (LDO). Connect a scope probe to this pin to monitor the output of the internal LDO.
	GND	

2.4 Layout

The PCB is a six-layer board using FR4 material. Top and bottom layers use 2 oz. copper and inner layers use 1 oz. copper. The PCB thickness is 1.6 mm. The TDA38813 and other major power components are mounted on the top side of the board.

EVAL_TDA38813_1VOUT user guide

User guide for TDA38813 evaluation board

Board information

2.5 PCB layout

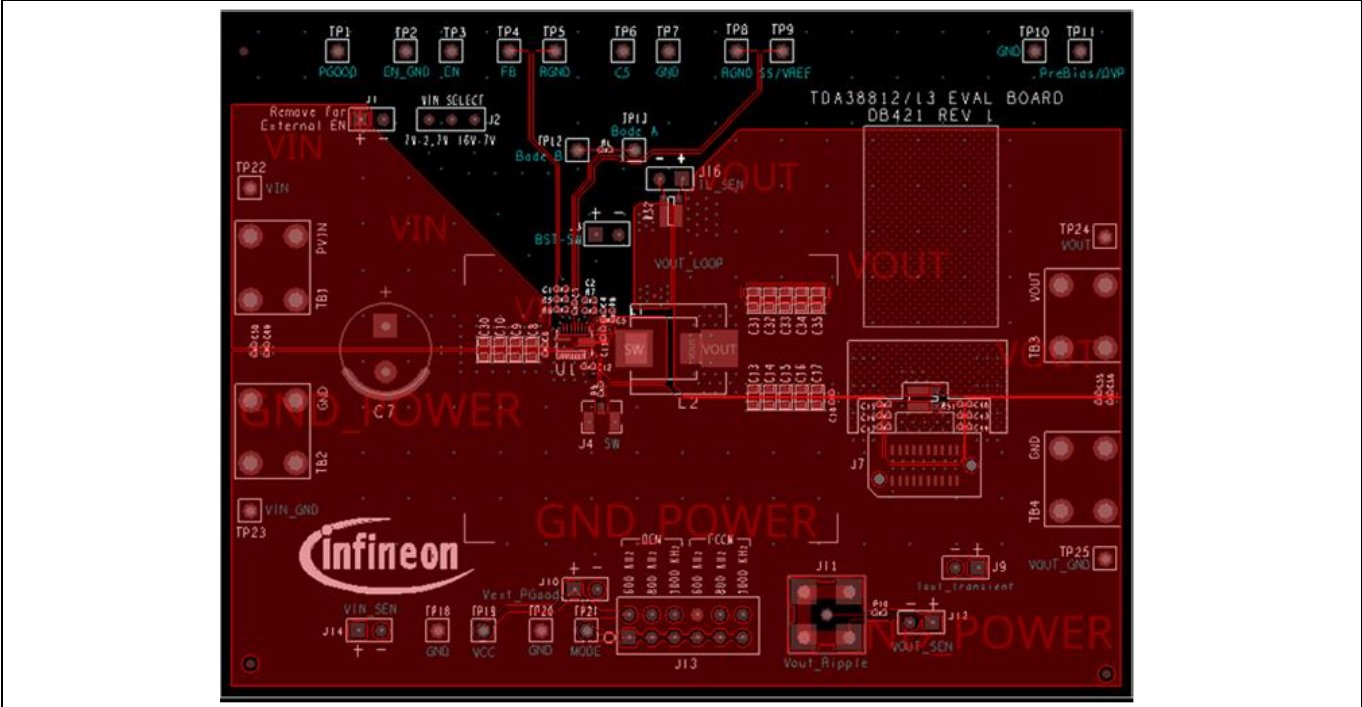

Figure 2 Top layer

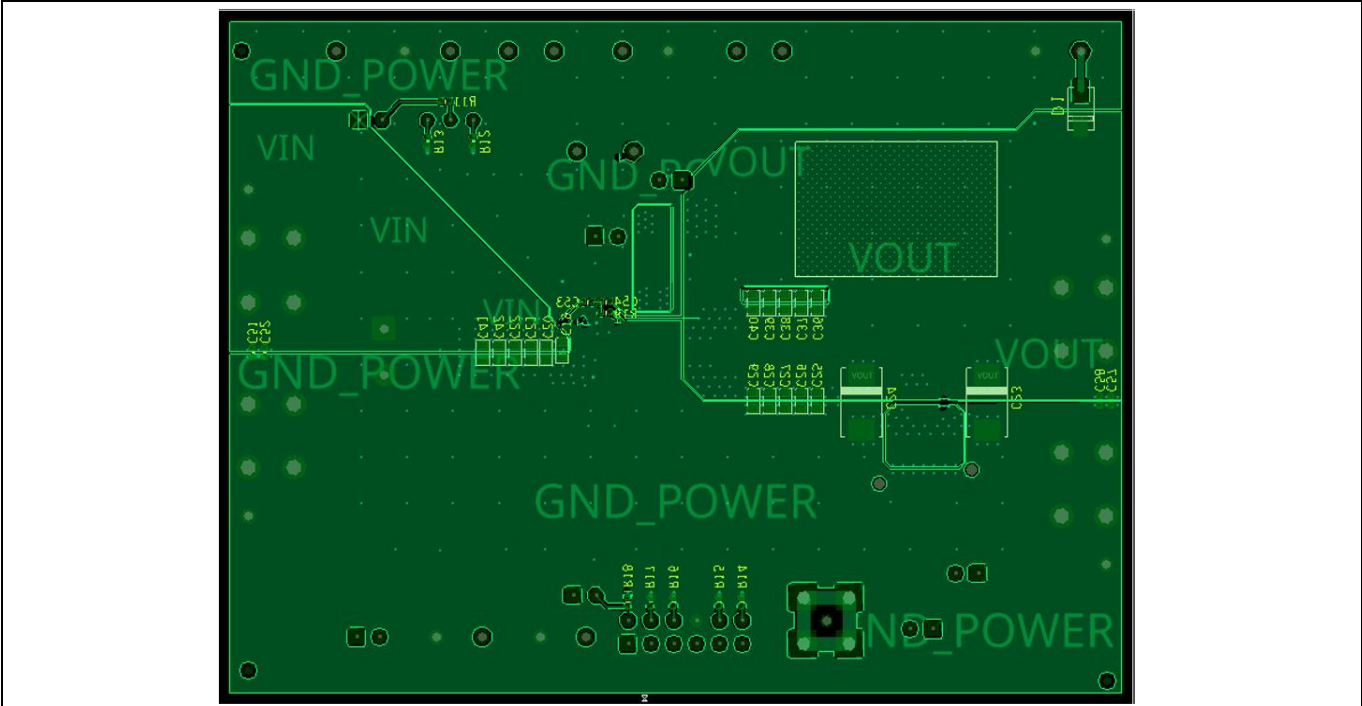

Figure 3 Bottom layer

Board information

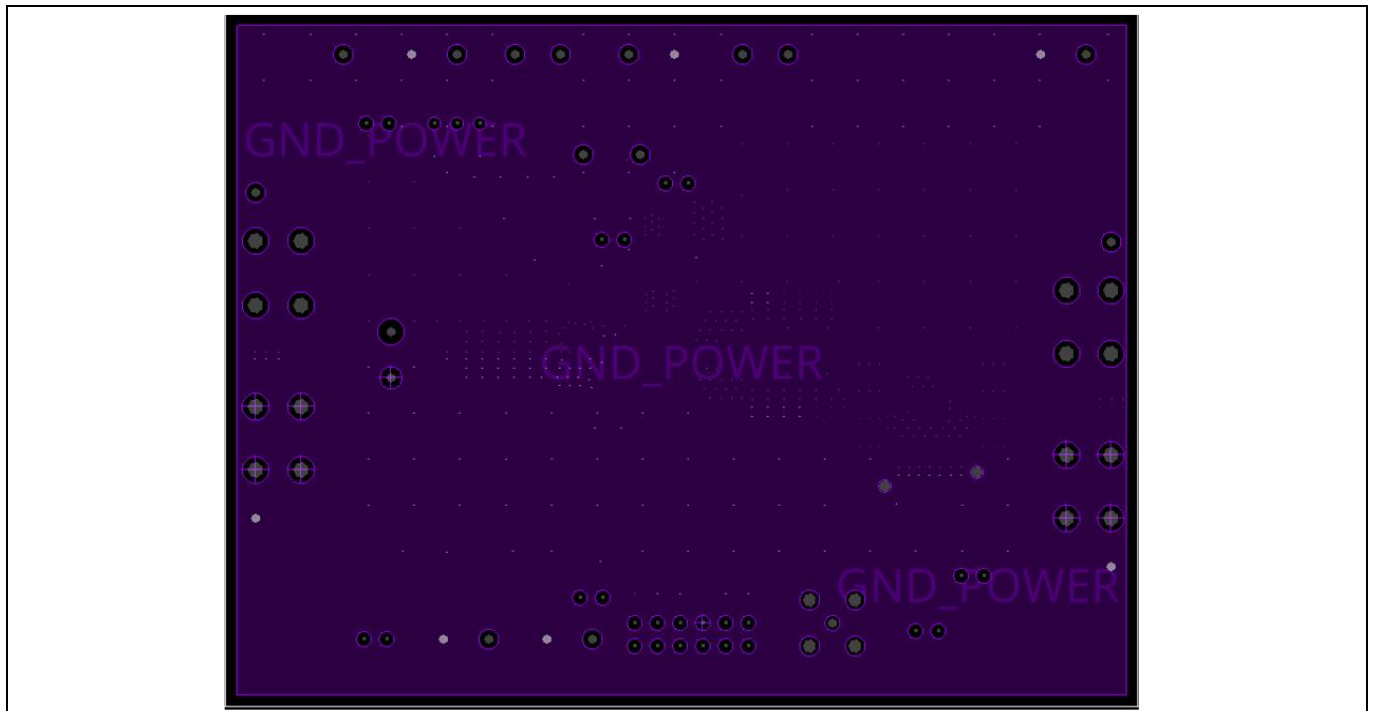

Figure 4 Inner layer 1

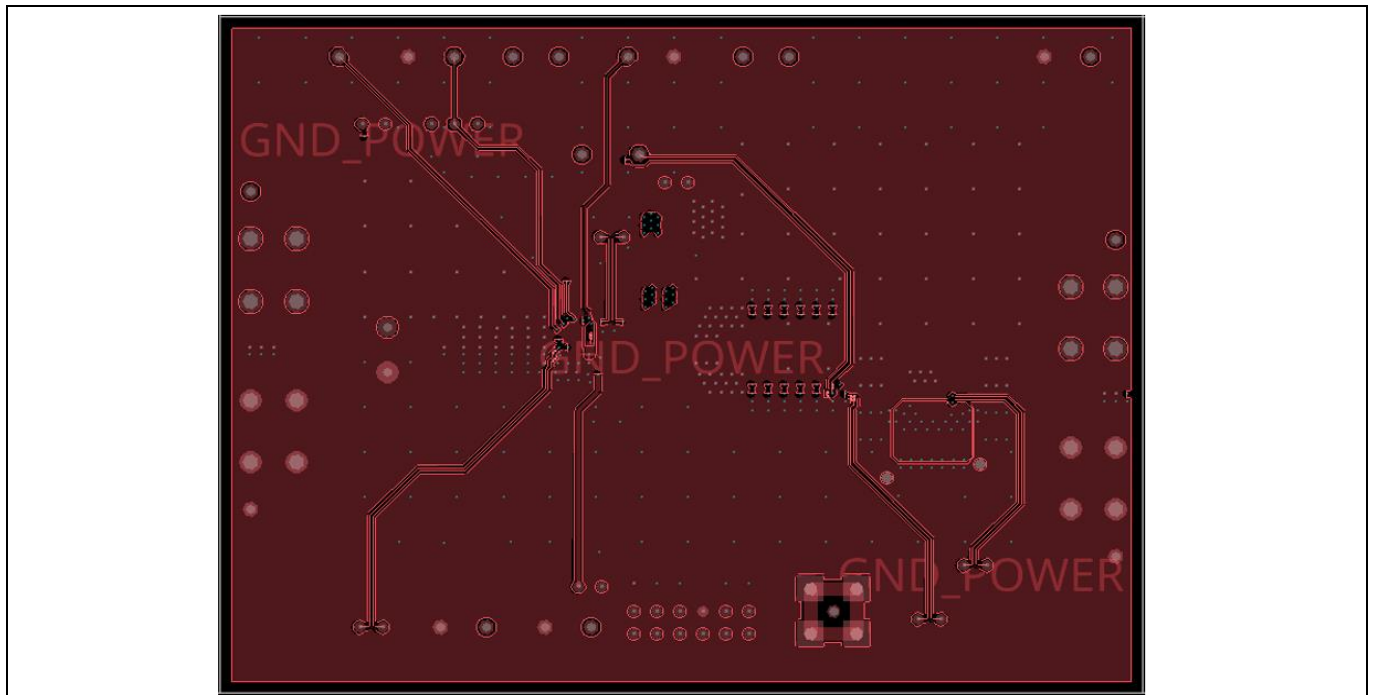

Figure 5 Inner layer 2

Board information

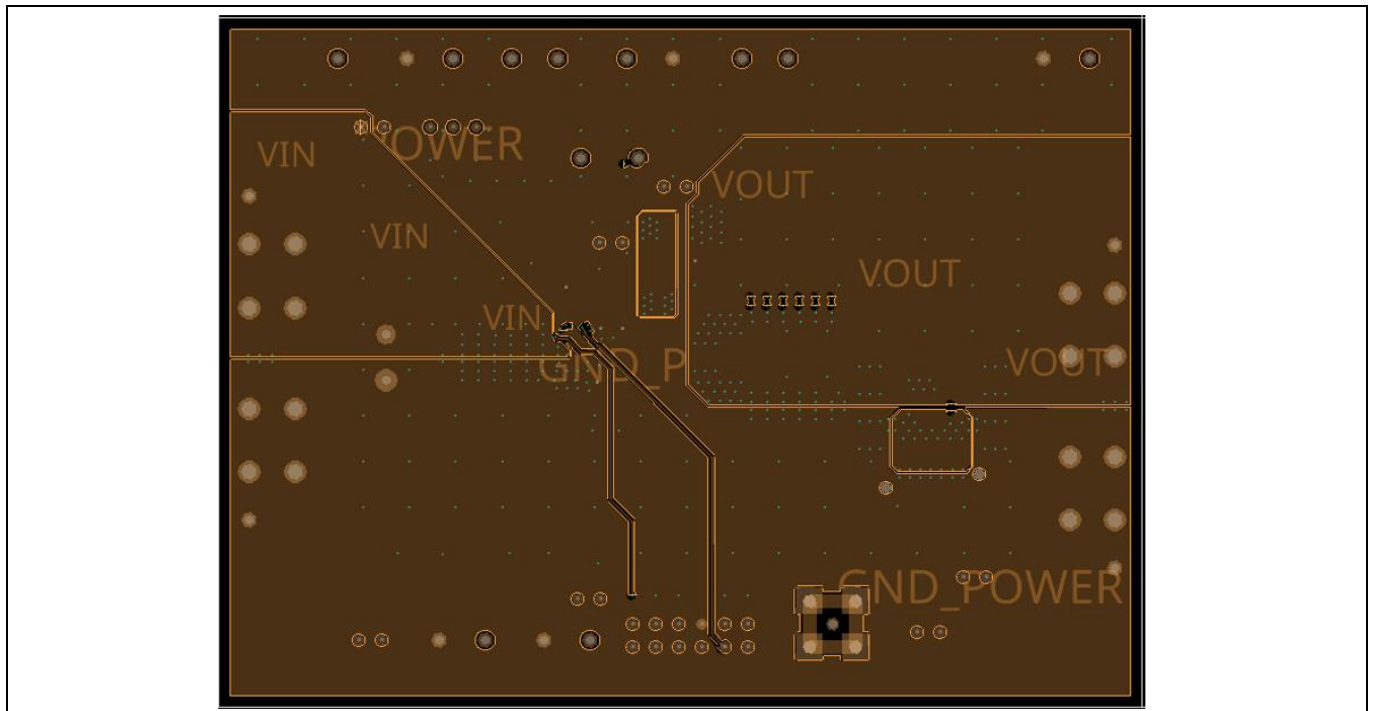

Figure 6 Inner layer 3

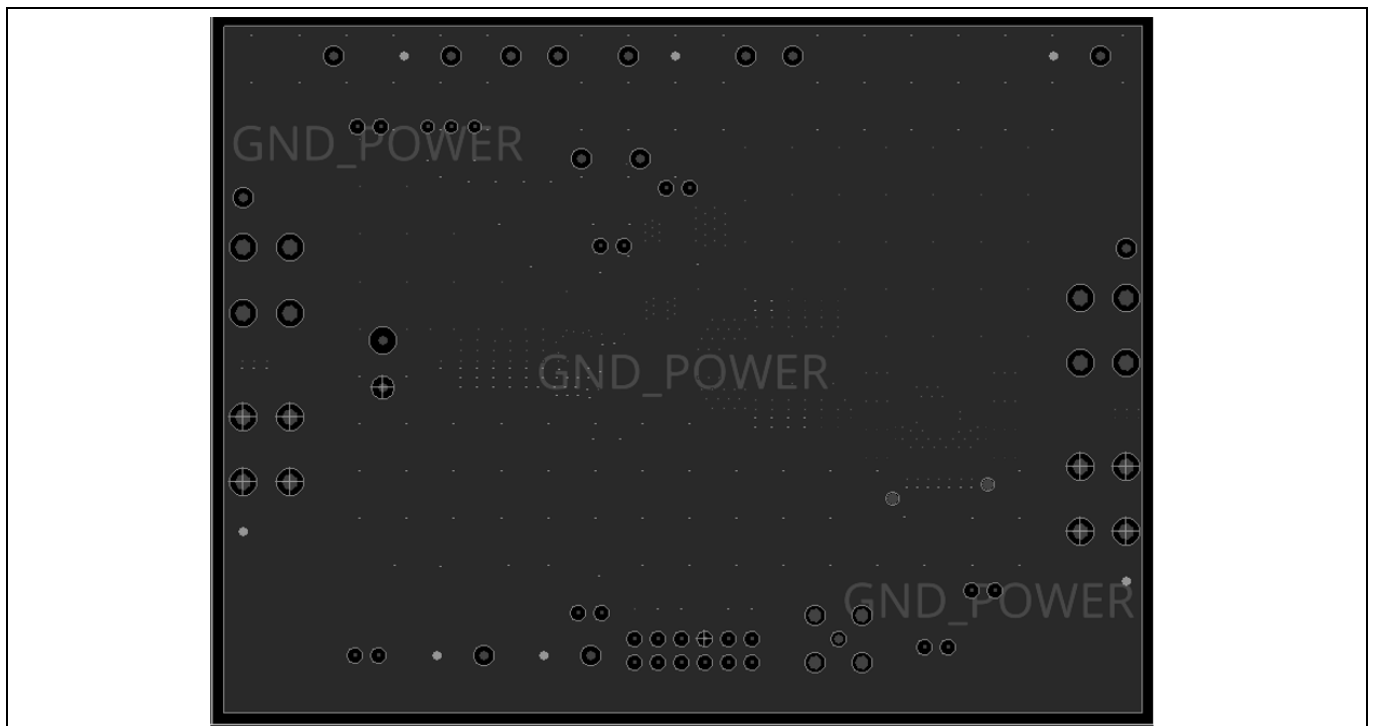

Figure 7 Inner layer 4

Board information

2.6 Schematic

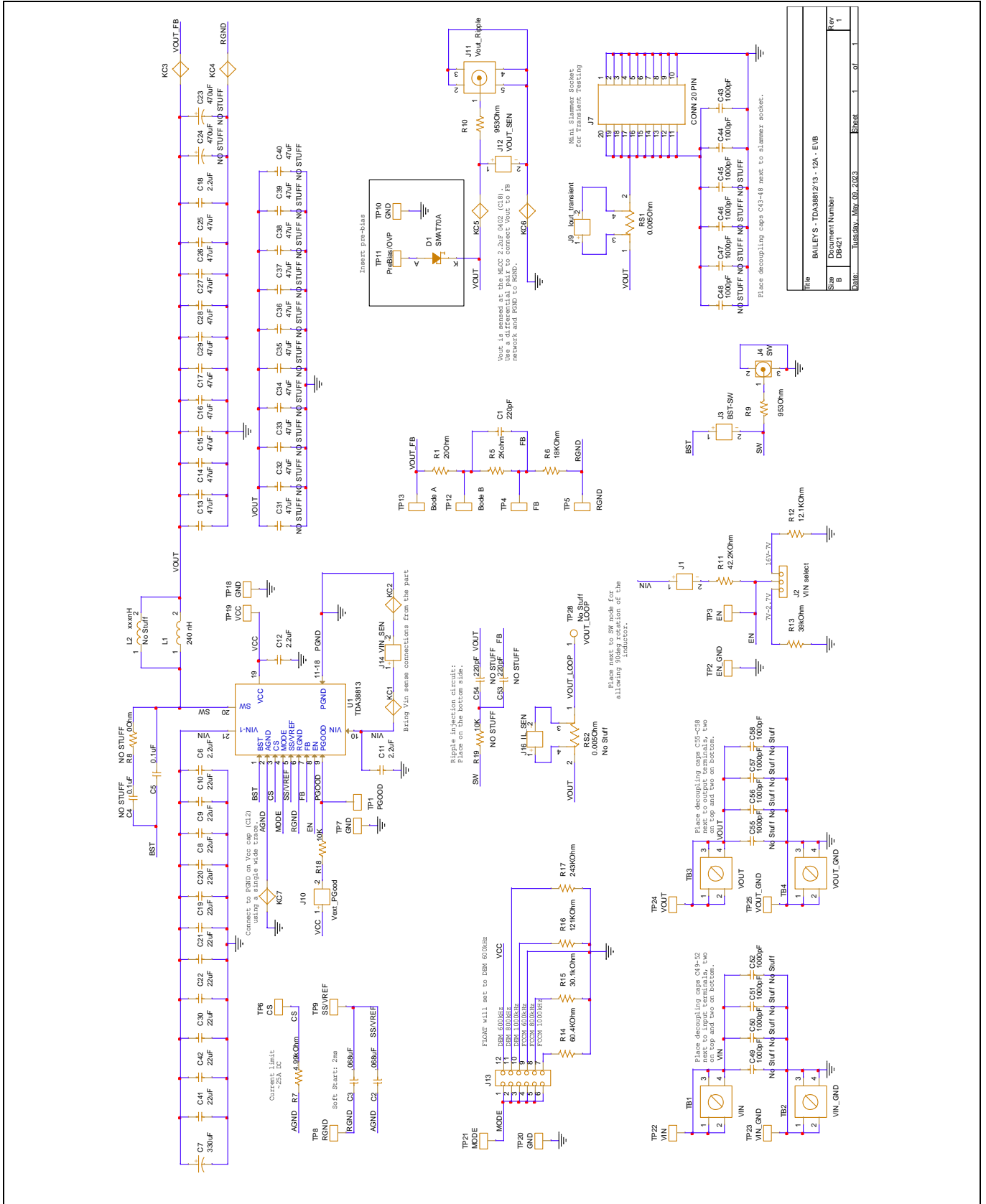

Figure 8 Schematic of the TDA38812 evaluation board $V_{IN} = 12\text{ V}$, $V_{OUT} = 1\text{ V}$, $I_{OUTmax} = 12\text{ A}$

Board information

2.7 Bill of materials

Table 3 Bill of materials

Item no.	Qty	Value	Part reference	Description	Manufacturer	Part number
1	1	220 pF	C1	Ceramic capacitor 220 pF 50 V X7R 0402 10%	TDK Corporation	C1005X7R1H221K050BA
2	1	2.2 μ F	C12	Ceramic capacitor 2.2 μ F 16 V X5R 0402 10%	TDK Corporation	C1005X5R1C225K050BC
3	10	47 μ F	C13, C14, C15, C16, C17, C25, C26, C27, C28, C29	Ceramic capacitor 47 μ F 6.3 V X5R 0805 20%	TDK Corporation	C2012X5R0J476M
4	2	.068 μ F	C2, C3	Ceramic capacitor .068 μ F 16 V X7R 0402 10%	Yageo	CC0402KRX7R7BB683
5	2	1000 pF	C43, C44	Ceramic capacitor 1000 pF 50 V X7R 0402 10%	Kemet	C0402C102K5RAC7867
6	1	0.1 μ F	C5	Ceramic capacitor 0.1 μ F 16 V X7R 0402 10%	Murata	GRM155R71C104KA88D
7	3	2.2 μ F	C6, C11, C18	Ceramic capacitor 2.2 μ F 25 V X5R 0402 10%	Murata	GRM155R61E225KE11D
8	1	330 μ F	C7	Aluminum polyester capacitor 330 μ F 20% 25 V T/H	Panasonic Electronic Components	25SEPF330M
9	10	22 μ F	C8, C9, C10, C19, C20, C21, C22, C30, C41, C42	Ceramic capacitor 22 μ F 25 V X5R 0805 20%	Murata	GRM21BR61E226ME44L

Board information

10	1	SMAT 70 A	D1	TVS Diode 70 VWM 100VC SMA	Diodes Incorporated	SMAT70A-13-F
11	7	-	J1, J3, J9, J10, J12, J14, J16	Vertical header connector 2- position 2.54 MM	Harwin Inc.	M20-9990246
12	1	-	J11	SMB straight jack connector 50 Ω PCB	Cinch Connectivity Solutions/ Johnson	131-3701-261
13	1	-	J13	Vertical header connector 12- position 2.54 MM	Adam Tech	PH2-12-UA
14	1	-	J2	Header connector R/A 3-Position 2.54 MM	Harwin Inc.	M20-9960345
15	1	-	J4	UMCC straight jack connector 50 Ω SMD	TE Connectivity/ AMP Connectors	1909763-1
16	1	20-pin connector	J7	Dual female edge connector 20- position 0.031	Samtec Inc.	HSEC8-110-01-S-DV-A- K-TR
17	1	240 nH	L1	Fixed inductor 240 nH 35 A 1.19 MΩ SMD	Delta Electronics/Cyntec	CMLE063T- R24MS1R197
18	1	20 Ω	R1	Thick film resistor 20.0 Ω 1/16 W 1% SMD 0402	Yageo	RE0402FRE0720RL
19	1	42.2 kΩ	R11	Thick film resistor 42.2 kΩ 1/16 W 1% 0402	Yageo	RC0402FR-0742K2L
20	1	12.1 kΩ	R12	Thick film resistor 12.1 kΩ 1/10 W 1% 0402	Panasonic	ERJ-2RKF1212X
21	1	39 kΩ	R13	Thick film resistor 39 kΩ 5.0 % 1/16 W SMD 0402	Panasonic	ERJ-2GEJ393X

Board information

22	1	60.4 k Ω	R14	Thick film resistor 60.4 k Ω 1/10 W 1% 0402	Yageo	RC0402FR-0760K4L
23	1	30.1 k Ω	R15	Thick film resistor 30.1 k Ω 1.0 % 1/16 W SMD 0402	Vishay	CRCW040230K1FKED
24	1	121 k Ω	R16	Thick film resistor 121 k Ω 1/10 W 1% 0402	Yageo	RC0402FR-07121KL
25	1	243 k Ω	R17	Thick film resistor 243 k Ω 1/16 W 1% 0402	Yageo	RC0402FR-07243KL
26	1	10 K	R18	SMD resistor 10 k Ω 1% 1/16 W 0402	Yageo	AC0402FR-0710KL
27	1	2 K	R5	SMD resistor 2 k Ω 1% 1/16 W 0402	Yageo	AC0402FR-072KL
28	1	18 k Ω	R6	Thick film resistor 18.0 k Ω 1/16 W 1% 0402	Yageo	AC0402FR-0718KL
29	1	4.99 k Ω	R7	Thick film resistor 4.99 k Ω 1/16 W 1% 0402	Yageo	RC0402FR-074K99L
30	2	953 Ω	R9, R10	Thick film resistor 953 Ω 1/10 W 1% 0402	Yageo	RC0402FR-07953RL
31	1	0.005 Ω	RS1	Thick film resistor 0.005 Ω 1 W 1% SMD 1632	Delta Electronics	RL1632T4F-R005-FNH
32	4	-	TB1, TB2, TB3, TB4,	Terminal screw 6- 32 4-pinPCB	Keystone Electronics	7693

Board information

33	21	-	TP1, TP2, TP3, TP4, TP5, TP6, TP7, TP8, TP9, TP10, TP11, TP12, TP13, TP18, TP19, TP20, TP21, TP22, TP23, TP24, TP25	Inboar” pin .042” hole 1000/PKG	Vector Electronics	K30C/M
34	1	TDA38813	U1	TDA38813 12 A single-voltage synchronous buck regulator	Infineon	TDA38813

Evaluation board test results

3 Evaluation board test results

3.1 Typical efficiency and power loss curves

$V_{IN} = 12\text{ V}$, $V_{CC} = \text{internal LDO}$, $I_{OUT} = 0\text{ A} - 12\text{ A}$, $F_{SW} = 800\text{ kHz}$, room temperature, natural convection. Note that the efficiency and power loss curves include losses of the TDA38813, inductor losses, losses of the input and output capacitors, and PCB trace losses. [Error! Reference source not found.](#) shows the inductors used for each of the output voltages in the efficiency measurement.

Table 4 Inductors for $V_{IN} = 12\text{ V}$, $F_{SW} = 800\text{ kHz}$

V_{OUT} (V)	L_{OUT} (nH)	P/N	DCR (m Ω)	Size (mm)
1.0	240 nH	CMLE063T-R24MS	1.19	6.95 x 6.6 x 2.8
3.3	820 nH	CMLE063T-R82MS	4.7	7.25 x 6.6 x 2.8
5.0	1000 nH	CMLE063T-1R0MS	5.6	7.25 x 6.6 x 2.8

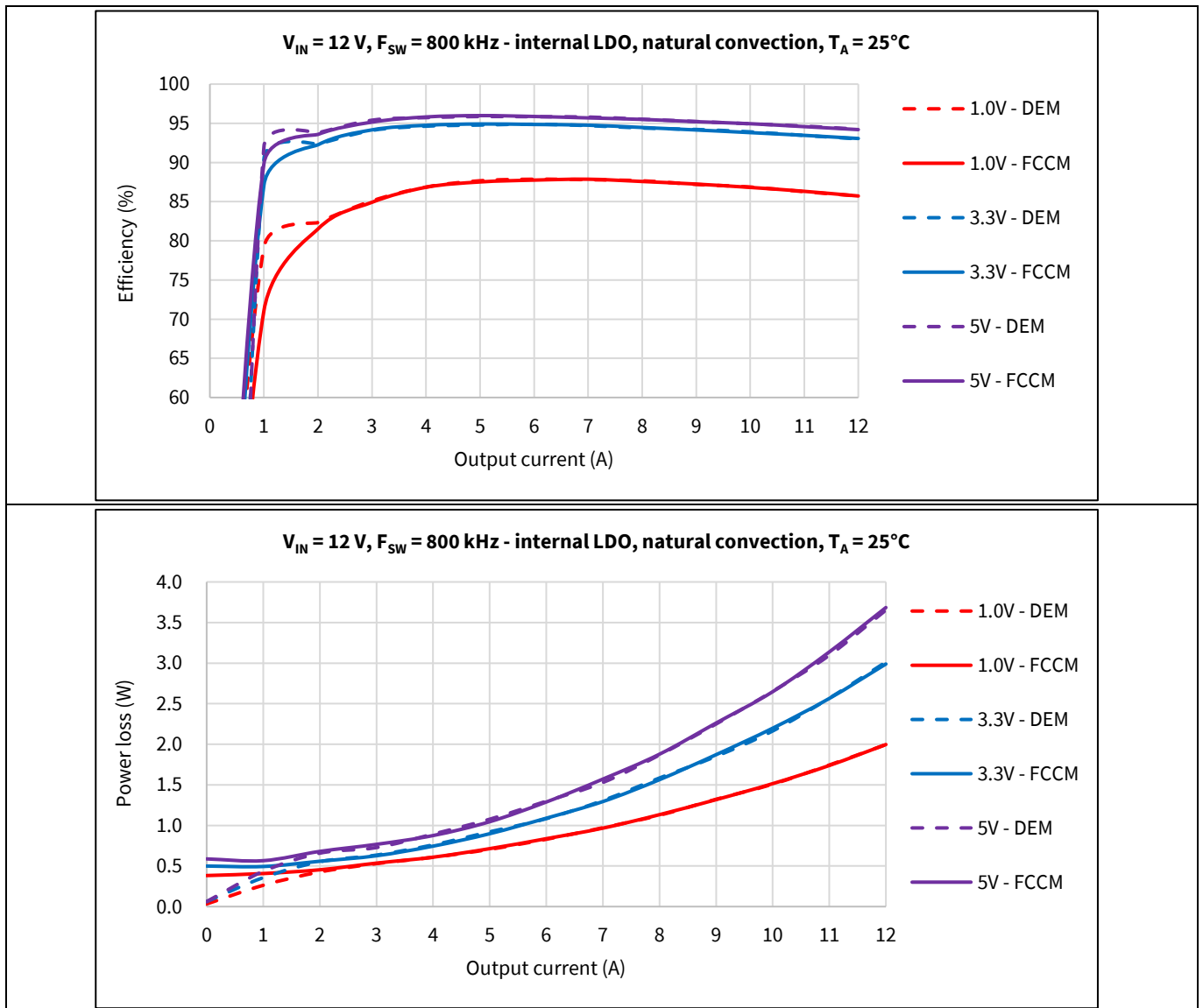

Figure 9 Efficiency and power loss

Evaluation board test results

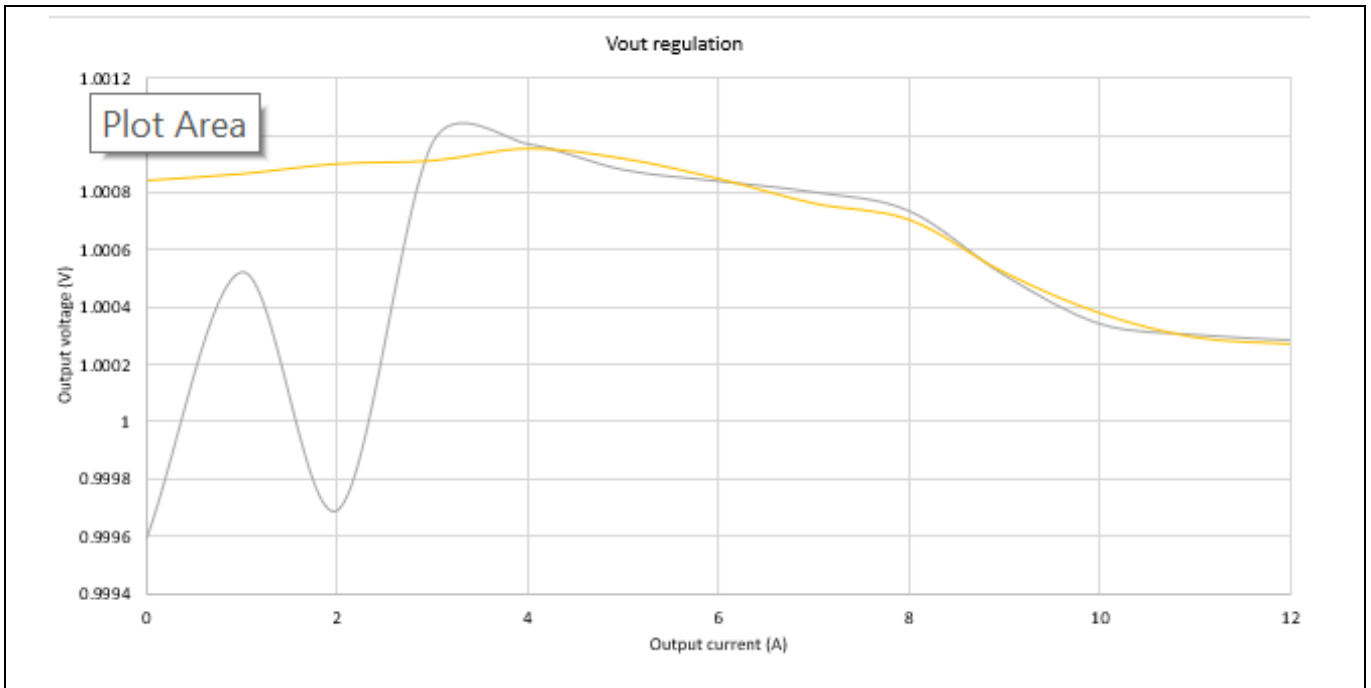

Figure 10 Output voltage regulation

3.2 Typical operating waveforms

$V_{IN} = V_{IN} = 12.0\text{ V}$, $V_{OUT} = 1\text{ V}$, $I_{OUT} = 12\text{ A}$, $F_{SW} = 800\text{ kHz}$, room temperature, no airflow

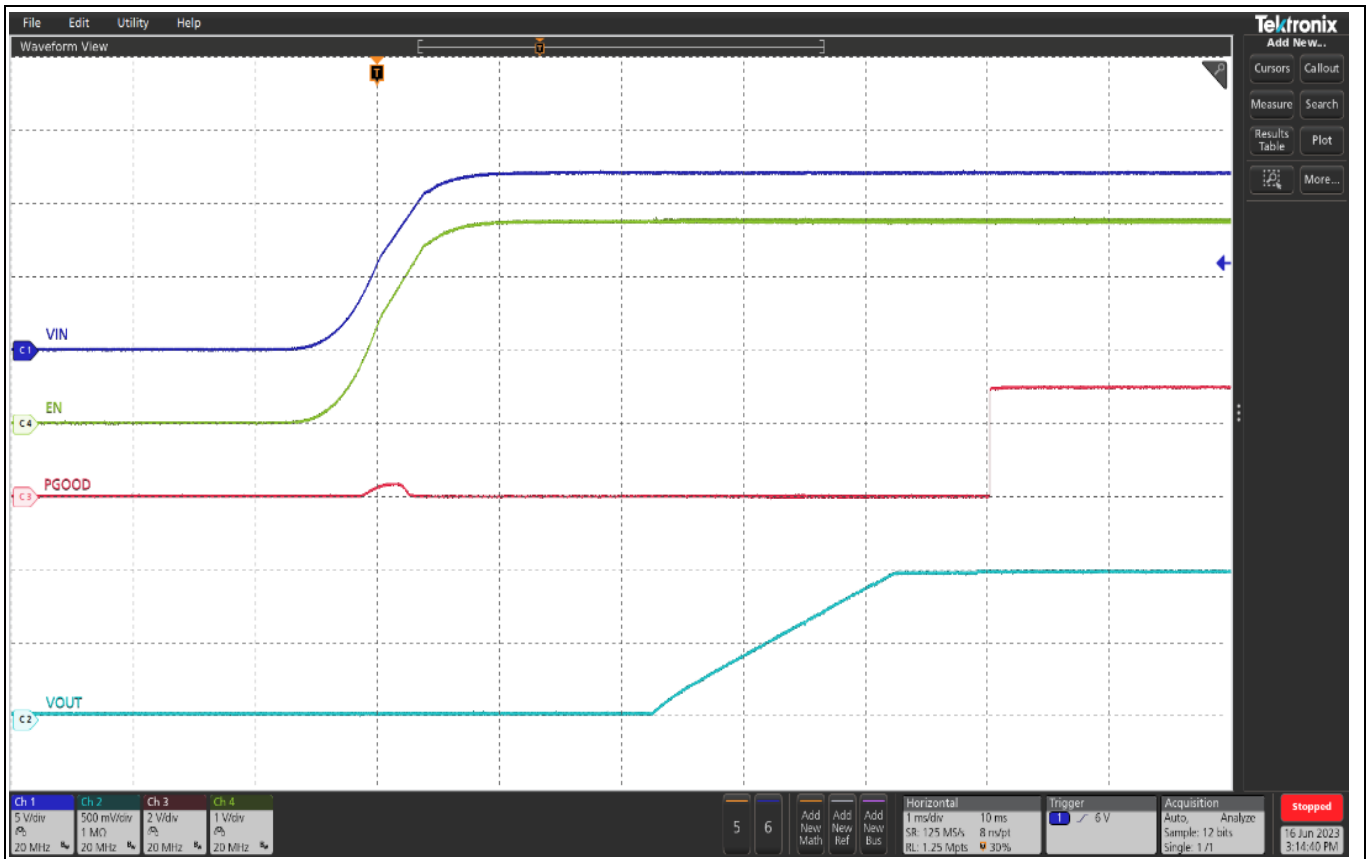

Figure 11 Start-up at 12 A load, (Ch1: V_{IN} , Ch2: V_{OUT} , Ch3: P_{GOOD} , Ch4: enable)

EVAL_TDA38813_1VOUT user guide

User guide for TDA38813 evaluation board

Evaluation board test results

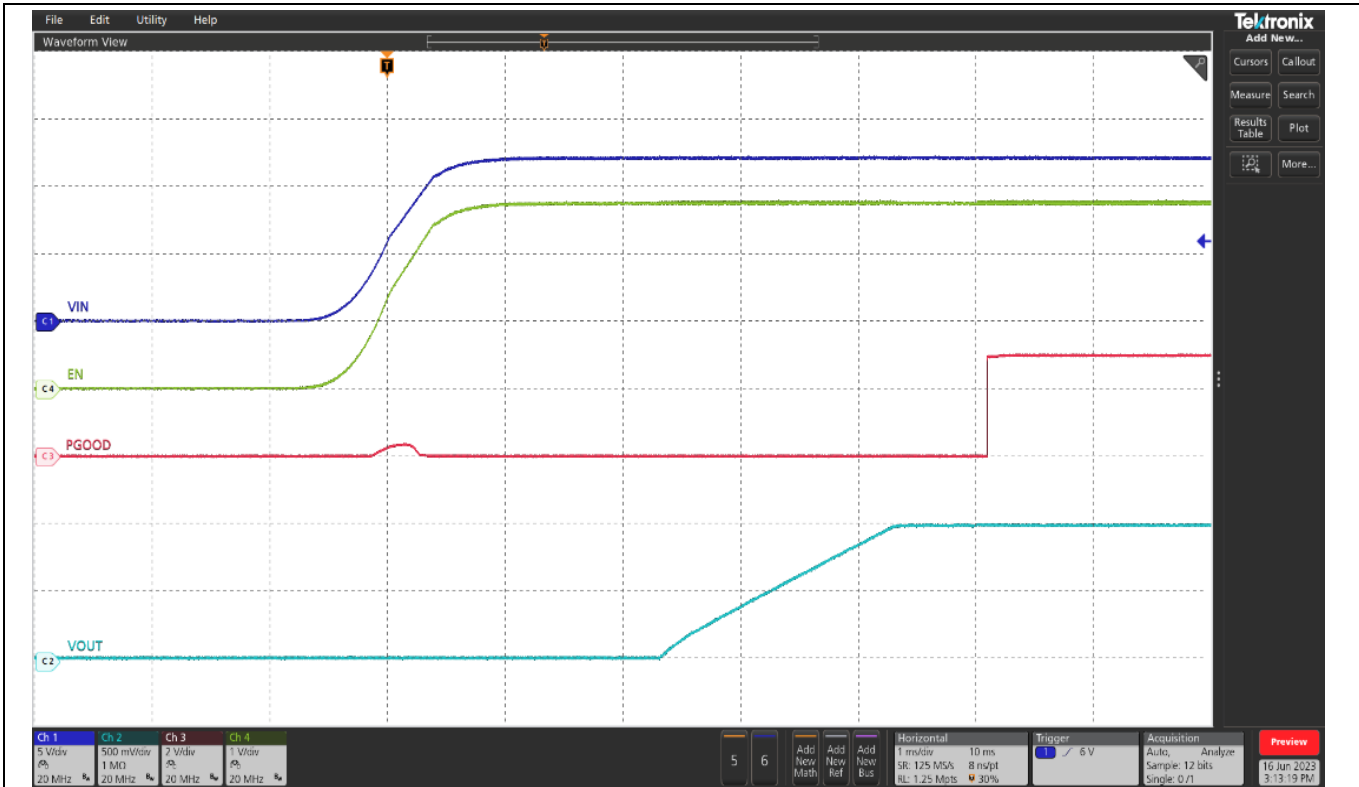

Figure 12 Pre-bias start-up at 0 A load, (Ch1: V_{IN}, Ch2: V_{OUT}, Ch3: P_{GOOD}, Ch4: enable)

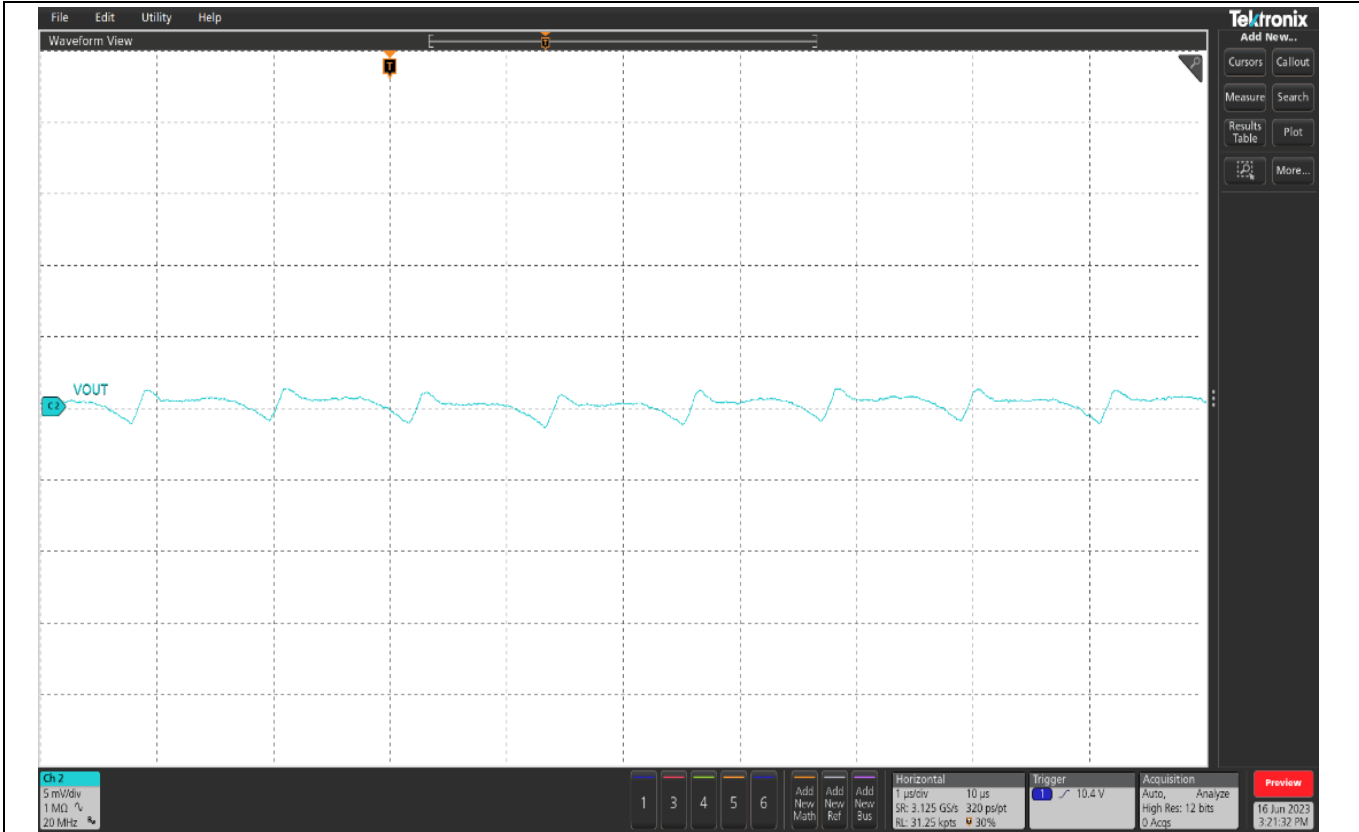

Figure 13 V_{OUT} ripple at 12 A load, F_{sw} = 800 kHz, (Ch2: V_{OUT})

EVAL_TDA38813_1VOUT user guide

User guide for TDA38813 evaluation board

Evaluation board test results

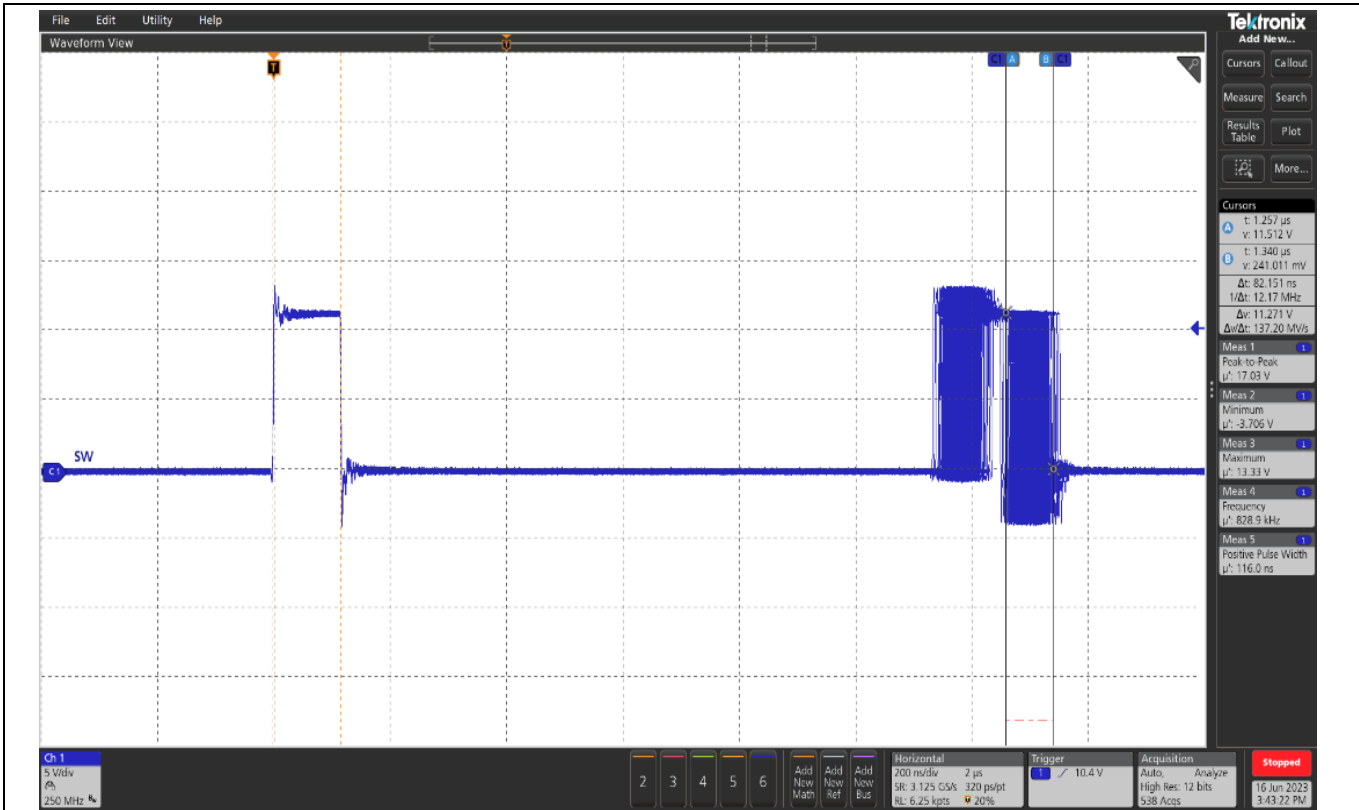

Figure 14 SW node, 12 A load, $F_{sw} = 800$ kHz

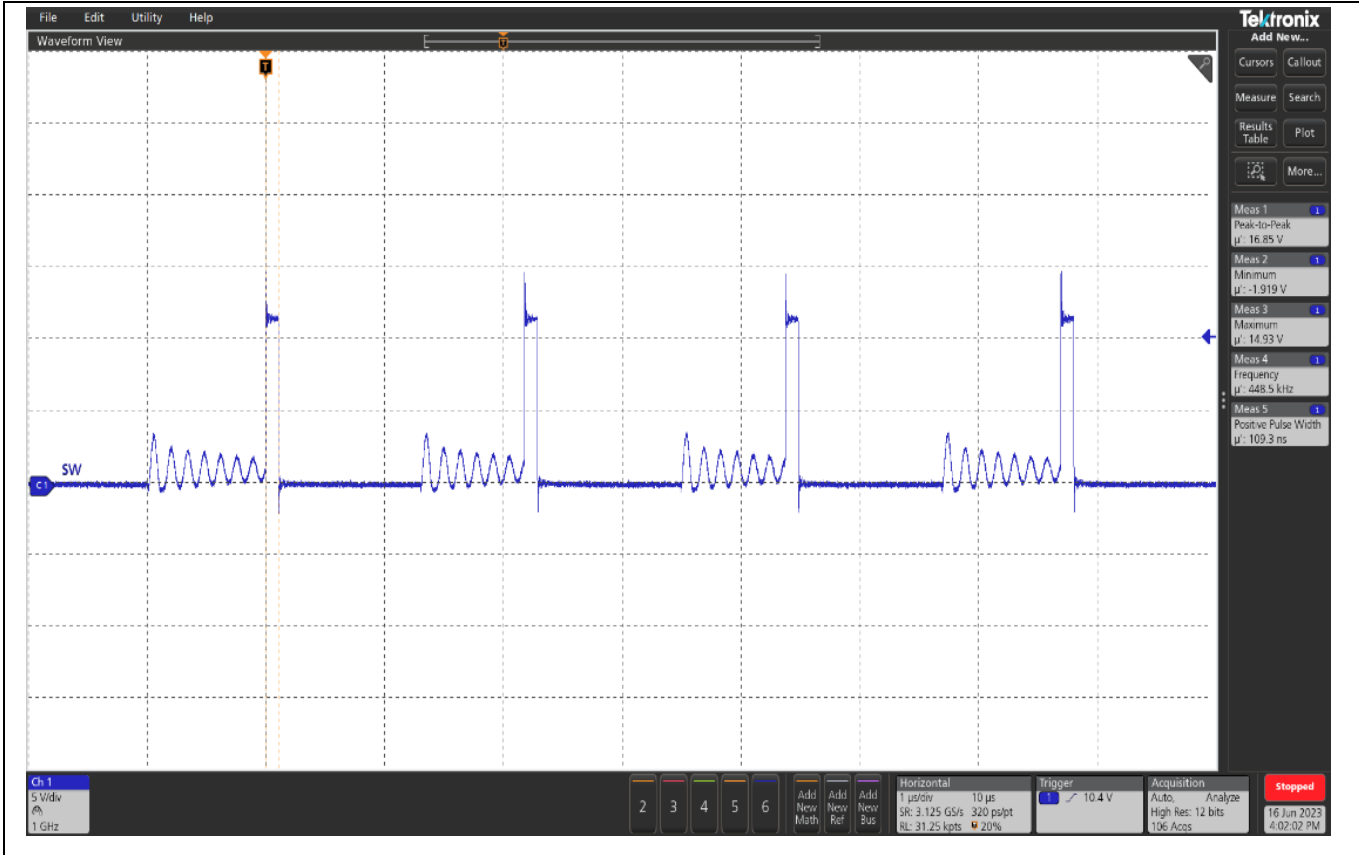

Figure 15 SW node (in DEM), 1 A load

EVAL_TDA38813_1VOUT user guide

User guide for TDA38813 evaluation board

Evaluation board test results

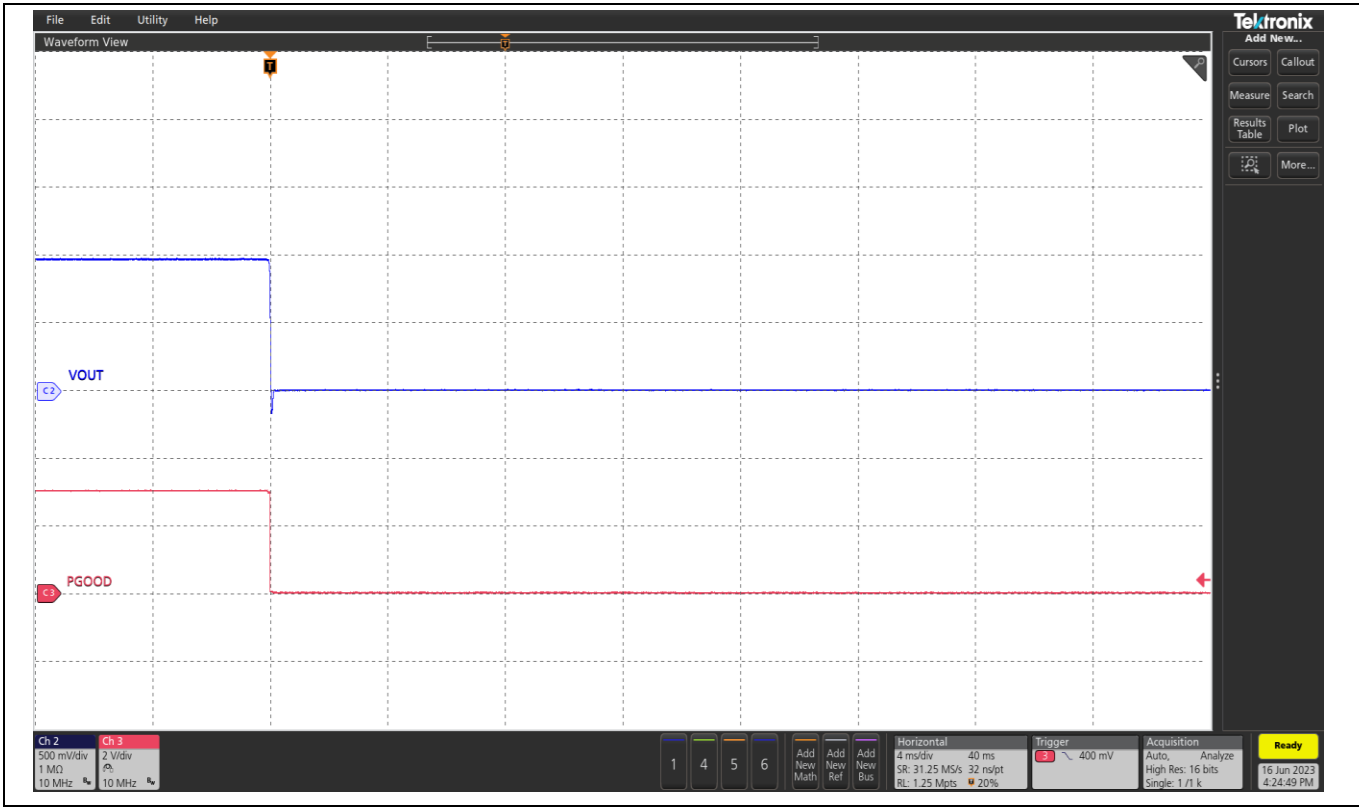

Figure 16 Short circuit and UVP (shutdown), (Ch2: V_{OUT}, Ch3:P_{GOOD})

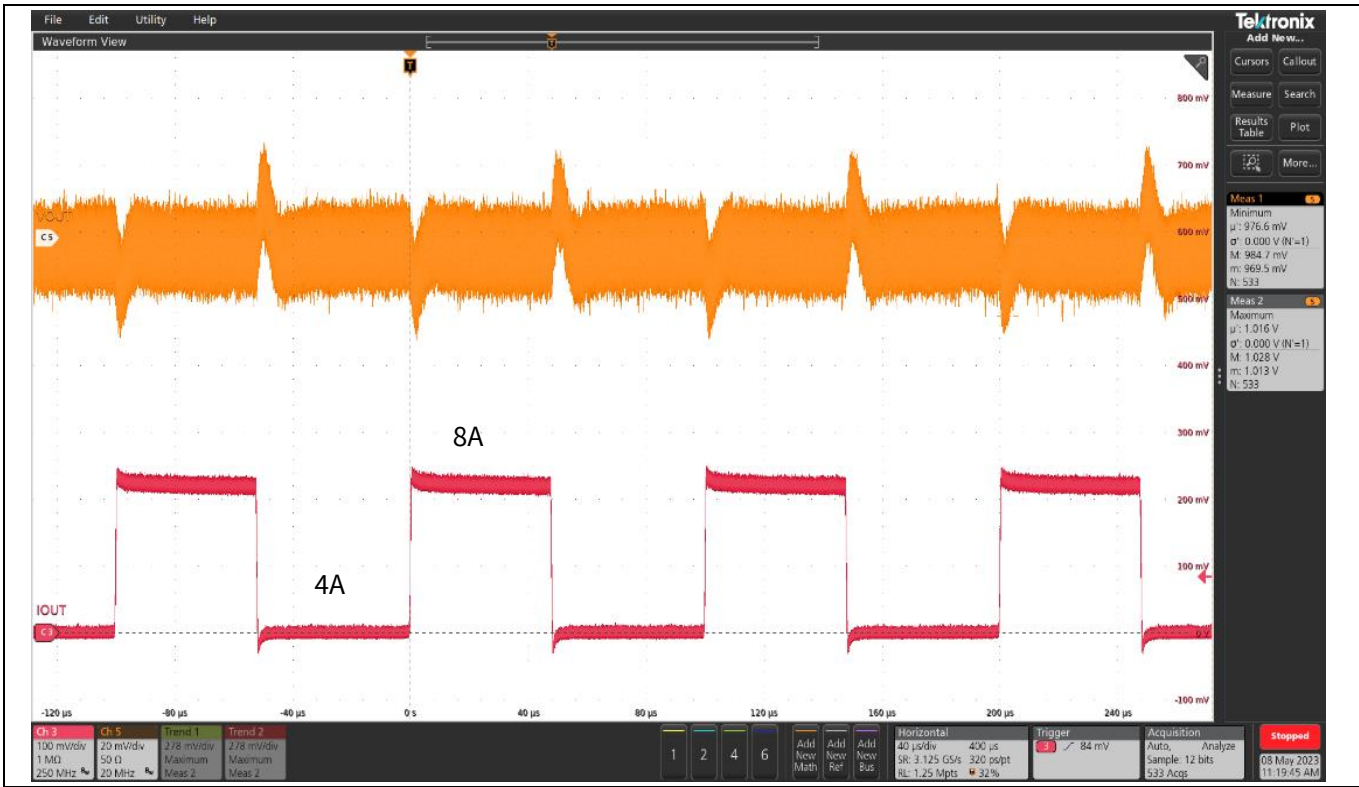

Figure 17 Transient response at 4 A step load current at 10 A/μs slew rate: I_{OUT}= 4 A – 8 A, (Ch5: V_{OUT}, Ch3: I_{OUT}), pk-pk: 39.4mV, F_{SW} = 800 kHz

Evaluation board test results

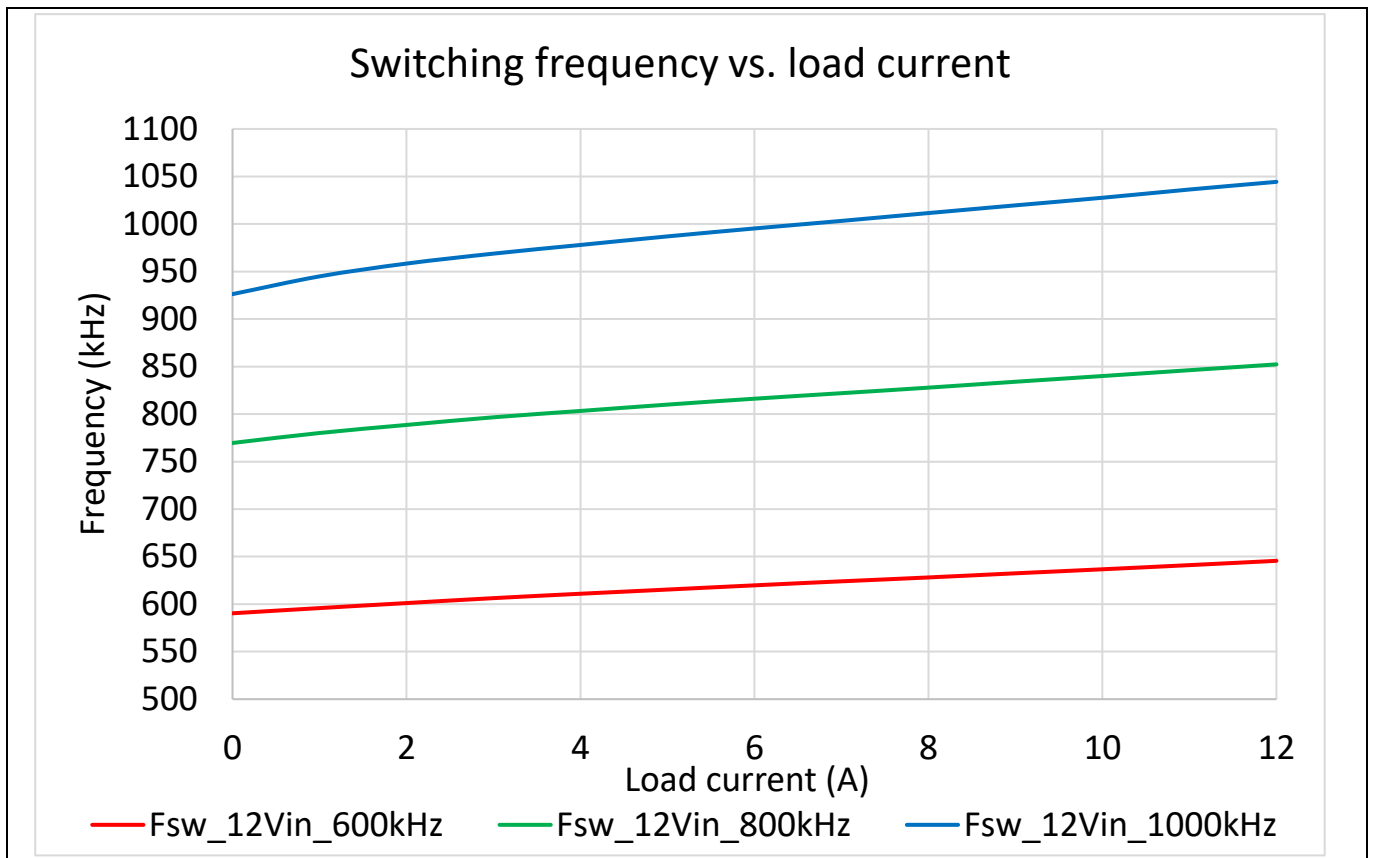

Figure 18 Switching frequency vs. load current

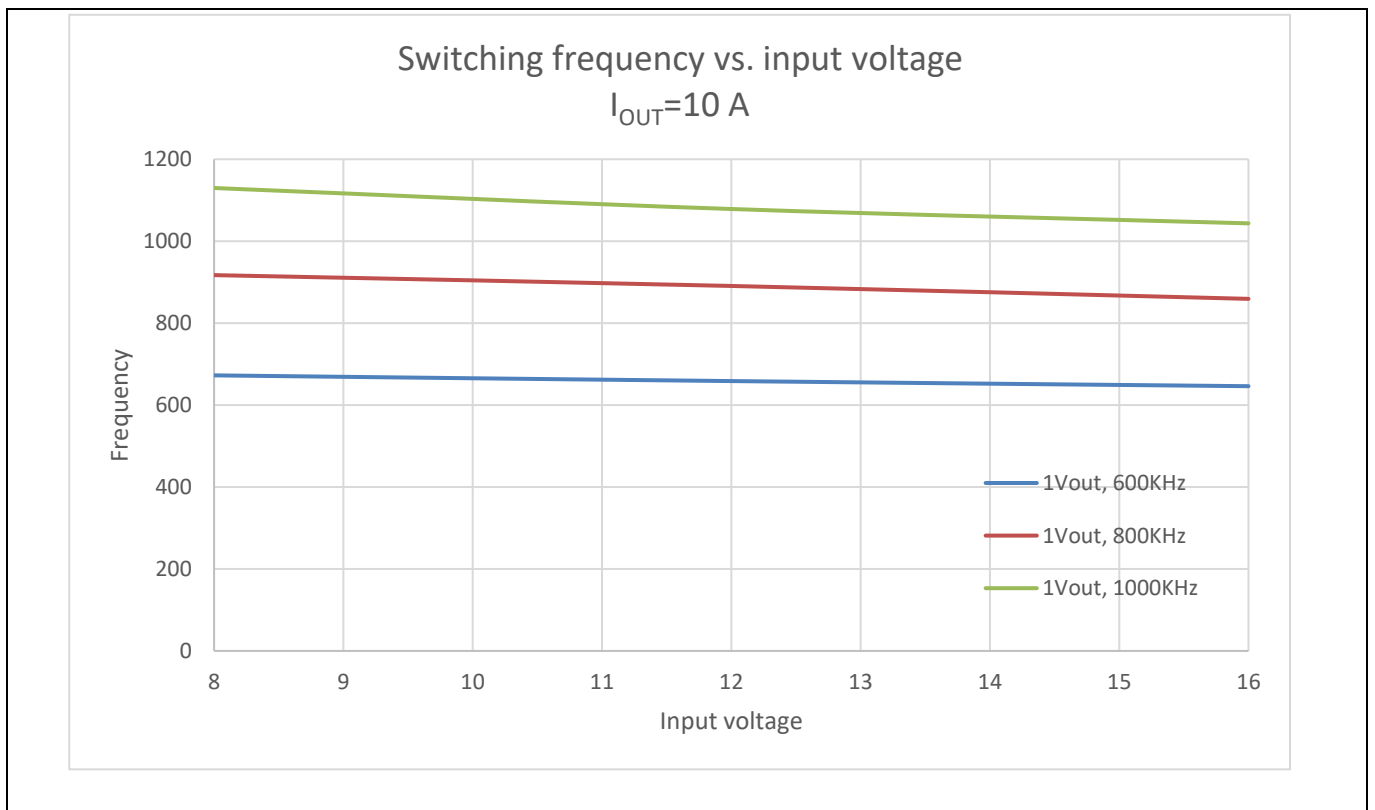

Figure 19 Switching frequency vs. input voltage

3.3 TDA38813 Thermal images with no air flow and 25°C ambient

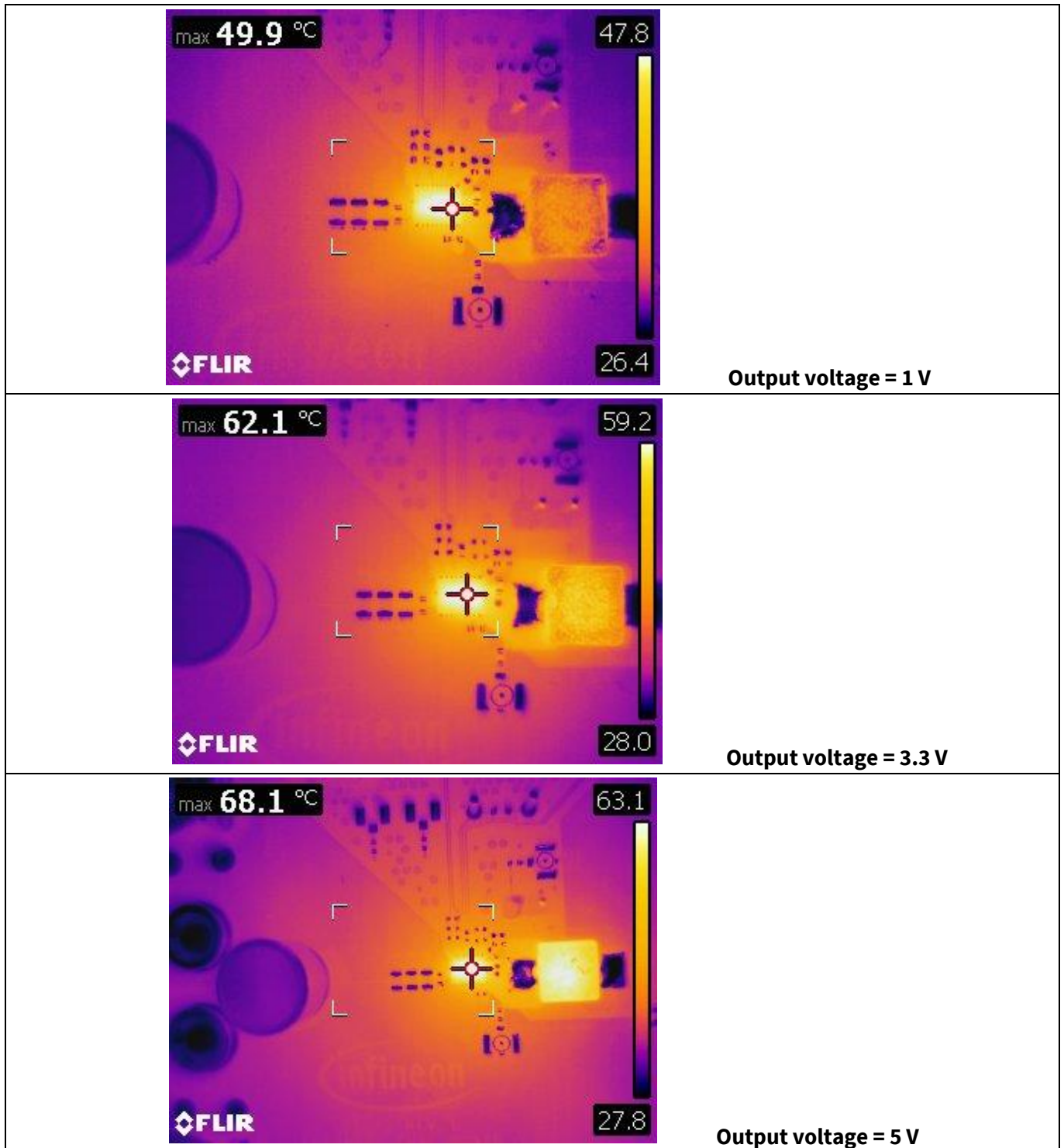

Figure 20 Thermal performance of TDA38813 for 1 V, 3.3 V, and 5 V output voltages, 12 A load, FCCM mode, 800 kHz switching frequency, 12 V V_{IN}

Revision history

Document version	Date of release	Description of changes
V 1.0	2023-07-21	Initial release

Trademarks

All referenced product or service names and trademarks are the property of their respective owners.

Edition 2023-07-21**Published by****Infiniteon Technologies AG****81726 Munich, Germany****© 2023 Infiniteon Technologies AG.****All Rights Reserved.****Do you have a question about this document?****Email:** erratum@infineon.com**Document reference****UM_2307_PL12_2307_173200****Warnings**

Due to technical requirements products may contain dangerous substances. For information on the types in question please contact your nearest Infineon Technologies office.

Except as otherwise explicitly approved by Infineon Technologies in a written document signed by authorized representatives of Infineon Technologies, Infineon Technologies' products may not be used in any applications where a failure of the product or any consequences of the use thereof can reasonably be expected to result in personal injury.