

1986185-1 ✓ ACTIVE

[Dynamic Series](#) | [Dynamic 5000 Series](#)

TE Internal #: 1986185-1

Shield & Strain Relief, Black, Polyester, PBT, 6 Position, Dynamic 5000 Series

[View on TE.com >](#)



Connectors > Connector Accessories > Connector Caps & Covers



Connector Cover Type: **Shield & Strain Relief**

Primary Product Color: **Black**

Primary Product Material: **Polyester, PBT**

Number of Positions: **6**

Operating Temperature (Max): **105 °C [221 °F]**

Features

Product Type Features

Connector Cover Type	Shield & Strain Relief
----------------------	------------------------

Configuration Features

Number of Positions	6
---------------------	---

Body Features

Primary Product Color	Black
Primary Product Material	Polyester, PBT

Mechanical Attachment

Strain Relief	With
---------------	------

Usage Conditions

Operating Temperature (Max)	105 °C[221 °F]
Operating Temperature Range	-55 – 105 °C[-67 – 221 °F]

Industry Standards

UL Flammability Rating	UL 94V-0
------------------------	----------



Product Compliance

[For compliance documentation, visit the product page on TE.com>](#)

EU RoHS Directive 2011/65/EU	Compliant
EU ELV Directive 2000/53/EC	Compliant
China RoHS 2 Directive MIIT Order No 32, 2016	No Restricted Materials Above Threshold
EU REACH Regulation (EC) No. 1907/2006	Current ECHA Candidate List: JAN 2024 (240) Candidate List Declared Against: JAN 2024 (240) Does not contain REACH SVHC
Halogen Content	Not Low Halogen - contains Br or Cl > 900 ppm.
Solder Process Capability	Not applicable for solder process capability

Product Compliance Disclaimer

This information is provided based on reasonable inquiry of our suppliers and represents our current actual knowledge based on the information they provided. This information is subject to change. The part numbers that TE has identified as EU RoHS compliant have a maximum concentration of 0.1% by weight in homogenous materials for lead, hexavalent chromium, mercury, PBB, PBDE, DBP, BBP, DEHP, DIBP, and 0.01% for cadmium, or qualify for an exemption to these limits as defined in the Annexes of Directive 2011/65/EU (RoHS2). Finished electrical and electronic equipment products will be CE marked as required by Directive 2011/65/EU. Components may not be CE marked. Additionally, the part numbers that TE has identified as EU ELV compliant have a maximum concentration of 0.1% by weight in homogenous materials for lead, hexavalent chromium, and mercury, and 0.01% for cadmium, or qualify for an exemption to these limits as defined in the Annexes of Directive 2000/53/EC (ELV). Regarding the REACH Regulation, the information TE provides on SVHC in articles for this part number is based on the latest European Chemicals Agency (ECHA) 'Guidance on requirements for substances in articles' posted at this URL: <https://echa.europa.eu/guidance-documents/guidance-on-reach>

Compatible Parts



Also in the Series | [Dynamic 5000 Series](#)



Connector Caps & Covers(2)

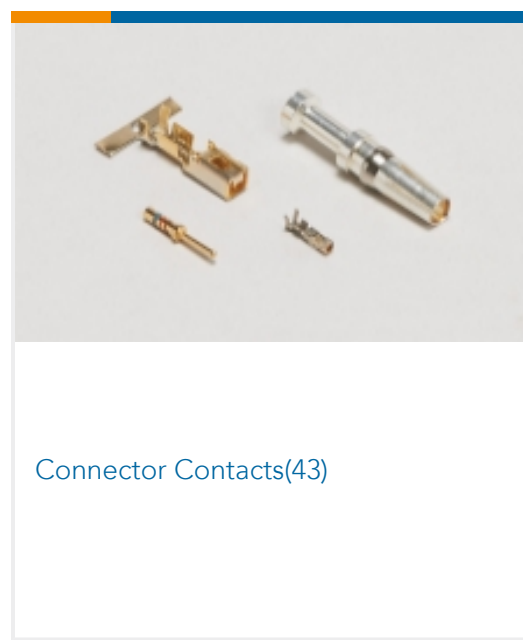

Connector Contacts(43)

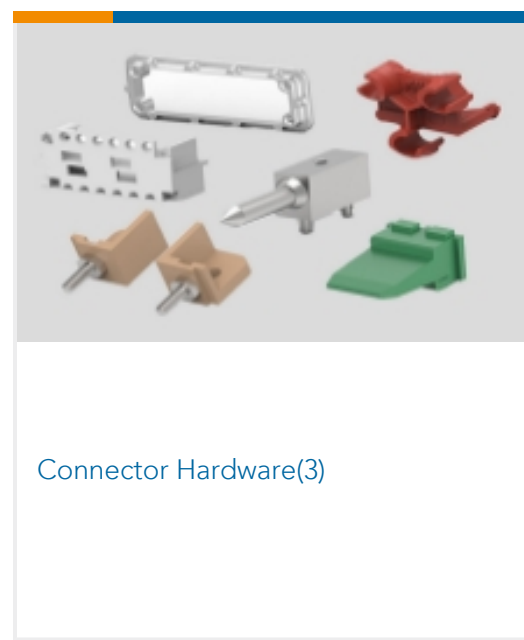

Connector Hardware(3)

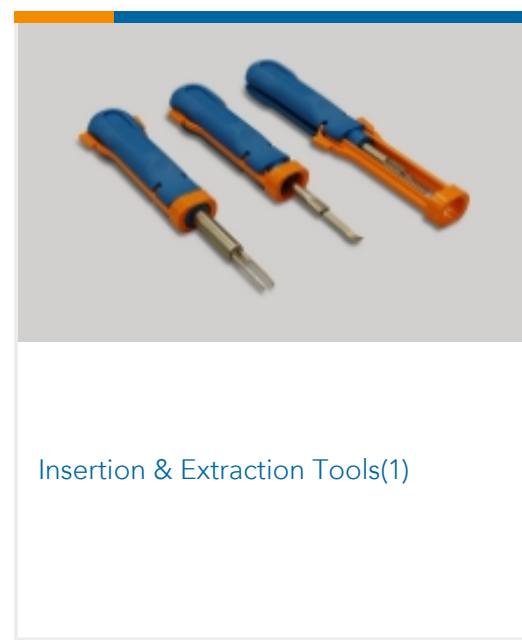

Insertion & Extraction Tools(1)



PCB Headers & Receptacles(59)

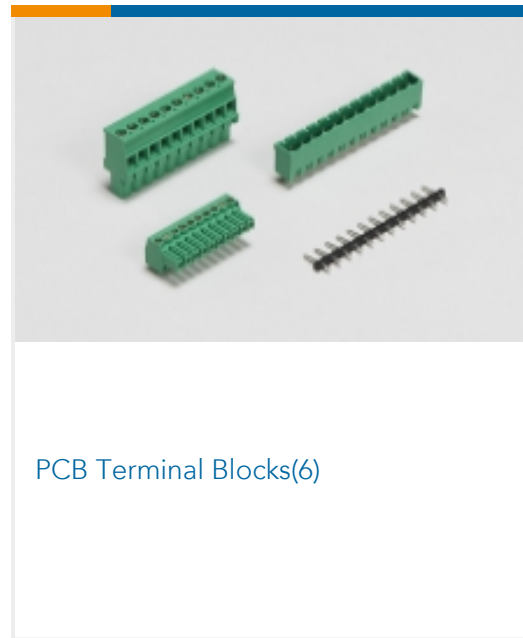

PCB Terminal Blocks(6)

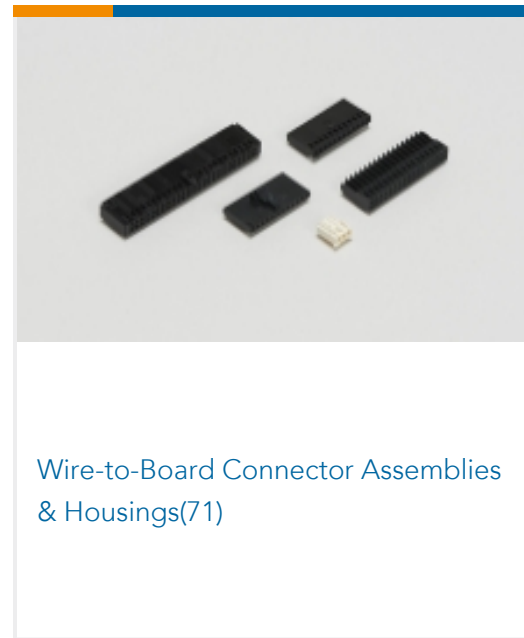

Wire-to-Board Connector Assemblies & Housings(71)

Customers Also Bought



TE Part #DT04-2P
REC, 2P, GRY, N



TE Part #DT06-2S
PLG, 2P, GRY, N



TE Part #W2S
Wedgelocks: DEUTSCH DT

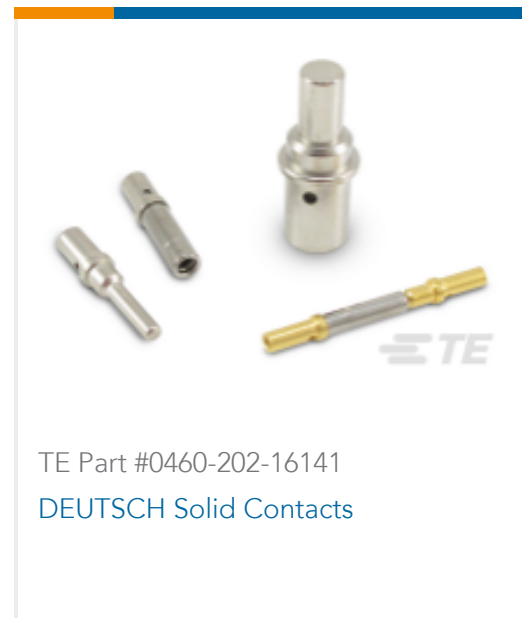

TE Part #0460-202-16141
DEUTSCH Solid Contacts



TE Part #282104-1
AMP SUPERSEAL 1.5MM,
CONNECTOR HOUSING

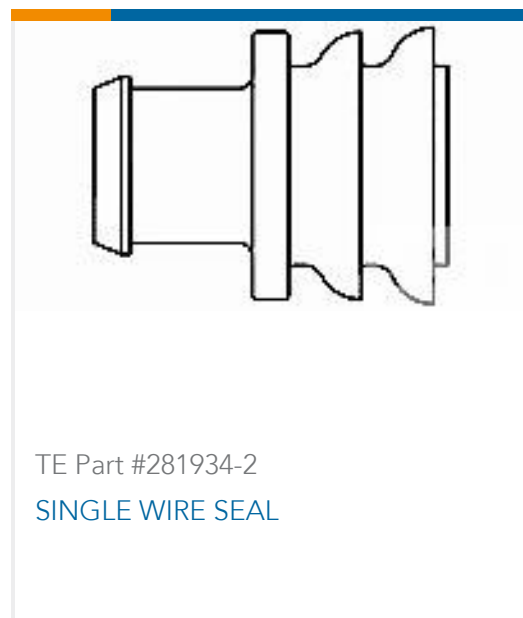

TE Part #281934-2
SINGLE WIRE SEAL



TE Part #114017-ZZ
SEALING PLUG, SIZE 12/16, WHT

Documents

Product Drawings

[Strain Relief,6 Posn,D5200 Dynamic. 2](#)

English

CAD Files

[3D PDF](#)

English

[Customer View Model](#)

[ENG_CVM_1986185-1_A1.2d_dxf.zip](#)



English

Customer View Model

[ENG_CVM_1986185-1_A1.3d_igs.zip](#)

English

Customer View Model

[ENG_CVM_1986185-1_A1.3d_stp.zip](#)

English

By downloading the CAD file I accept and agree to the [Terms and Conditions](#) of use.

Product Specifications

[Product Specification](#)

English