



SL-156

TE Internal #: 770849-8

Housing, Receptacle, Wire-to-Board, 8 Position, .156 in [3.96 mm]
Centerline, Crimp, 1 Row, Natural, Mating Retention, Wire & Cable,
SL-156

[View on TE.com >](#)

Connectors > PCB Connectors > Wire-to-Board Connectors > Wire-to-Board Connector Assemblies & Housings >

Receptacle Housing: Wire-to-Board, with Mating Alignment, SL156



Connector Product Type: **Housing**

Connector & Housing Type: **Receptacle**

Connector System: **Wire-to-Board**

Number of Positions: **8**

Centerline (Pitch): **3.96 mm [.156 in]**

[All Receptacle Housing: Wire-to-Board, with Mating Alignment, SL156 \(107\)](#)

Features

Product Type Features

Connector Product Type	Housing
Connector & Housing Type	Receptacle
Connector System	Wire-to-Board
Sealable	No
Connector & Contact Terminates To	Wire & Cable

Configuration Features

Number of Positions	8
Number of Rows	1

Electrical Characteristics

Operating Voltage	250 VAC
-------------------	---------

Body Features

--	--



Primary Product Color	Natural
-----------------------	---------

Contact Features

Contact Retention Within Housing	Without
Contact Layout	Inline
Contact Type	Socket
Contact Current Rating (Max)	6.5 A

Termination Features

Termination Method to Wire & Cable	Crimp
------------------------------------	-------

Mechanical Attachment

Strain Relief	Without
PCB Mount Alignment	Without
Panel Mount Feature	Without
PCB Mount Retention	Without
Mating Retention Type	Locking Ramp
Mating Retention	With
Connector Mounting Type	Cable Mount (Free-Hanging)

Housing Features

Housing Material	Nylon - GF
Centerline (Pitch)	3.96 mm [.156 in]

Dimensions

	.25 in
Wire Size	.0509 – .823 mm ²

Usage Conditions

Operating Temperature Range	-55 – 105 °C [-67 – 221 °F]
-----------------------------	-----------------------------

Operation/Application

Circuit Application	Power & Signal
---------------------	----------------

Industry Standards

Compatible With Agency/Standards Products	CSA, UL
UL Flammability Rating	UL 94V-0

Packaging Features

Packaging Quantity	500
--------------------	-----



Packaging Method

Bag & Box

Product Compliance

[For compliance documentation, visit the product page on TE.com>](#)

EU RoHS Directive 2011/65/EU	Compliant
EU ELV Directive 2000/53/EC	Compliant
China RoHS 2 Directive MIIT Order No 32, 2016	No Restricted Materials Above Threshold
EU REACH Regulation (EC) No. 1907/2006	Current ECHA Candidate List: JAN 2024 (240) Candidate List Declared Against: JAN 2024 (240) Does not contain REACH SVHC
Halogen Content	Low Halogen - Br, Cl, F, I < 900 ppm per homogenous material. Also BFR/CFR/PVC Free
Solder Process Capability	Not applicable for solder process capability







Product Compliance Disclaimer

This information is provided based on reasonable inquiry of our suppliers and represents our current actual knowledge based on the information they provided. This information is subject to change. The part numbers that TE has identified as EU RoHS compliant have a maximum concentration of 0.1% by weight in homogenous materials for lead, hexavalent chromium, mercury, PBB, PBDE, DBP, BBP, DEHP, DIBP, and 0.01% for cadmium, or qualify for an exemption to these limits as defined in the Annexes of Directive 2011/65/EU (RoHS2). Finished electrical and electronic equipment products will be CE marked as required by Directive 2011/65/EU. Components may not be CE marked. Additionally, the part numbers that TE has identified as EU ELV compliant have a maximum concentration of 0.1% by weight in homogenous materials for lead, hexavalent chromium, and mercury, and 0.01% for cadmium, or qualify for an exemption to these limits as defined in the Annexes of Directive 2000/53/EC (ELV). Regarding the REACH Regulation, the information TE provides on SVHC in articles for this part number is based on the latest European Chemicals Agency (ECHA) 'Guidance on requirements for substances in articles' posted at this URL: <https://echa.europa.eu/guidance-documents/guidance-on-reach>

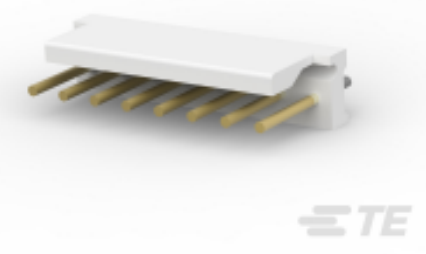
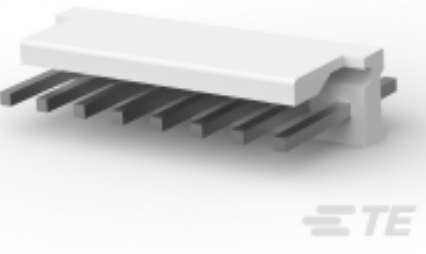
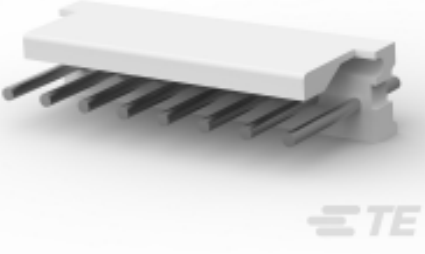

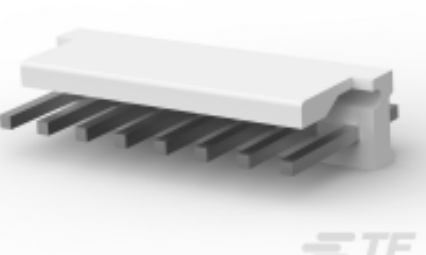

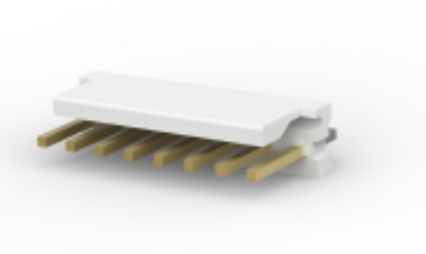
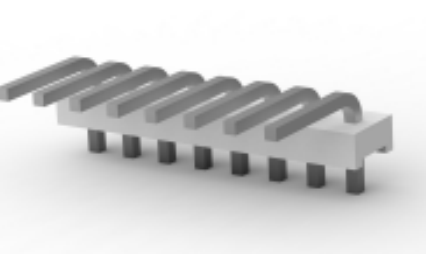
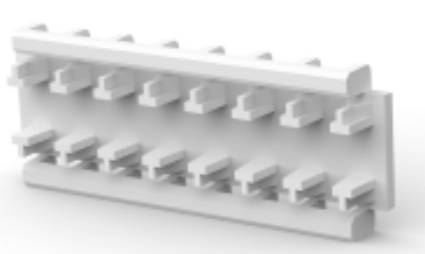
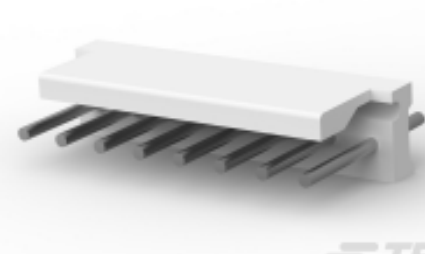
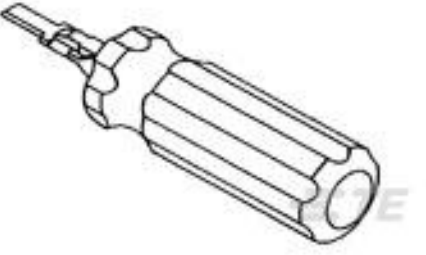
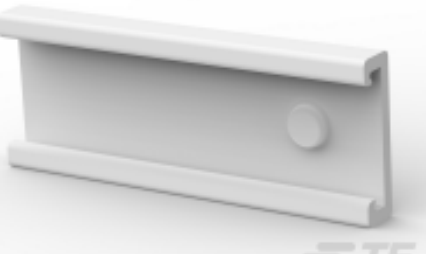
Compatible Parts

 <p>TE Part # 643067-8 08P MTA156 MOLDED COVER</p>	 <p>TE Part # 3-641208-8 08P MTA156 HDR ASSY FL ST LF</p>	 <p>TE Part # 3-641210-8 08P MTA156 HDR FLRA FB 30AU LF</p>	 <p>TE Part # 640389-8 08P MTA156 HDR ASSY SQ R/A F/L</p>
-------------------------------------------------------------------------------------------------------------------------------------------	--------------------------------------------------------------------------------------------------------------------------------------------------	------------------------------------------------------------------------------------------------------------------------------------------------------	----------------------------------------------------------------------------------------------------------------------------------------------------



 <p>TE Part # 640383-8 08P MTA156 HDR ASSY STR SQ SN</p>	 <p>TE Part # 3-641209-8 08P MTA156 HDR ASSY FL ST LF</p>	 <p>TE Part # 644752-8 08P MTA156 HDR ASSY SQ STR F/L</p>	 <p>TE Part # 640388-8 08P MTA156 HDR ASSY RN STR F/L</p>
 <p>TE Part # 3-640445-8 08P MTA156 HDR ASSY FL/STR SN</p>	 <p>TE Part # 641922-3 08P MTA156 HDR ASSY STR W/O#2</p>	 <p>TE Part # 640445-8 08P MTA156 HDR ASSY FL/STR SN</p>	 <p>TE Part # 3-644615-8 08P MTA156 POL HDR ASSY LF</p>
 <p>TE Part # 640551-8 08P MTA156 COVER</p>	 <p>TE Part # 3-641119-8 08P MTA156 HDR ASSY FL/ST LF</p>	 <p>TE Part # 640385-8 08P MTA156 HDR ASSY SQ R/A</p>	 <p>TE Part # 643071-8 08P MTA156 FD-THRU COVER</p>
 <p>TE Part # 644753-8 08P MTA156 HDR ASSY RN STR F/L</p>	 <p>TE Part # 90471-1 EXTRACTION TOOL, SC-156</p>	 <p>TE Part # 640643-8 08P MTA156 COVER F/T</p>	 <p>TE Part # 3-644617-8 08P MTA156 HDR ASSY PO RA FB LF</p>

Also in the Series | **SL-156**

 <p>Connector Contacts(23)</p>	 <p>Connector Hardware(4)</p>	 <p>Insertion & Extraction Tools(1)</p>	 <p>Rectangular Connector Housings(10)</p>
-------------------------------------------------------------------------------------------------------------------	------------------------------------------------------------------------------------------------------------------	----------------------------------------------------------------------------------------------------------------------------------	---------------------------------------------------------------------------------------------------------------------------------

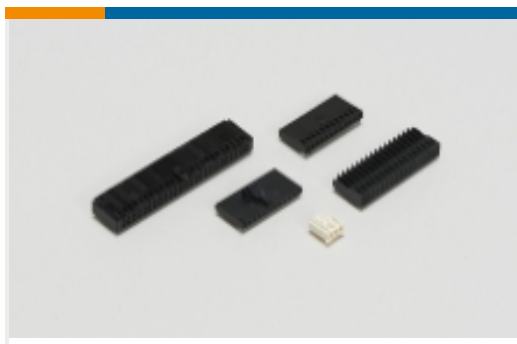

Wire-to-Board Connector Assemblies
& Housings(140)

Customers Also Bought



TE Part #3-640707-1
Connector Contacts: Wire-to-Board
Socket, SL 156



TE Part #1-770849-4
Receptacle Housing: Wire-to-Board,
with Mating Alignment, SL156

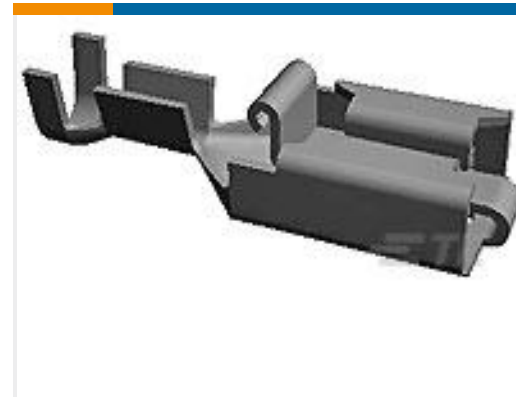

TE Part #154718-1
250 PL MKI REC. 18-14AWG BR



TE Part #647344-7
07P SL156 HSG W/RP TB BLK #3



TE Part #647662-1
EP CONN CONT LUBRICANT SPCL



TE Part #687394-8
HB 9EAPR140T1400 G



TE Part #687871-1
HDM STEAPR120F K

Documents

CAD Files

3D PDF

3D

Customer View Model

[ENG_CVM_CVM_770849-8_Z_c-770849-8-z.2d_dxf.zip](#)

English

Customer View Model

[ENG_CVM_CVM_770849-8_Z_c-770849-8-z.3d_igs.zip](#)

English

Customer View Model

[ENG_CVM_CVM_770849-8_Z_c-770849-8-z.3d_stp.zip](#)

English

By downloading the CAD file I accept and agree to the [Terms and Conditions](#) of use.

Product Specifications

Application Specification

English



[Agency Approvals](#)

[UL Report](#)

English