



Oscar 1A

5G/4G, LoRa, SigFox ISM Omnidirectional Wall Mount Antenna



Key Features

- Supports 5G NR / 4G LTE / 3G UMTS / Quad-band 2G GSM
- Supports LTE Cat M, LTE Cat NB, NR Cat NB bands
- Supports LoRa, Sigfox, IMT 868 MHz, ISM 915 MHz, IEEE 802.15.4
- Improved signal quality with low loss cable
- Housed in a robust ABS casing

General Description

The Oscar 1A is a high-performance Omnidirectional wall/bracket mount antenna, operating on global 4G and 5G frequencies, with great performance on the ISM 868/915 MHz bands. Ruggedly constructed with black ABS plastic over the radiating element and with a lightweight yet durable aluminium mounting bracket.

The high quality monopole design improves communication reliability for applications like remote sensor monitoring, alarm & security systems and other IoT applications demanding an all weather antenna.

Cables are terminated with either an SMA male or FME female connector type. Alternative cable lengths or connector types may be specified for short run volume orders.

Additional Considerations

- Bracket provides secure permanent fixing
- Does not require additional placement on metallic surface

O Wall/Pole	5G New Radio	4G LTE	3G UMTS	2G GSM
LTE Cat M	LTE NB IoT	NR NB IoT	ISM 868	ISM 915
IEEE 802.15.4	LoRa Wireless	SF Sigfox	ZB Zigbee	Z Wave
HNT Helium	W Weightless			



Oscar 1A

5G/4G, LoRa, SigFox ISM Omnidirectional Wall Mount Antenna

Electrical Specifications

Impedance:	50 Ohm
Polarization:	Vertical
Max Input Power:	50 W
Ground plane independent:	Yes

Environmental Specifications

Operating Temperature range:	-20 to +80 °C
Storage Temperature range:	-20 to +80 °C

Mechanical Specifications

Dimensions:	205 mm height x 25 mm diameter
Weight:	250 g
Connector:	SMA Male
Cable:	Low Loss CFD195 4.95 mm diameter
Mounting method:	L-type Mount
Housing materials:	ABS (casing), Aluminium (radiator)

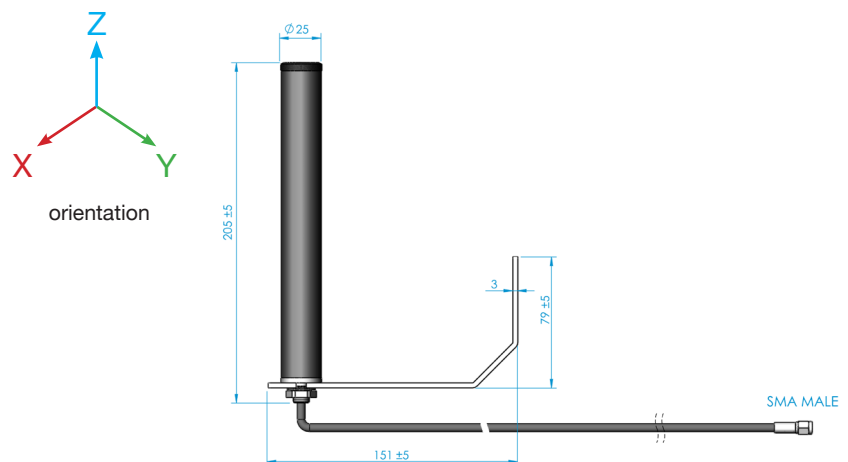



Oscar 1A

5G/4G, LoRa, SigFox ISM Omnidirectional Wall Mount Antenna

Spectrum Coverage

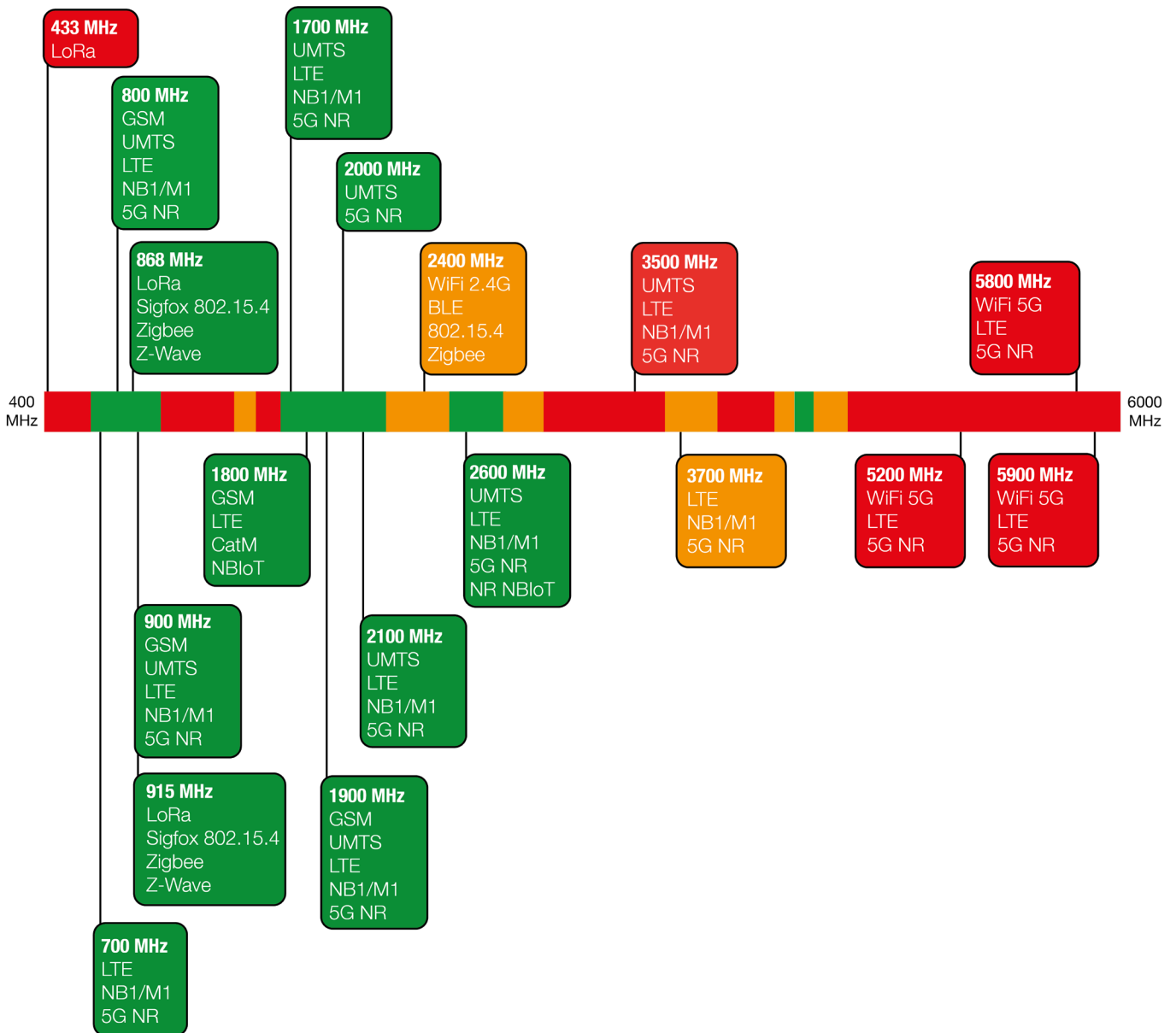

● Suitable band ● Adequate band in good signal conditions ● Likely to be unsuitable



Oscar 1A

5G/4G, LoRa, SigFox ISM Omnidirectional Wall Mount Antenna

Usable Cellular Frequency Support (410 MHz – 1900 MHz)

	410	450	600	700	800	850	900	1500	1600	1700	1800	1900
GSM Bands:						●	●				●	●
UMTS Bands:				●	●	●	●			●	●	●
LTE Bands:				●	●	●	●	●		●	●	●
LTE Cat M Bands:				●	●	●	●			●	●	●
LTE Cat NB Bands:				●	●	●	●			●	●	●
5G NR Bands:				●	●	●	●	●		●	●	●
NR Cat NB Bands:				●	●	●	●			●	●	●

Usable Cellular Frequency Support (2000 MHz – 5900 MHz)

	2000	2100	2300	2400	2500	2600	3300	3500	3700	4700	5200	5900
GSM Bands:												
UMTS Bands:		●				●						
LTE Bands:	●	●			●	●						
LTE Cat M Bands:		●			●	●						
LTE Cat NB Bands:		●			●	●						
5G NR Bands:	●	●			●	●						
NR Cat NB Bands:		●			●	●						

Usable ISM Frequency Support (433 MHz - 5800 MHz)

	433	868	915	2450	5800
Bluetooth					
IEEE 802.15.4		●	●		
LoRa		●	●		
Sigfox		●	●		
WiFi 2.4G					
WiFi 5G					
Zigbee		●	●		
Z-Wave		●	●		



Oscar 1A

5G/4G, LoRa, SigFox ISM Omnidirectional Wall Mount Antenna

Peak Gain vs. Frequency

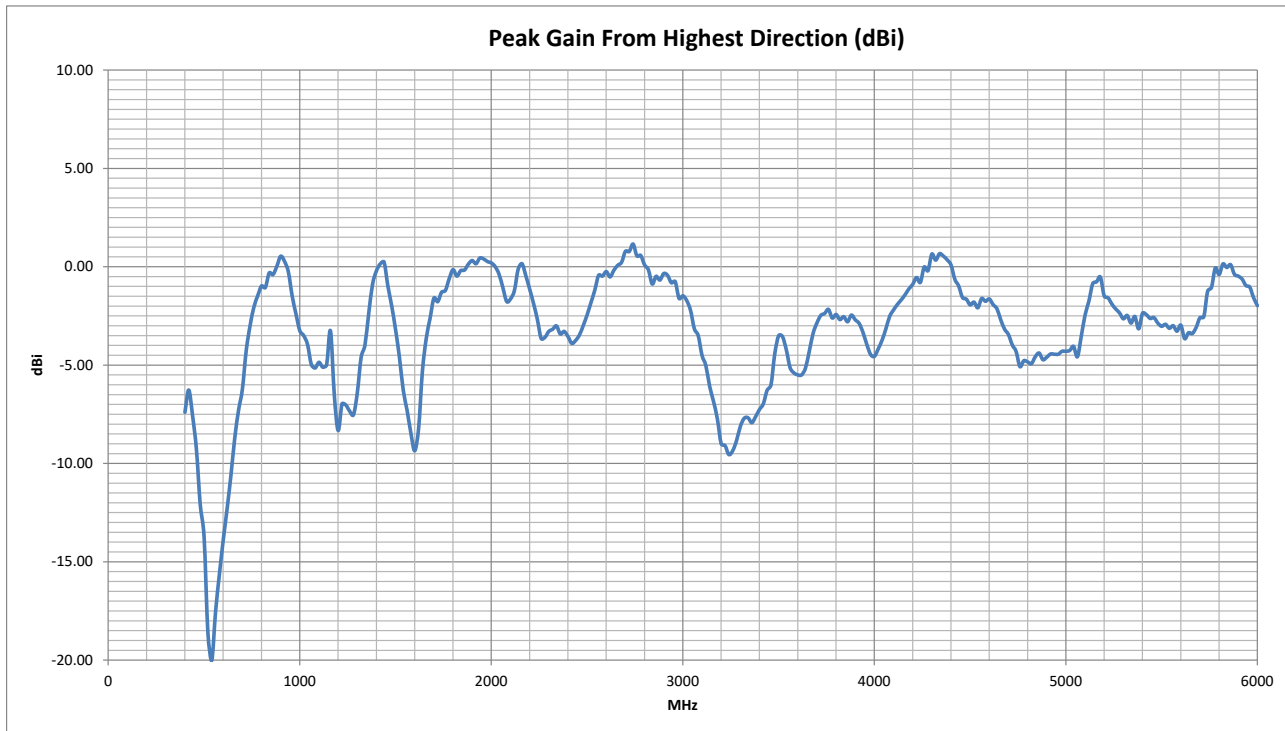

Return Loss

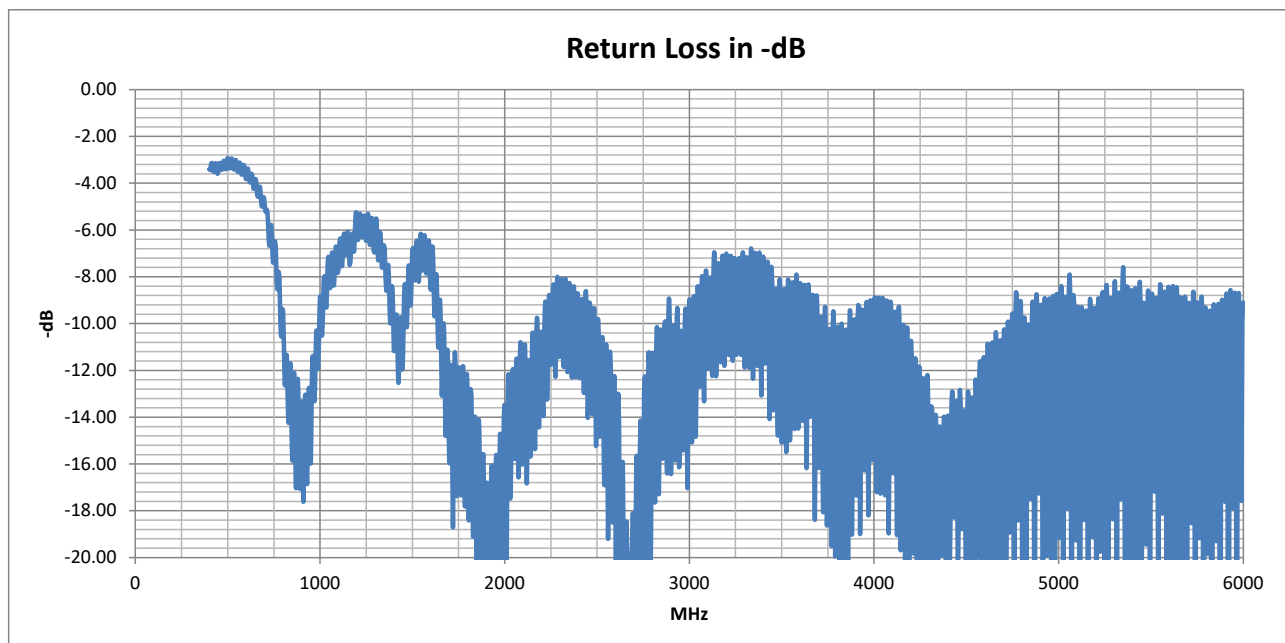



Oscar 1A

5G/4G, LoRa, SigFox ISM Omnidirectional Wall Mount Antenna

VSWR

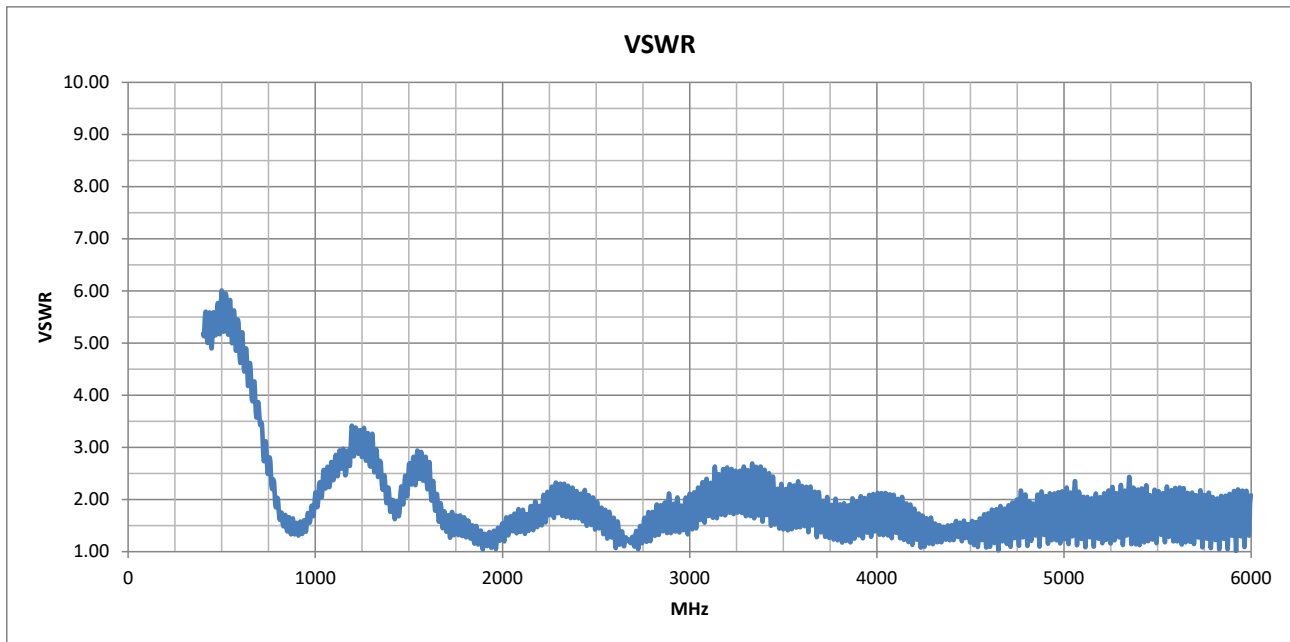

Radiation Efficiency

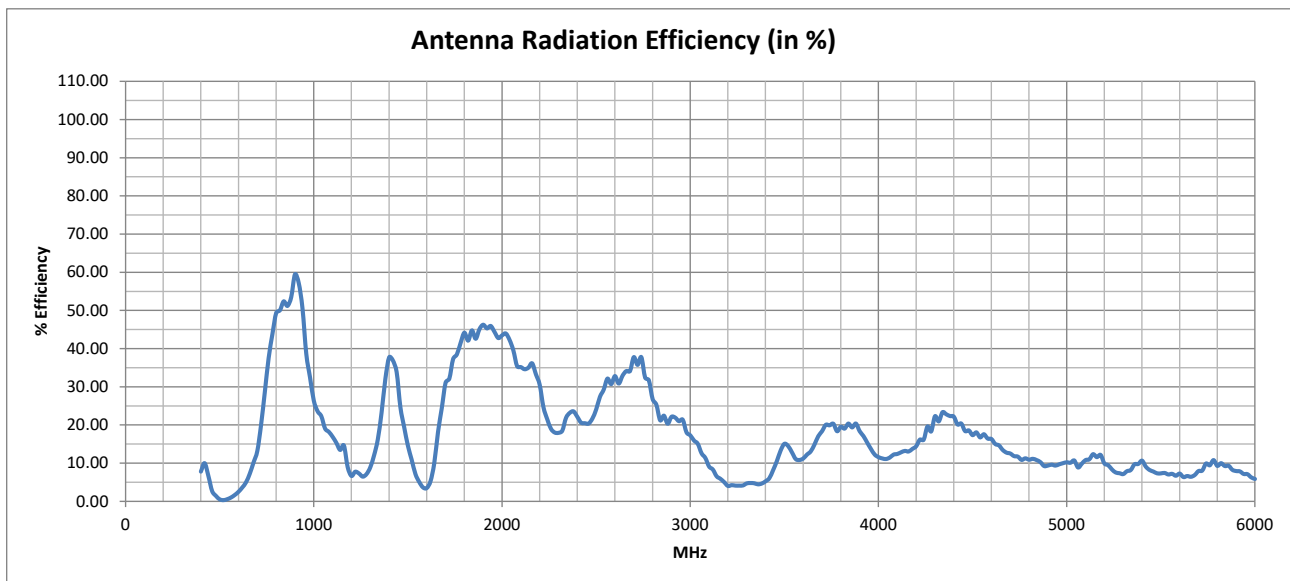



Oscar 1A

5G/4G, LoRa, SigFox ISM Omnidirectional Wall Mount Antenna

Cellular Standards Band Support

GSM (2G) Band	UMTS (3G) Band	E-UTRA (4G) Band	Cat M E-UTRA Band	Cat NB E-UTRA Band	NR (5G) Band	Cat NB NR (5G) Band	Uplink	Downlink	Average Upload Efficiency (%)	Average Download Efficiency (%)	Maximum Upload VSWR	Maximum Download VSWR	Use Indicator
	1	1	1	1	n1	n1	1920 - 1980 MHz	2110 - 2170 MHz	44.77	35.15	1.45	1.86	●
PCS-1900	2	2	2	2	n2	n2	1850 - 1910 MHz	1930 - 1990 MHz	44.68	44.35	1.49	1.45	●
DCS-1800	3	3	3	3	n3	n3	1710 - 1785 MHz	1805 - 1880 MHz	37.04	43.48	1.76	1.59	●
	4	4	4	4			1710 - 1755 MHz	2110 - 2155 MHz	35.06	34.99	1.76	1.86	●
GSM-850	5	5	5	5	n5	n5	824 - 849 MHz	869 - 894 MHz	51.66	54.35	1.70	1.63	●
	6						830 - 840 MHz	875 - 885 MHz	51.77	53.69	1.70	1.63	●
	7	7	7	7	n7	n7	2500 - 2570 MHz	2620 - 2690 MHz	28.73	33.43	1.96	1.44	●
E-GSM-900	8	8	8	8	n8	n8	880 - 915 MHz	925 - 960 MHz	57.35	48.16	1.63	1.74	●
	9	9					1749.9 - 1784.9 MHz	1844.9 - 1879.9 MHz	39.71	43.64	1.69	1.49	●
	10	10					1710 - 1770 MHz	2110 - 2170 MHz	36.03	35.15	1.76	1.86	●
	11	11	11	11			1427.9 - 1447.9 MHz	1475.9 - 1495.9 MHz	33.71	18.01	1.97	2.45	●
	12	12	12	12	n12	n12	699 - 716 MHz	729 - 746 MHz	15.80	27.64	3.69	3.11	●
	13	13	13	13	n13	n13	777 - 787 MHz	746 - 756 MHz	44.29	33.54	2.36	2.81	●
	14	14	14	14	n14		788 - 798 MHz	758 - 768 MHz	47.37	38.41	2.03	2.75	●
		17		17			704 - 716 MHz	734 - 746 MHz	16.65	28.72	3.48	3.11	●
		18	18	18	n18	n18	815 - 830 MHz	860 - 875 MHz	50.37	52.03	1.74	1.66	●
	19	19	19	19			830 - 845 MHz	875 - 890 MHz	51.92	54.36	1.70	1.63	●
	20	20	20	20	n20	n20	832 - 862 MHz	791 - 821 MHz	51.76	49.19	1.70	2.03	●
	21	21	21	21			1447.9 - 1462.9 MHz	1495.9 - 1510.9 MHz	26.84	13.97	2.25	2.69	●
	22	22					3410 - 3490 MHz	3510 - 3590 MHz	9.55	12.35	2.49	2.35	●
		24	24	24	n24		1626.5 - 1660.5 MHz	1525 - 1559 MHz	11.91	7.22	2.35	2.94	●
	25	25	25	25	n25	n25	1850 - 1915 MHz	1930 - 1995 MHz	44.75	44.26	1.49	1.48	●
	26	26	26	26	n26		814 - 849 MHz	859 - 894 MHz	51.20	53.58	1.74	1.66	●
		27	27				807 - 824 MHz	852 - 869 MHz	49.89	51.56	1.74	1.66	●
		28	28	28	n28	n28	703 - 748 MHz	758 - 803 MHz	22.75	43.67	3.52	2.75	●

● Suitable band

● Adequate band in good signal conditions

● Likely to be unsuitable



Oscar 1A

5G/4G, LoRa, SigFox ISM Omnidirectional Wall Mount Antenna

Cellular Standards Band Support

GSM (2G) Band	UMTS (3G) Band	E-UTRA (4G) Band	Cat M E-UTRA Band	Cat NB E-UTRA Band	NR (5G) Band	Cat NB NR (5G) Band	Uplink	Downlink	Average Upload Efficiency (%)	Average Download Efficiency (%)	Maximum Upload VSWR	Maximum Download VSWR	Use Indicator
		28A					703 - 733 MHz	758 - 788 MHz	19.65	41.52	3.52	2.75	●
		29			n29		N/A	717 - 728 MHz	N/A	21.20	N/A	3.27	●
		30			n30		2305 - 2315 MHz	2350 - 2360 MHz	18.22	22.85	2.29	2.25	●
		31	31	31			452.5 - 457.5 MHz	462.5 - 467.5 MHz	3.67	2.37	5.58	5.36	●
	32	32					N/A	1452 - 1496 MHz	N/A	21.21	N/A	2.45	●
		33					1900 - 1920 MHz	1900 - 1920 MHz	45.76	45.76	1.34	1.34	●
		34			n34		2010 - 2025 MHz	2010 - 2025 MHz	43.80	43.80	1.65	1.65	●
		35					1850 - 1910 MHz	1850 - 1910 MHz	44.68	44.68	1.49	1.49	●
		36					1930 - 1990 MHz	1930 - 1990 MHz	44.35	44.35	1.45	1.45	●
		37					1910 - 1930 MHz	1910 - 1930 MHz	45.49	45.49	1.37	1.37	●
		38			n38		2570 - 2620 MHz	2570 - 2620 MHz	31.64	31.64	1.76	1.76	●
		39	39		n39		1880 - 1920 MHz	1880 - 1920 MHz	45.71	45.71	1.40	1.40	●
		40	40		n40		2300 - 2400 MHz	2300 - 2400 MHz	21.43	21.43	2.30	2.30	●
		41	41	41	n41	n41	2496 - 2690 MHz	2496 - 2690 MHz	31.07	31.07	1.96	1.96	●
		42	42	42			3400 - 3600 MHz	3400 - 3600 MHz	11.06	11.06	2.56	2.56	●
		43	43	43			3600 - 3800 MHz	3600 - 3800 MHz	16.97	16.97	2.25	2.25	●
		44					703 - 803 MHz	703 - 803 MHz	33.33	33.33	3.52	3.52	●
		45					1447 - 1467 MHz	1447 - 1467 MHz	26.29	26.29	2.25	2.25	●
		46			n46		5150 - 5925 MHz	5150 - 5925 MHz	8.46	8.46	2.43	2.43	●
		47			n47		5855 - 5925 MHz	5855 - 5925 MHz	8.31	8.31	2.16	2.16	●
		48			n48		3550 - 3700 MHz	3550 - 3700 MHz	13.31	13.31	2.35	2.35	●
		49					3550 - 3700 MHz	3550 - 3700 MHz	13.31	13.31	2.35	2.35	●
		50			n50		1432 - 1517 MHz	1432 - 1517 MHz	21.93	21.93	2.69	2.69	●
		51			n51		1427 - 1432 MHz	1427 - 1432 MHz	35.47	35.47	1.86	1.86	●
		52					3300 - 3400 MHz	3300 - 3400 MHz	4.74	4.74	2.69	2.69	●

● Suitable band

● Adequate band in good signal conditions

● Likely to be unsuitable



Oscar 1A

5G/4G, LoRa, SigFox ISM Omnidirectional Wall Mount Antenna

Cellular Standards Band Support

GSM (2G) Band	UMTS (3G) Band	E-UTRA (4G) Band	Cat M E-UTRA Band	Cat NB E-UTRA Band	NR (5G) Band	Cat NB NR (5G) Band	Uplink	Downlink	Average Upload Efficiency (%)	Average Download Efficiency (%)	Maximum Upload VSWR	Maximum Download VSWR	Use Indicator
		53			n53		2483.5 - 2495 MHz	2483.5 - 2495 MHz	22.77	22.77	2.03	2.03	●
		65		65	n65	n65	1920 - 2010 MHz	2110 - 2200 MHz	44.27	34.30	1.54	1.96	●
		66	66	66	n66	n66	1710 - 1780 MHz	2110 - 2200 MHz	36.70	34.30	1.76	1.96	●
		67			n67		N/A	738 - 758 MHz	N/A	32.22	N/A	2.96	●
		68					698 - 728 MHz	753 - 783 MHz	17.79	39.89	3.74	2.81	●
		69					N/A	2570 - 2620 MHz	N/A	31.64	N/A	1.76	●
		70		70	n70	n70	1695 - 1710 MHz	1995 - 2020 MHz	30.95	43.63	1.70	1.65	●
		71	71	71	n71		663 - 698 MHz	617 - 652 MHz	10.30	4.72	4.26	4.90	●
		72	72	72			451 - 456 MHz	461 - 466 MHz	3.97	2.46	5.58	5.48	●
		73	73	73			450 - 455 MHz	460 - 465 MHz	4.17	2.52	5.58	5.56	●
		74	74	74	n74		1427 - 1470 MHz	1475 - 1518 MHz	29.59	15.65	2.25	2.69	●
		75			n75		N/A	1432 - 1517 MHz	N/A	21.93	N/A	2.69	●
		76			n76		N/A	1427 - 1432 MHz	N/A	35.47	N/A	1.86	●
					n77		3300 - 4200 MHz	3300 - 4200 MHz	13.33	13.33	2.69	2.69	●
					n78		3300 - 3800 MHz	3300 - 3800 MHz	12.16	12.16	2.69	2.69	●
					n79		4400 - 5000 MHz	4400 - 5000 MHz	13.70	13.70	2.17	2.17	●
					n80		1710 - 1785 MHz	N/A	37.04	N/A	1.76	N/A	●
					n81		880 - 915 MHz	N/A	57.35	N/A	1.63	N/A	●
					n82		832 - 862 MHz	N/A	51.76	N/A	1.70	N/A	●
					n83		703 - 748 MHz	N/A	22.75	N/A	3.52	N/A	●
					n84		1920 - 1980 MHz	N/A	44.77	N/A	1.45	N/A	●
		85	85	85	n85		698 - 716 MHz	728 - 746 MHz	15.64	27.42	3.74	3.11	●
					n86		1710 - 1780 MHz	N/A	36.70	N/A	1.76	N/A	●
		87	87	87			410 - 415 MHz	420 - 425 MHz	9.17	9.58	5.59	5.15	●
		88	88	88			412 - 417 MHz	422 - 427 MHz	9.39	9.25	5.59	5.13	●

● Suitable band

● Adequate band in good signal conditions

● Likely to be unsuitable



Oscar 1A

5G/4G, LoRa, SigFox ISM Omnidirectional Wall Mount Antenna

Cellular Standards Band Support

GSM (2G) Band	UMTS (3G) Band	E-UTRA (4G) Band	Cat M E-UTRA Band	Cat NB E-UTRA Band	NR (5G) Band	Cat NB NR (5G) Band	Uplink	Downlink	Average Upload Efficiency (%)	Average Download Efficiency (%)	Maximum Upload VSWR	Maximum Download VSWR	Use Indicator
					n89		824 - 849 MHz	N/A	51.66	N/A	1.70	N/A	●
					n90	n90	2496 - 2690 MHz	2496 - 2690 MHz	31.07	31.07	1.96	1.96	●
					n91		832 - 862 MHz	1427 - 1432 MHz	51.76	35.47	1.70	1.86	●
					n92		832 - 862 MHz	1432 - 1517 MHz	51.76	21.93	1.70	2.69	●
					n93		880 - 915 MHz	1427 - 1432 MHz	57.35	35.47	1.63	1.86	●
					n94		880 - 915 MHz	1432 - 1517 MHz	57.35	21.93	1.63	2.69	●
					n95		2010 - 2025 MHz	N/A	43.80	N/A	1.65	N/A	●
					n97		2300 - 2400 MHz	N/A	21.43	N/A	2.30	N/A	●
					n98		1880 - 1920 MHz	N/A	45.71	N/A	1.40	N/A	●
					n99		1626.5 - 1660.5 MHz	N/A	11.91	N/A	2.35	N/A	●
					n101		1900 - 1910 MHz	1900 - 1910 MHz	46.00	46.00	1.34	1.34	●
				103			787 - 788 MHz	757 - 758 MHz	45.84	36.40	1.91	2.77	●

● Suitable band

● Adequate band in good signal conditions

● Likely to be unsuitable

NOTE: For each frequency band, Siretta provides a traffic light indication to show the suitability of the antenna for use at that frequency band. Determination of exactly what makes an antenna good or bad at any frequency is subjective.

The view presented is that of Siretta's engineering team having taken into account the efficiency and VSWR measurements. The end user is advised to use their own criteria and/or testing to confirm suitability.



ISM Standards Frequency Support

Application	Frequency Range	Efficiency (%)	Maximum VSWR	Peak Gain from highest direction (dBi)	Use Indicator
ISM 433 MHz	433.05 - 434.79 MHz	7.67	5.57	-7.1215	●
IMT 868 MHz	863 - 870 MHz	51.91	1.55	-0.19	●
ISM 915 MHz	902 - 928 MHz	57.45	1.57	0.504	●
ISM 2.4 GHz	2400 - 2500 MHz	21.24	2.18	-2.45	●
Wi-Fi 2.4G	2401 - 2483 MHz	20.86	2.18	-2.909	●
Wi-Fi 2.4G (USA)	2401 - 2473 MHz	20.76	2.18	-3.158	●
Wi-Fi 2.4G (Japan)	2401 - 2495 MHz	21.10	2.18	-2.585	●
Wi-Fi 5G (all channels)	5150 - 5990 MHz	8.35	2.43	0.14	●
Wi-Fi 5G (Ch 32-48)	5150 - 5250 MHz	10.31	2.17	-0.53	●
Wi-Fi 5G (Ch 32-64)	5150 - 5330 MHz	9.08	2.28	-0.53	●
Wi-Fi 5G (Ch 32-161)	5150 - 5815 MHz	8.42	2.43	0.005	●
Wi-Fi 5G (Ch 32-173)	5150 - 5875 MHz	8.50	2.43	0.14	●
ISM 5.8 GHz	5725 - 5875 MHz	9.60	2.17	0.14	●

● Suitable band

● Adequate band in good signal conditions

● Likely to be unsuitable

NOTE: For each frequency band, Siretta provides a traffic light indication to show the suitability of the antenna for use at that frequency band. Determination of exactly what makes an antenna good or bad at any frequency is subjective.

The view presented is that of Siretta's engineering team having taken into account the efficiency and VSWR measurements. The end user is advised to use their own criteria and/or testing to confirm suitability.



Oscar 1A

5G/4G, LoRa, SigFox ISM Omnidirectional Wall Mount Antenna

2D Radiation Plots

700 MHz XY

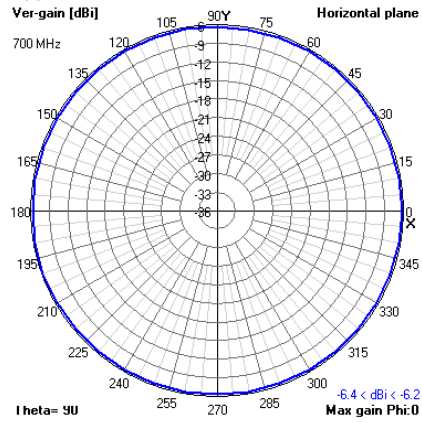

XZ

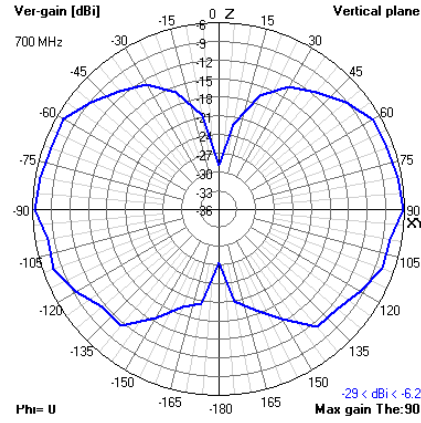

YZ

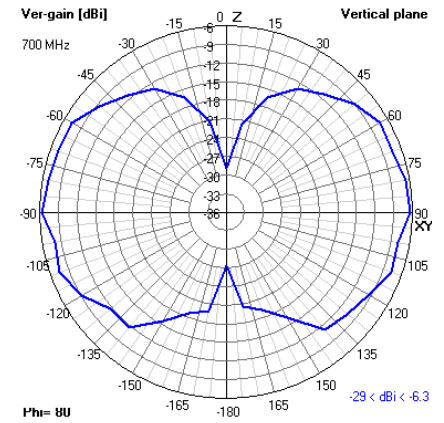

800 MHz XY

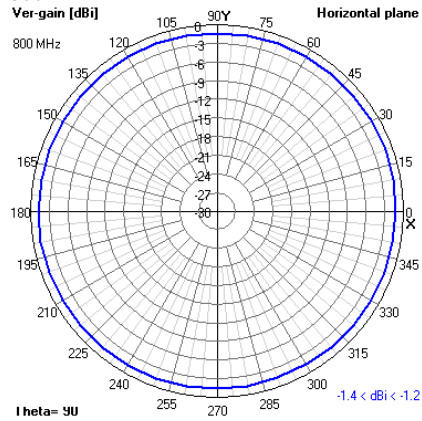

XZ

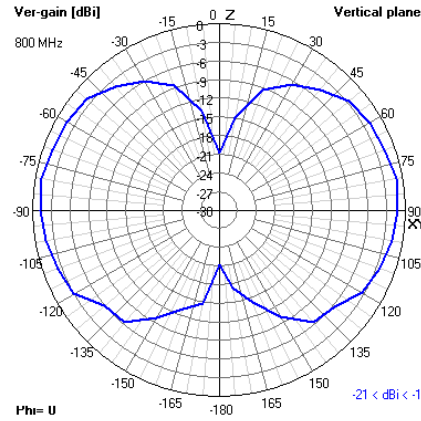

YZ

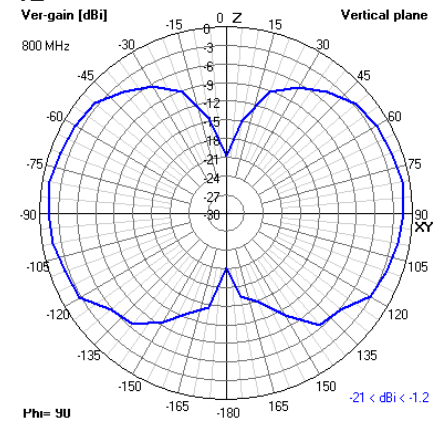

900 MHz XY

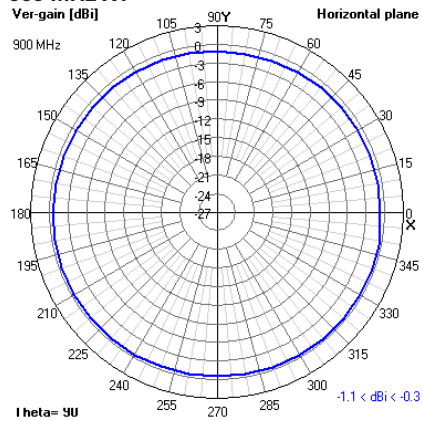

XZ

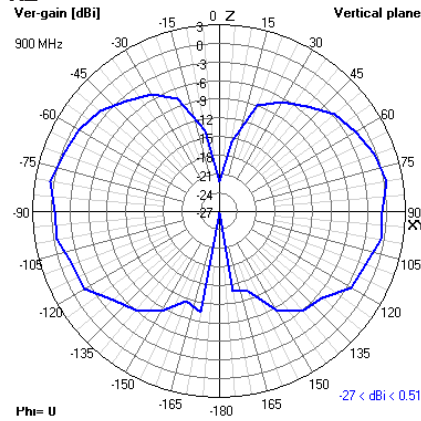

YZ

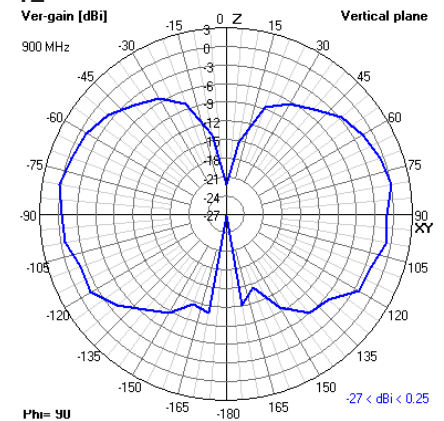



Oscar 1A

5G/4G, LoRa, SigFox ISM Omnidirectional Wall Mount Antenna

2D Radiation Plots

1500 MHz XY

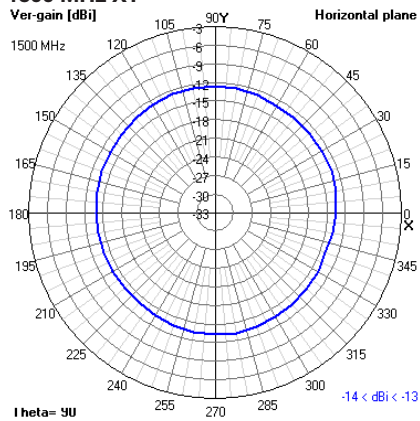

XZ

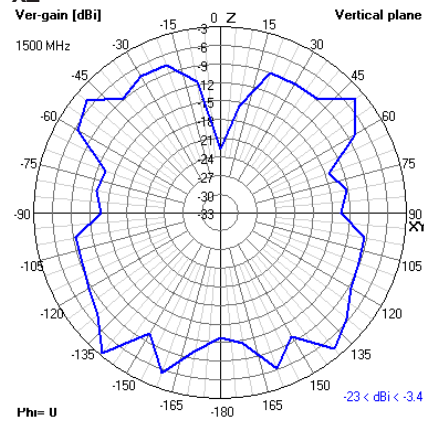

YZ

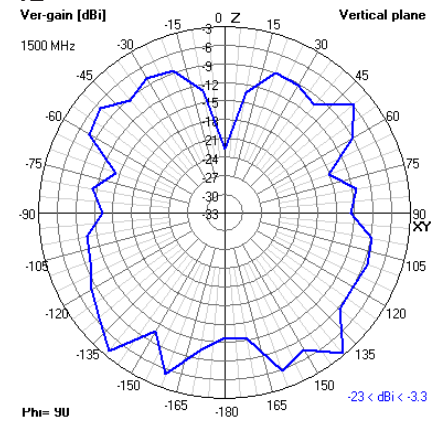

1700 MHz XY

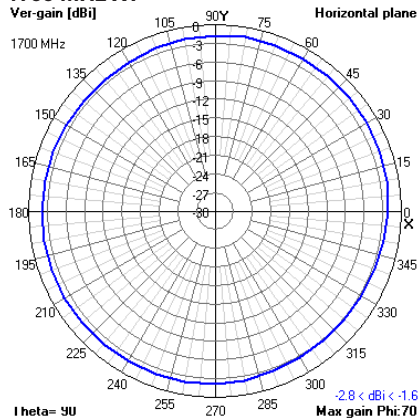

XZ

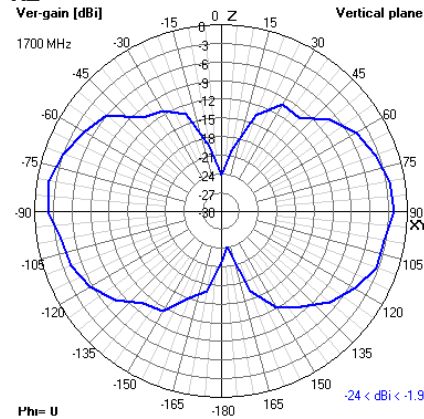

YZ

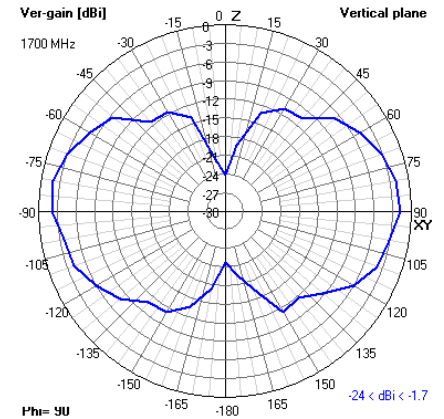

1800 MHz XY

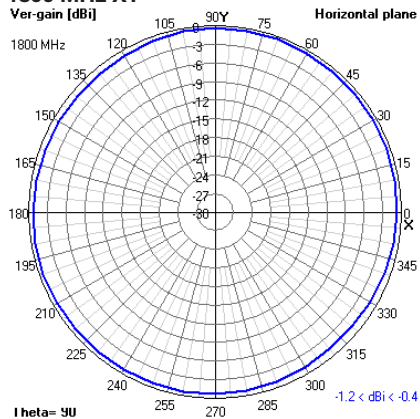

XZ

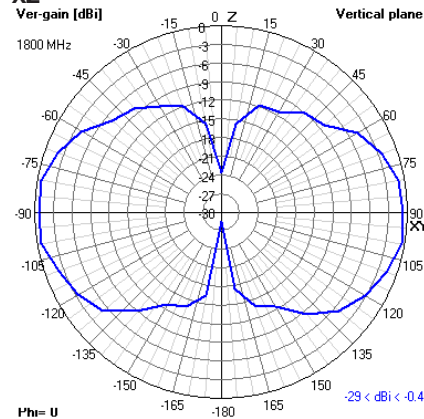

YZ

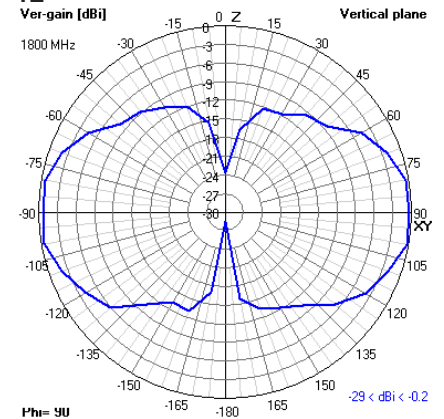



Oscar 1A

5G/4G, LoRa, SigFox ISM Omnidirectional Wall Mount Antenna

2D Radiation Plots

1900 MHz XY

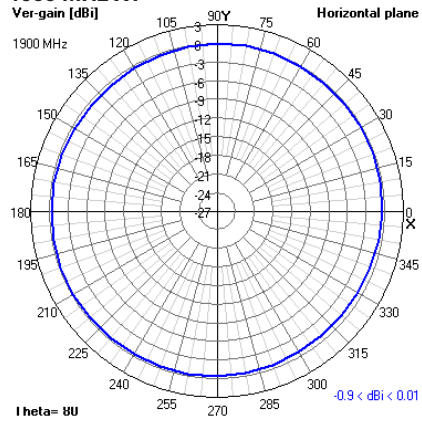

XZ

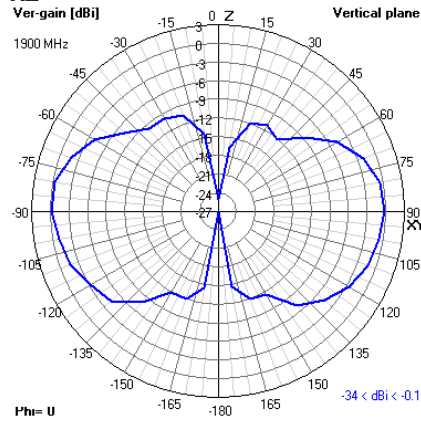

YZ

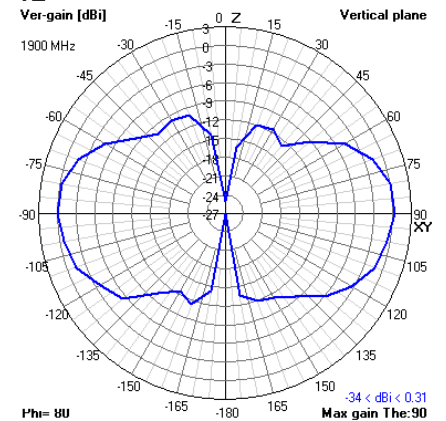

2000 MHz XY

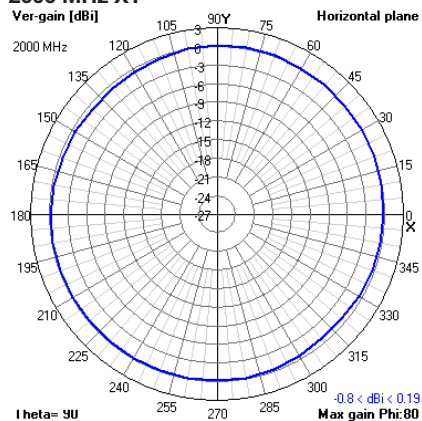

XZ

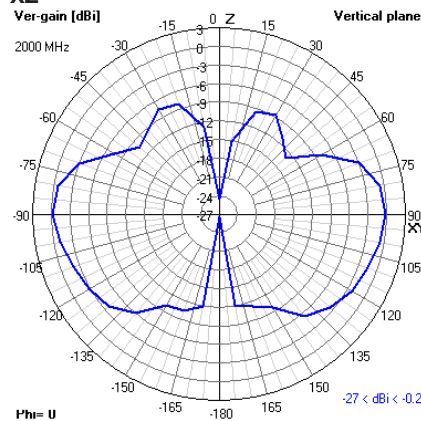

YZ

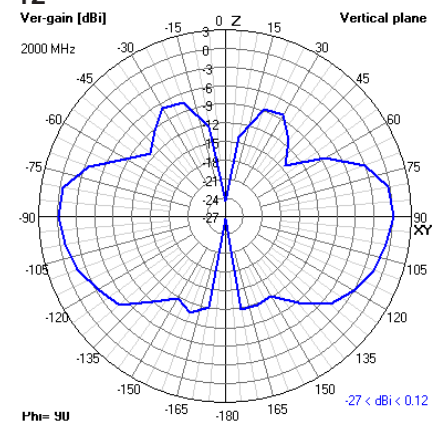

2100 MHz XY

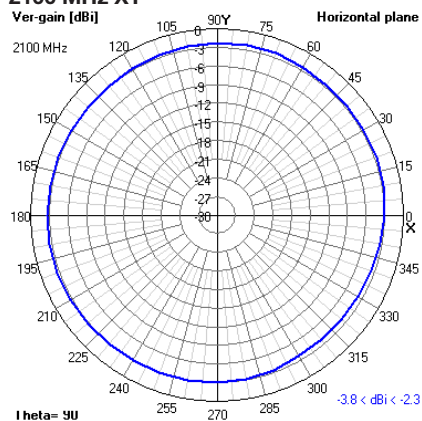

XZ

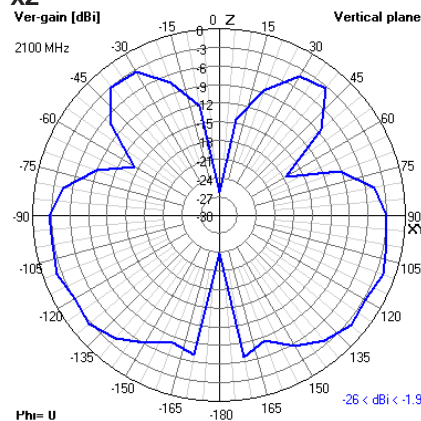

YZ

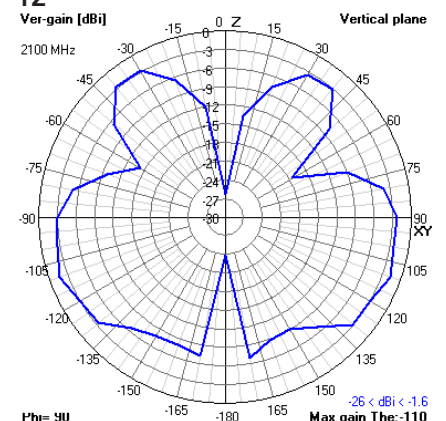



Oscar 1A

5G/4G, LoRa, SigFox ISM Omnidirectional Wall Mount Antenna

2D Radiation Plots

2500 MHz XY

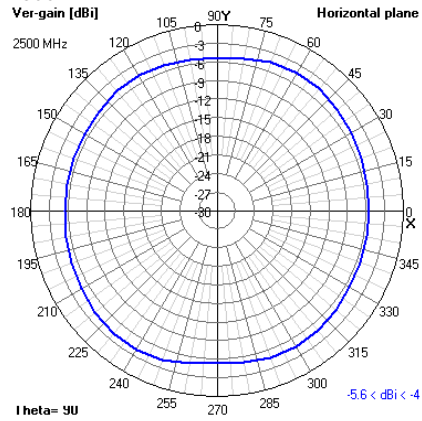

XZ

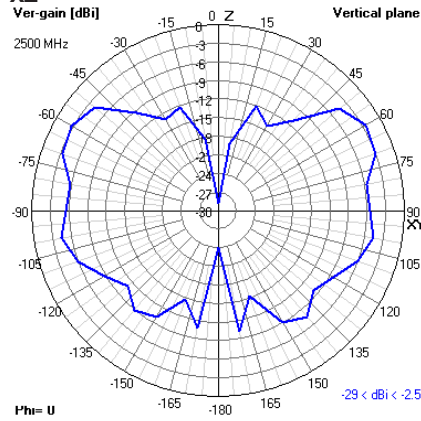

YZ

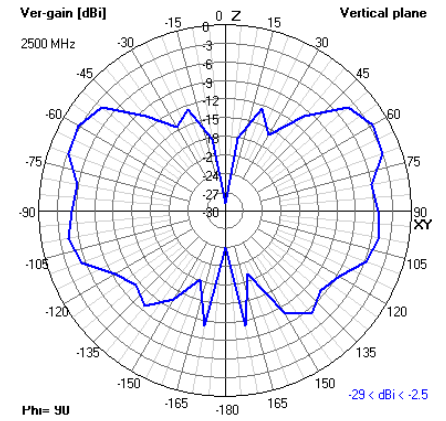

2600 MHz XY

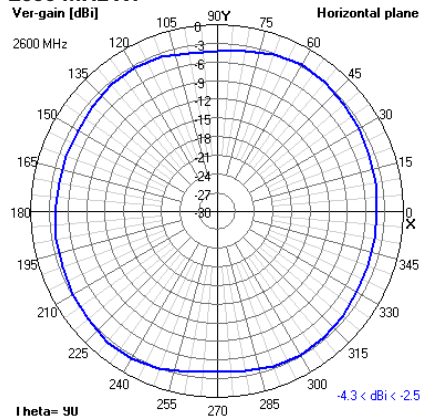

XZ

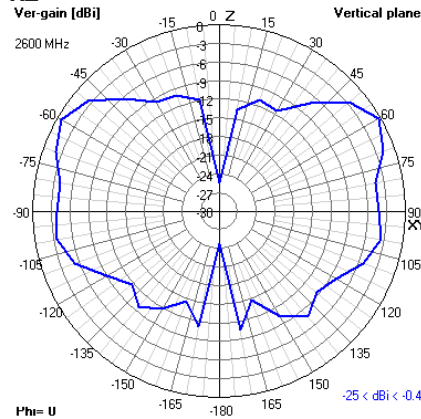

YZ

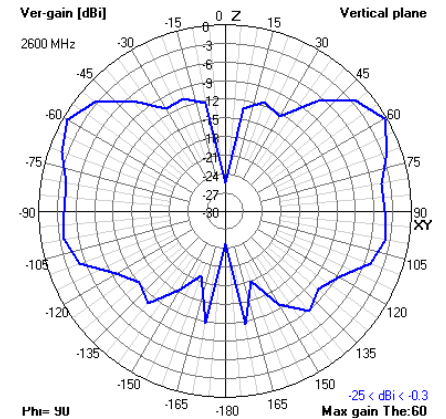



Oscar 1A

5G/4G, LoRa, SigFox ISM Omnidirectional Wall Mount Antenna

3D Radiation Plots

700 MHz

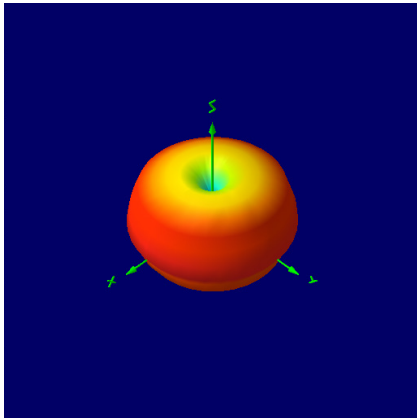

800 MHz

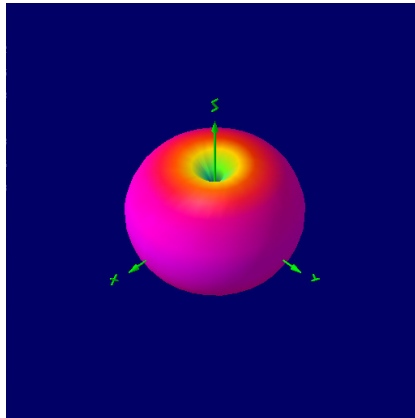

900 MHz

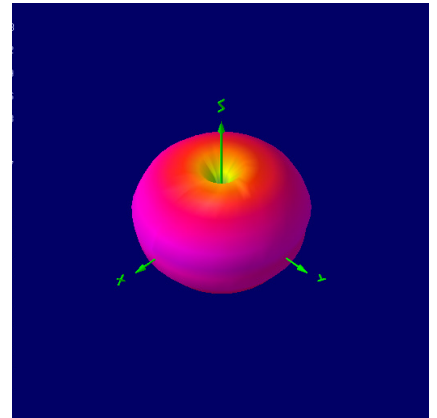

1500 MHz

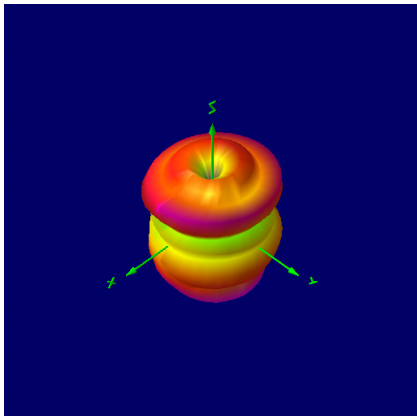

1700 MHz

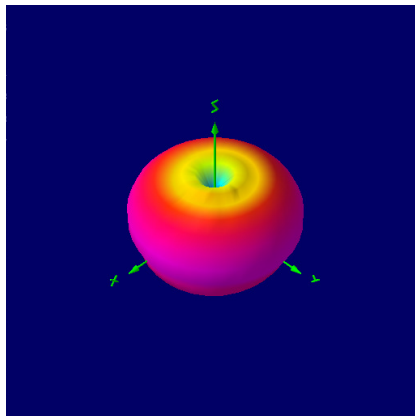

1800 MHz

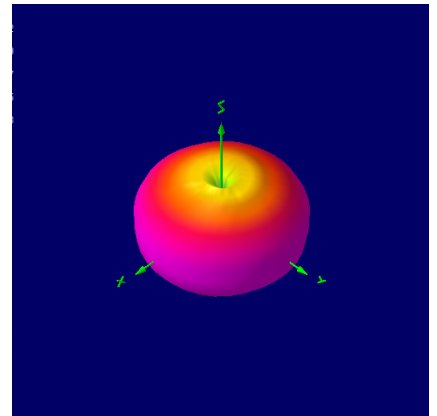

1900 MHz

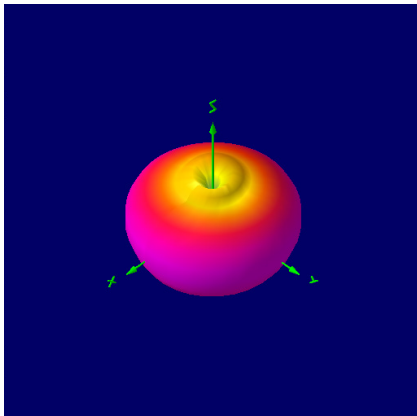

2000 MHz

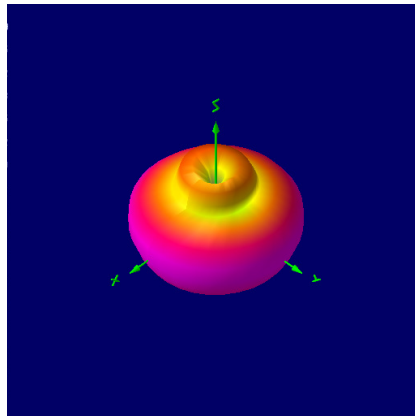

2100 MHz

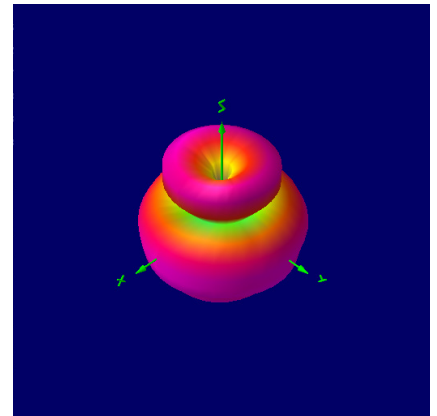



Oscar 1A

5G/4G, LoRa, SigFox ISM Omnidirectional Wall Mount Antenna

3D Radiation Plots

2500 MHz

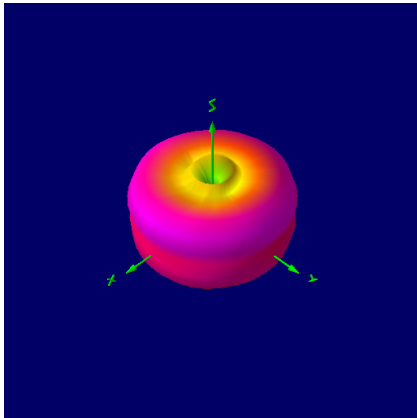

2600 MHz

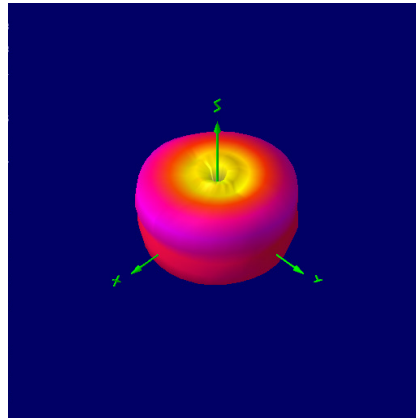

NOTE: All 3D radiation plots are shown with Theta = 45 and Phi = 45.

Ordering Details:

Part Number	Description
OSCAR1A/0.2M/FMEF/S/S/31	5G/4G, LoRa, SigFox ISM Omnidirectional Wall Mount Antenna FME Female Connector 0.2M Cable
OSCAR1A/5M/FMEF/S/S/31	5G/4G, LoRa, SigFox ISM Omnidirectional Wall Mount Antenna FME Female Connector 5M Cable
OSCAR1A/10M/FMEF/S/S/31	5G/4G, LoRa, SigFox ISM Omnidirectional Wall Mount Antenna FME Female Connector 10M Cable
OSCAR1A/5M/SMAM/S/S/31	5G/4G, LoRa, SigFox ISM Omnidirectional Wall Mount Antenna SMA Male Connector 5M Cable
OSCAR1A/10M/SMAM/S/S/31	5G/4G, LoRa, SigFox ISM Omnidirectional Wall Mount Antenna SMA Male Connector 10M Cable
OSCAR1A/20M/SMAM/S/S/31	5G/4G, LoRa, SigFox ISM Omnidirectional Wall Mount Antenna SMA Male Connector 20M Cable

Registered in England No. 08405712
VAT Registration No. GB163 04 0349

[Download Latest Edition](#)



Siretta Ltd
Basingstoke Road
Spencers Wood
Reading
Berkshire RG7 1PW

sales
email
web

+44 118 796 9000
sales@siretta.com
www.siretta.com

Rev 3.1