



POWERPLUS DC SERIES | 100 VDC

PANEL MOUNT SOLID STATE RELAYS



Features

- Ratings from 10 A to 100 A @ 100 VDC
- LED Status Indicator
- Relays are easily paralleled for higher-current applications
- UL Approved, CE Compliant to EN60950-1
- Improved SEMS screw and washer
- Redesigned housing with anti-rotation barriers
- MOSFET Output
- DC control
- EMC Compliant to Level 3
- Epoxy Free Design
- Optional IP20 Cover
- PWM up to 1 kHz

PRODUCT SELECTION

Control Voltage	10 A	20 A	40 A	60 A	80 A	100 A
4-32 VDC	DC100D10	DC100D20	DC100D40	DC100D60	DC100D80	DC100D100

SPECIFICATIONS

Output Voltage ⁽¹⁾

Description	10 A	20 A	40 A	60 A	80 A	100 A
Recommended Operating Voltage [Vdc]	1-72	1-72	1-72	1-72	1-72	1-72
Absolute Maximum Rating [Vdc]	100	100	100	100	100	100
Maximum Off-State Leakage Current @ Rated Voltage [mA]	0.1	0.1	0.1	0.1	0.1	0.1
Maximum Load Current [Adc] ⁽²⁾⁽³⁾	10	20	40	60	80	100
Minimum Load Current [mA] ⁽⁴⁾	2.5	2.5	2.5	2.5	2.5	2.5
Maximum Surge Current (10msec) [Adc]	66	91	136	180	220	330
Maximum On-State Voltage Drop @ Rated Current [Vdc]	0.13	0.24	0.28	0.36	0.40	0.4
Maximum On-State Resistance [RDS-ON] [mΩ]	13	12	7	6	5	4
Thermal Resistance Junction to Case (Rjc) [°C/W]	1.27	0.73	0.58	0.45	0.34	0.27
Minimum Heat Sink for Rated Current @ 40°C [°C/W]	N/R	5	2	1	0.5	0.5
Maximum Pulse Width Modulation Frequency [Hz] ⁵	1000	1000	900	900	700	700

Input ⁽¹⁾

Description	DC Control
Control Voltage Range	4-32 VDC
Maximum Reverse Voltage	-32 VDC
Minimum Turn-On Voltage ⁽⁶⁾	4 VDC
Must Turn-Off Voltage	1 VDC
Minimum Input Current (for on-state)	11 mA
Maximum Input Current	14 mA
Nominal Input Impedance	Current Regulated
Maximum Turn-On Time [μsec]	75
Maximum Turn-Off Time [μsec]	150

General ⁽¹⁾

Description	Parameters
Dielectric Strength, Input/Output/Base (50/60 Hz)	3750 Vrms
Minimum Insulation Resistance (@ 500 VDC)	10 ⁹ Ohms
Maximum Capacitance, Input/Output	8 pF
Ambient Operating Temperature Range ⁽⁷⁾	-40 to 100 °C
Ambient Storage Temperature Range	-40 to 125 °C
Weight (typical)	2.53 oz (72 g)
Housing Material	UL94 V-0
Hardware Finish	Nickel Plating
Baseplate Material	Aluminum
Input Terminal Screw Torque Range (lb-in/Nm)	13-15 / 1.5-1.7
Load Terminal Screw Torque Range (lb-in/Nm)	18-20 / 2-2.2
SSR Mounting Screw Torque Range (lb-in/Nm)	18-20 / 2-2.2
Input/Load Terminal Screw Torque Range (lb-in/Nm) ⁽²⁾	w/"K" option 8-10 / 0.9-1.13
Input/Output Terminal Screw Thread Size	#6-32 UNC / #8-32 UNC
Humidity per IEC60068-2-78	85% non-condensing
LED Input Status Indicator	Green
MTBF (Mean Time Between Failures) at 40°C ambient temperature ⁽⁸⁾	21,395,130 hours (2,441 years)
MTBF (Mean Time Between Failures) at 60°C ambient temperature ⁽⁸⁾	11,545,504 hours (1,317 years)

WIRING DIAGRAM

* Inductive loads must be diode suppressed.

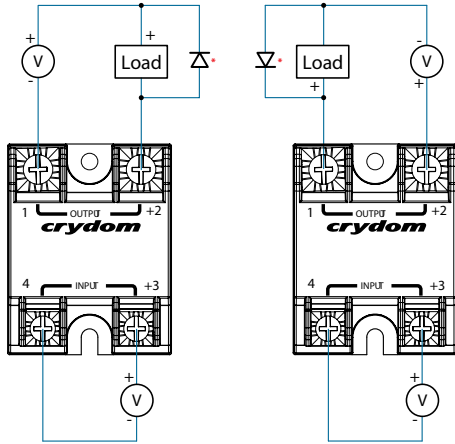

Recommended Wire Sizes		
Terminals	Wire Size (Solid / Stranded)	Wire Pull-Out Strength (lb)[N]
Input	24 AWG (0.2 mm ²) / 0.2 [minimum]	10 [44.5]
	2 x 12 AWG (3.3 mm ²) / 3.3 [maximum]	90 [400]
Output	20 AWG (0.5 mm ²) / 0.518 [minimum]	30 [133]
	2 x 10 AWG (5.3 mm ²) / 5.3	110 [490]
	2 x 8 AWG (8.4 mm ²) / 8.4 [maximum]	90 [400]

EQUIVALENT CIRCUIT BLOCK DIAGRAMS

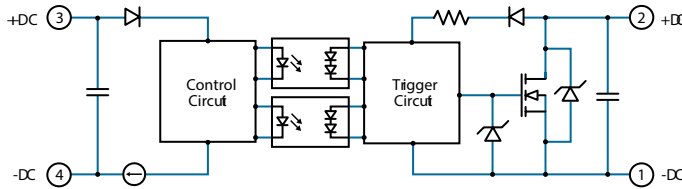

Input Current vs Input Voltage
Standard Regulated "DC" Inputs

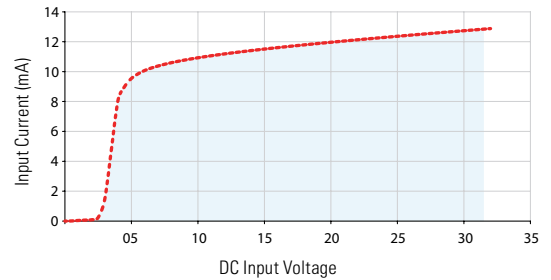

MECHANICAL SPECIFICATIONS (1)

*Tolerances: ±0.02 in / 0.5 mm All dimensions are in: inches [millimeters]

Screw Termination

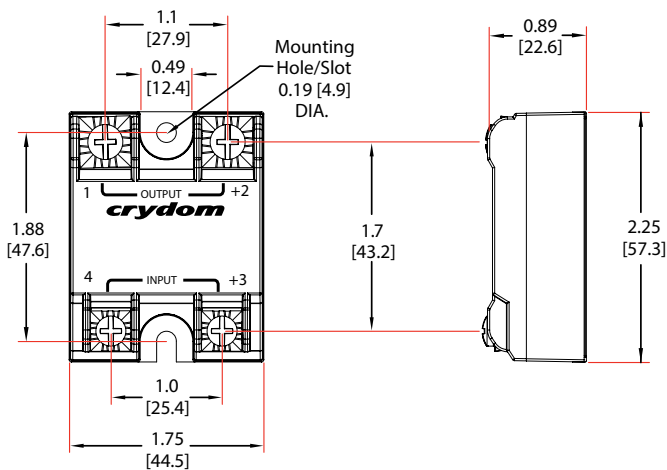

Hex Standoff Termination ("K" Option) (2)

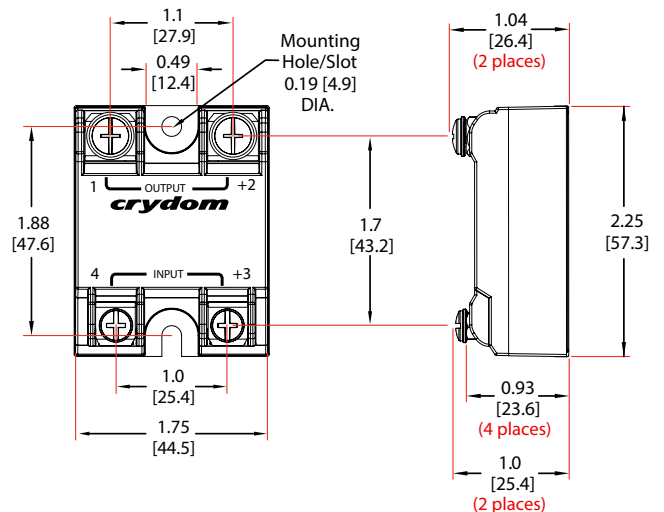

Screw Termination, IP20

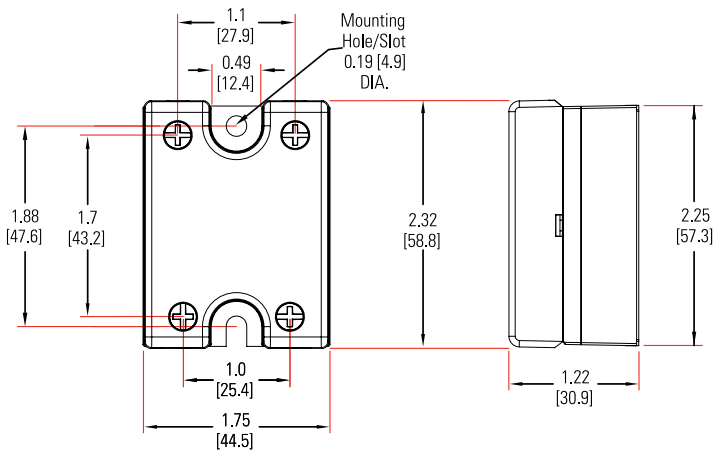

SURGE CURRENT INFORMATION

--- Single Pulse (i) --- Duty Factor (10%) (ii) --- Duty Factor (20%) (ii) --- Duty Factor (50%) (ii)

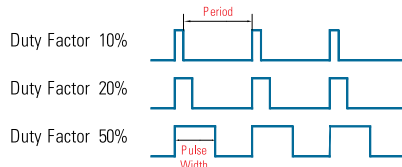
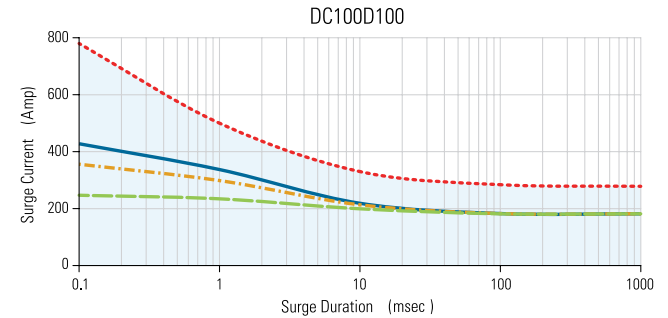
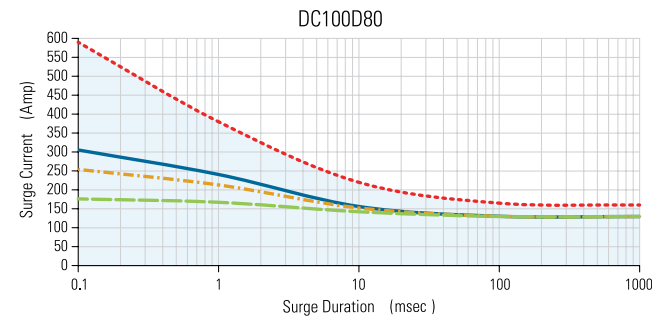
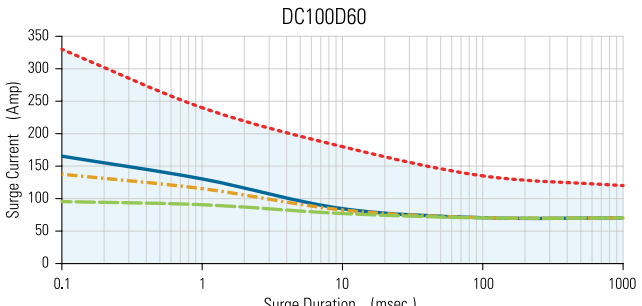
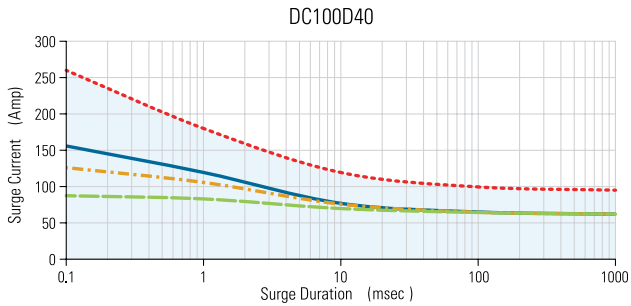
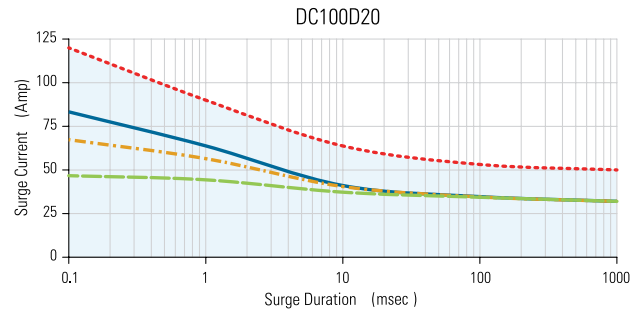
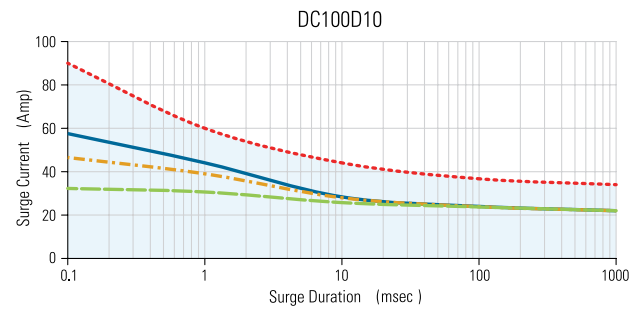

For Pulse Width Modulation applications select the curve according duty factor and pulse duration as following.

$$\text{Duty Factor} = \frac{\text{Pulse Width}}{\text{Period}} \times 100 (\%)$$



(i) for Single Surge Pulse $T_c=40^\circ\text{C}; T_j 175^\circ\text{C}$
 (ii) for Repetitive Surge Pulse $T_c=40^\circ\text{C}; T_j 130^\circ\text{C}$

THERMAL DERATE INFORMATION

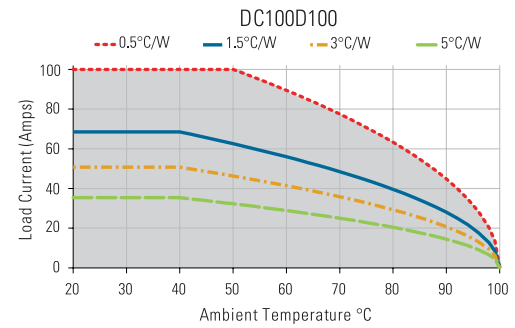
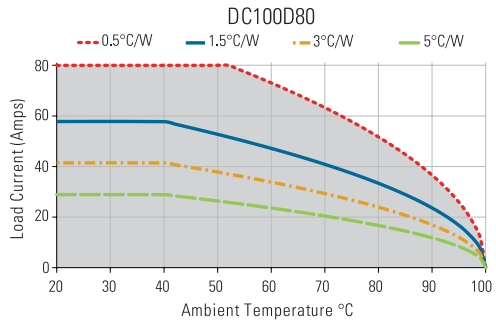
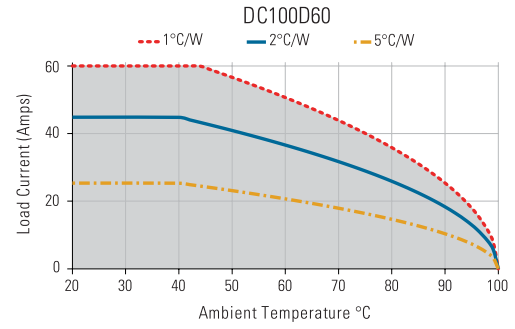
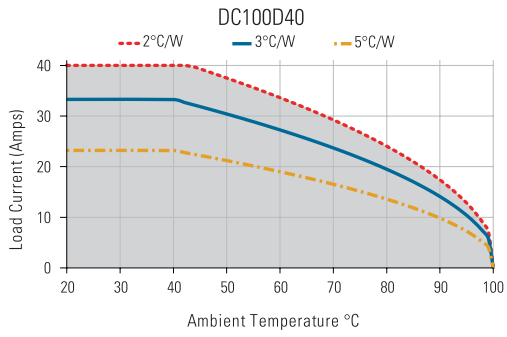
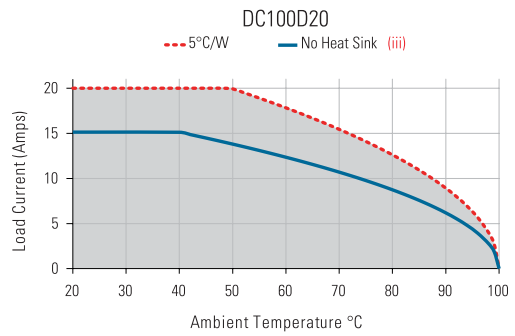
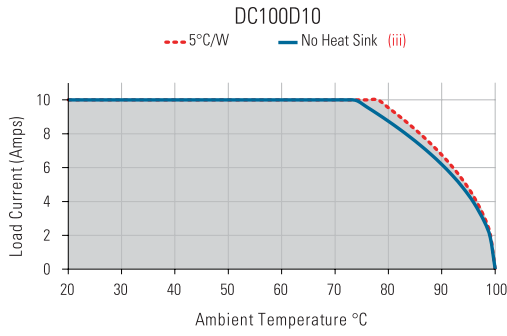
(iii) SSR metal base plate acting as heat sink, it must be exposed to free ambient air.

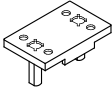

ACCESSORIES

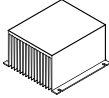
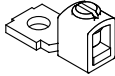
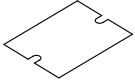
Recommended Accessories					
					
Cover	Hardware Kit	Heat Sink Part No.	Thermal Resistance [°C/W]	Lug Terminal	Thermal Pad
KS101	HK1 HK4	HS501DR HS301 / HS301DR HS251 HS201 / HS201DR HS202 / HS202DR HS172 HS151 / HS151DR HS122 / HS122DR HS103 / HS103DR HS101 HS073 HS072 HS053 HS033 HS023	5.0 3.0 2.5 2.0 2.0 1.7 1.5 1.2 1.0 1.0 0.7 0.7 0.5 0.36 0.25	TRM1 TRM6	HSP-1 HSP-2

ORDERING OPTIONS

Example : DC100D40CH

Not all part number combinations are available.
Contact Technical Support for information on the availability of a specific part number.

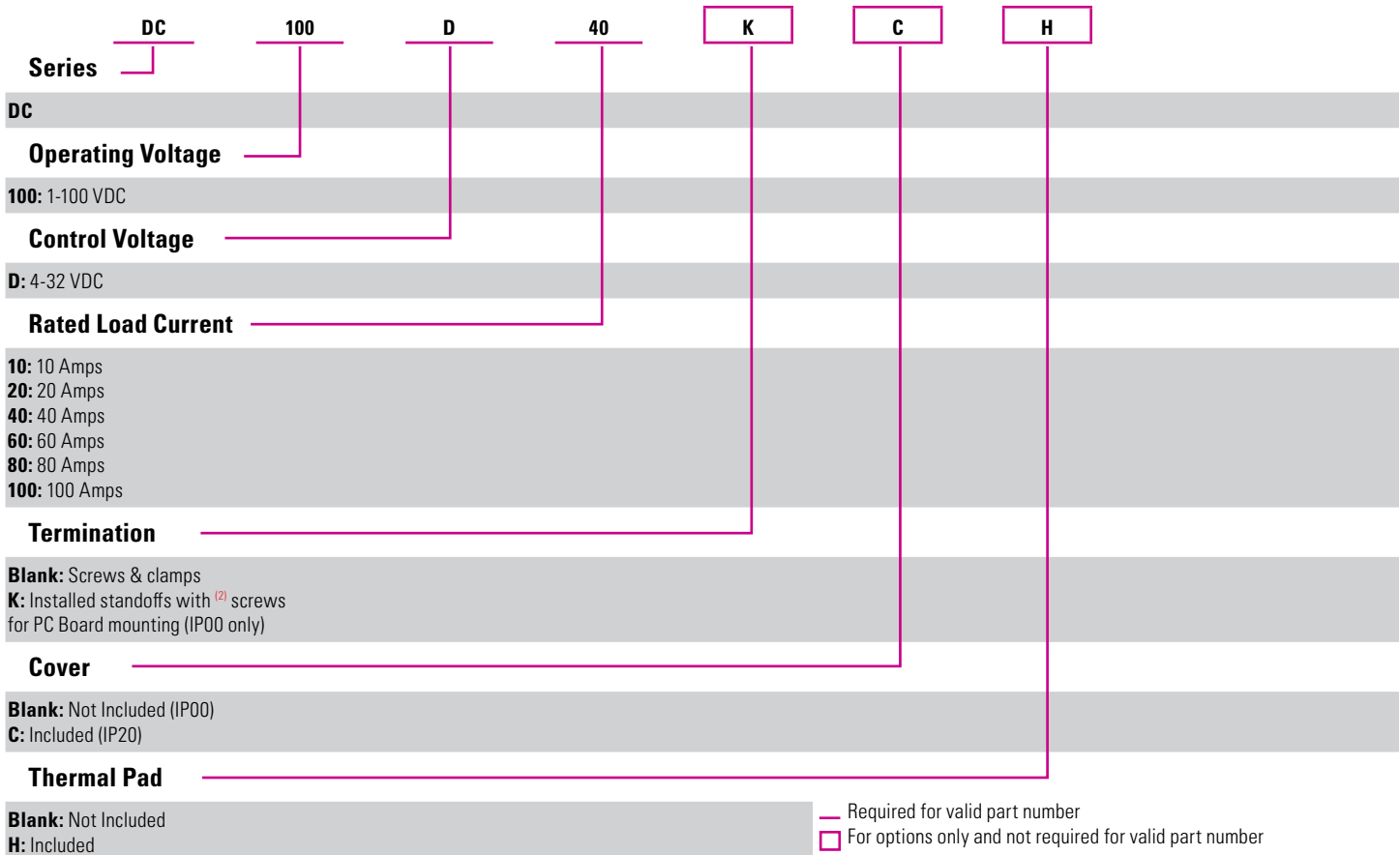

GENERAL NOTES

- (1) All parameters at $T_c=25^{\circ}\text{C}$ unless otherwise specified.
- (2) Option "K" is designed and tested for use with printed circuit boards or ring/fork terminals having a thickness between 0.031 and 0.093 inches (0.79 to 2.36 mm), and loads rated up to 50 Amps.
For higher load currents, the "K" standoff temperature must not exceed 105°C . For additional application assistance please contact Technical Support.
- (3) Heat sinking required, see derating curves.
- (4) Low current loads and high ambient temperature can affect turn-on time.
- (5) 8 VDC Minimum control voltage. Resistive loads only. Consider switching losses; at maximum frequency reduce to 75% output current.
- (6) Increase minimum voltage by 1V for operations from -20 to -40°C .
- (7) Decrease maximum control voltage $1.35\text{V}/^{\circ}\text{C}$ above 80°C ambient temperature.
- (8) All parameters at 50% power rating and 100% duty cycle.

For additional information or specific questions, contact Technical Support

AGENCY APPROVALS & CERTIFICATIONS

EN60950-1: Meets the requirements of sections 1.5: 1.7: 2.9: 2.10.5.3: 4.2: 4.5: 4.7:
IEC 61000-4-2 Electrostatic Discharge Level 3
IEC 61000-4-4 Electrically Fast Transients Level 3
IEC 61000-4-5 Electrical Surges Level 3



WARNINGS



RISK OF MATERIAL DAMAGE AND HOT ENCLOSURE

- The product's side panels may be hot, allow the product to cool before touching
- Follow proper mounting instructions including torque values
- Do not allow liquids or foreign objects to enter this product

Failure to follow these instructions can result in serious injury, or equipment damage.



HAZARD OF ELECTRIC SHOCK, EXPLOSION OR ARC FLASH

- Disconnect all power before installing or working with this equipment
- Verify all connections and replace all covers before turning on power

Failure to follow these instructions will result in death or serious injury.

Datasheets provided by Sensata Technologies, Inc., its subsidiaries and/or affiliates ("Sensata") are solely intended to assist third parties ("Buyers") who are developing systems that incorporate Sensata products (also referred to herein as "components"). Buyer understands and agrees that Buyer remains responsible for using its independent analysis, valuation, and judgment in designing Buyer's systems and products. Sensata datasheets have been created using standard laboratory conditions and engineering practices. Sensata has not conducted any testing other than that specifically described in the published documentation for a particular datasheet. Sensata may make corrections, enhancements, improvements, and other changes to its datasheets or components without notice.

Buyers are authorized to use Sensata datasheets with the Sensata component(s) identified in each particular datasheet. HOWEVER, NO OTHER LICENSE, EXPRESS OR IMPLIED, BY ESTOPPEL OR OTHERWISE TO ANY OTHER SENSATA INTELLECTUAL PROPERTY RIGHT, AND NO LICENSE TO ANY THIRD PARTY TECHNOLOGY OR INTELLECTUAL PROPERTY RIGHT, IS GRANTED HEREIN. SENSATA DATASHEETS ARE PROVIDED "AS IS". SENSATA MAKES NO WARRANTIES OR REPRESENTATIONS WITH REGARD TO THE DATASHEETS OR USE OF THE DATASHEETS, EXPRESS, IMPLIED, OR STATUTORY, INCLUDING ACCURACY OR COMPLETENESS. SENSATA DISCLAIMS ANY WARRANTY OF TITLE AND ANY IMPLIED WARRANTIES OF MERCHANTABILITY, FITNESS FOR A PARTICULAR PURPOSE, QUIET ENJOYMENT, QUIET POSSESSION, AND NON-INFRINGEMENT OF ANY THIRD PARTY INTELLECTUAL PROPERTY RIGHTS WITH REGARD TO SENSATA DATASHEETS OR USE THEREOF.

All products are sold subject to Sensata's terms and conditions of sale supplied at www.sensata.com. SENSATA ASSUMES NO LIABILITY FOR APPLICATIONS ASSISTANCE OR THE DESIGN OF BUYERS' PRODUCTS. BUYER ACKNOWLEDGES AND AGREES THAT IT IS SOLELY RESPONSIBLE FOR COMPLIANCE WITH ALL LEGAL, REGULATORY, AND SAFETY-RELATED REQUIREMENTS CONCERNING ITS PRODUCTS, AND ANY USE OF SENSATA COMPONENTS IN ITS APPLICATIONS, NOTWITHSTANDING ANY APPLICATIONS-RELATED INFORMATION OR SUPPORT THAT MAY BE PROVIDED BY SENSATA.

Mailing Address: Sensata Technologies, Inc., 529 Pleasant Street, Attleboro, MA 02703, USA

CONTACT US

Americas

+1(800) 350 2727
sales.crydom@sensata.com
Europe, Middle East & Africa
+44 (1202) 416170
ssr-info.eu@sensata.com

Asia Pacific

sales.isasia@list.sensata.com
China +86 (21) 2306 1500
Japan +81 (45) 277 7117
Korea +82 (31) 601 2004
India +91 (80) 67920890
Rest of Asia +886 (2) 27602006
ext 2808