



LPWA 450 MHz FPC ANTENNAS

FEATURES & BENEFITS

- 450 MHz FPC antennas for LPWA and other IoT products
- Available cable lengths: 100 mm & 150 mm
- Available connectors: MHF-type and MHF4-type
- FPC with double side adhesive tape simplifies mounting within the device even on curved areas
- Omnidirectional coverage

PART NUMBERS

PART NUMBER	CABLE LENGTH(A)		CONNECTOR TYPE (ON CABLE)
	MM	INCH	
L000606-02	100	3.93	MHF-TYPE PLUG
L000606-03	150	5.90	MHF-TYPE PLUG
L000606-05	100	3.93	MHF4L-TYPE PLUG
L000606-06	150	5.90	MHF4L-TYPE PLUG

LPWA 450 MHz FPC ANTENNAS

Standard Antenna Solutions

SPECIFICATIONS (Shown as L000606-2 : Others can vary with different cable lengths.)

Frequency Range (MHz)	450-467 MHz
VSWR	< 2.2:1
Average Efficiency	47%
Peak Gain	1.04 dBi
Average Gain	0.78 dBi
Power Handling	10 Watt cw
Feed Point Impedance	50 ohms
Polarization	Linear
Size	92.5 mm x 20 mm x 0.152 mm
Weight	< 1 g
Mounting	Adhesive
Mating Connectors	MHF1 and MHF4 type
Cable	1.13mm Dia.
Operating Temperature	-40 to +85°C
Hazardous Materials	A certificate of conformance is available from the product page on TE website.

RF DATA (Shown as L000606-2 : Others can vary with different cable lengths.)

VSWR

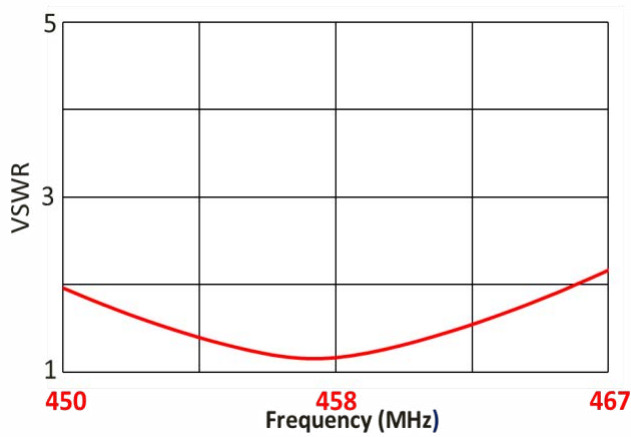

Return Loss

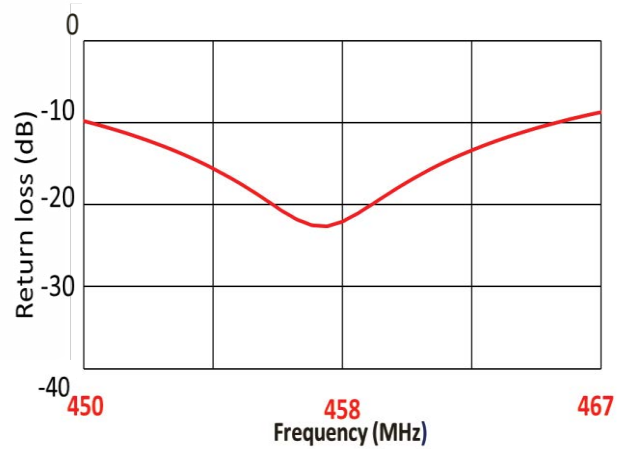

Peak Gain

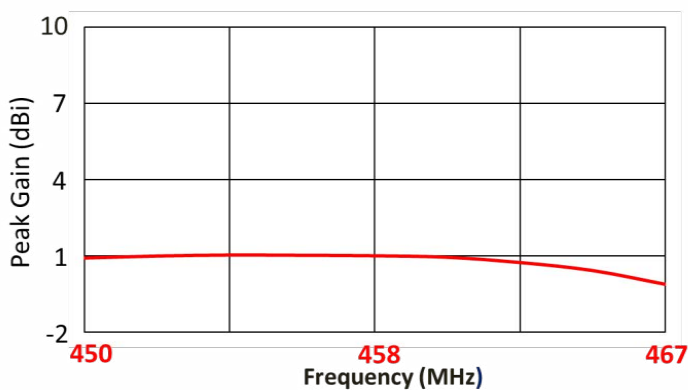

Efficiency

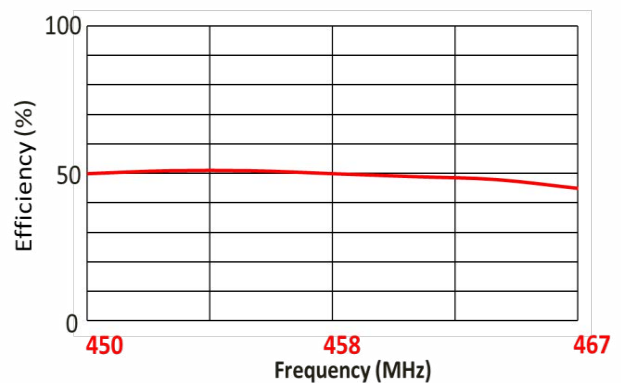

Data measured on 1.7mm thick PC plastic with reference evaluation board and matching circuit. Application data might vary.

ANTENNA RF SPECIFICATIONS WITH DIFFERENT CABLE ASSEMBLIES

Cable Length / Cable OD 1.13 mm	RF DATA	Frequency Range (MHz)
		450 - 467
50 mm	VSWR	< 2.2:1
	Avg. Efficiency	47%
	Peak Gain (Max)	1.04 dBi
	Average Gain	0.78 dBi
100 mm	VSWR	< 2.64:1
	Avg. Efficiency	29.2 %
	Peak Gain (Max)	-1.01 dBi
	Average Gain	-1.47 dBi

Data measured on 1.7mm thick PC plastic with reference evaluation board and matching circuit. Application data might vary.

RADIATION PATTERN

Test setup

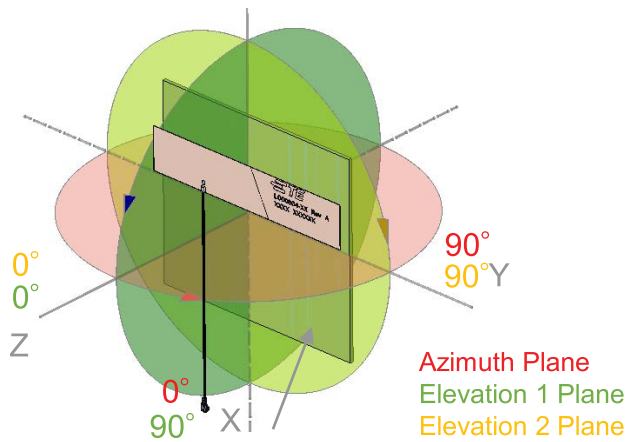

Plastic device enclosure

Azimuth

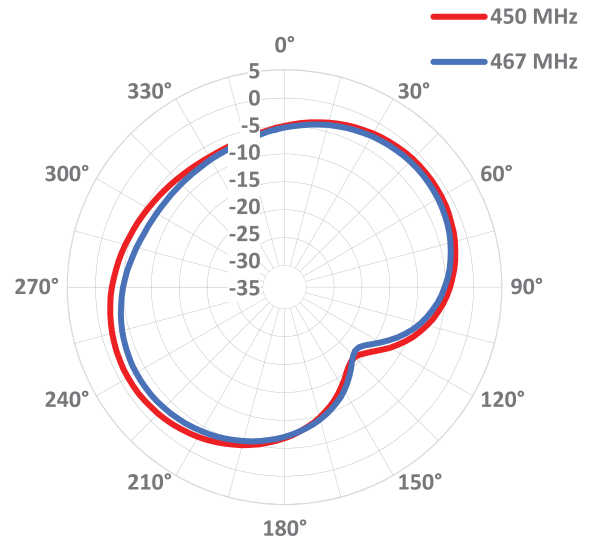

Elevation

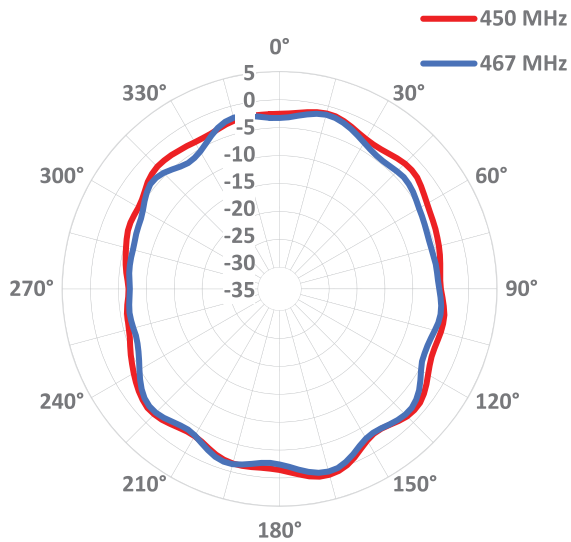

Elevation 2

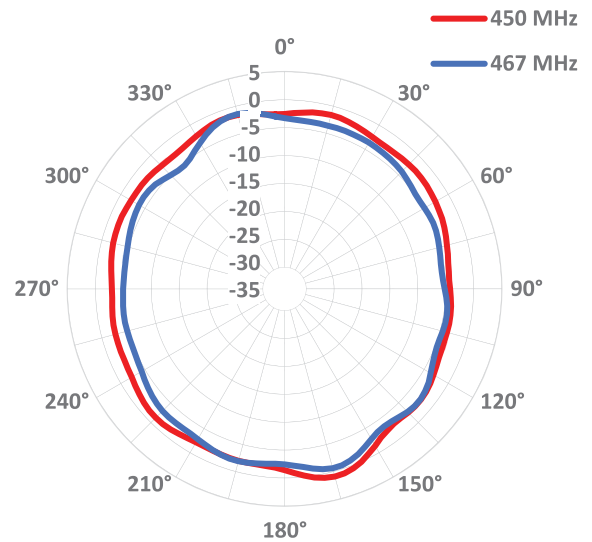

Data measured on 1.7mm thick PC plastic with reference evaluation board and matching circuit. Application data might vary.

EVALUATION BOARD MATCHING NETWORK LAYOUT

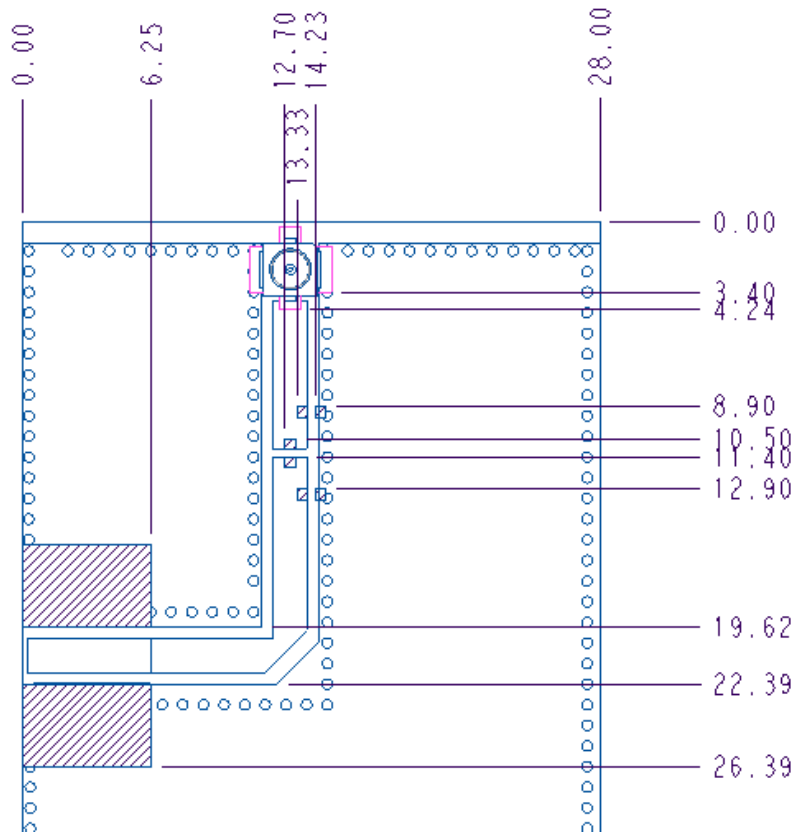

NOTES

1. Antenna is connected to evaluation board with MHF
2. Measured with below matching circuit condition.
3. Reference PCB Dimension(mm) - 28 x 103 x 1.6mm
4. NC = Non connection (mechanical mounting pads).
5. For more information please contact TE.

Dimension: mm

Diagram is not to scale

P/N	Matching Network		
	1	2	3
L000606-02	NC	4.7pF	NC
L000606-03	22nH	4pF	NC

KEEP OUT AREA

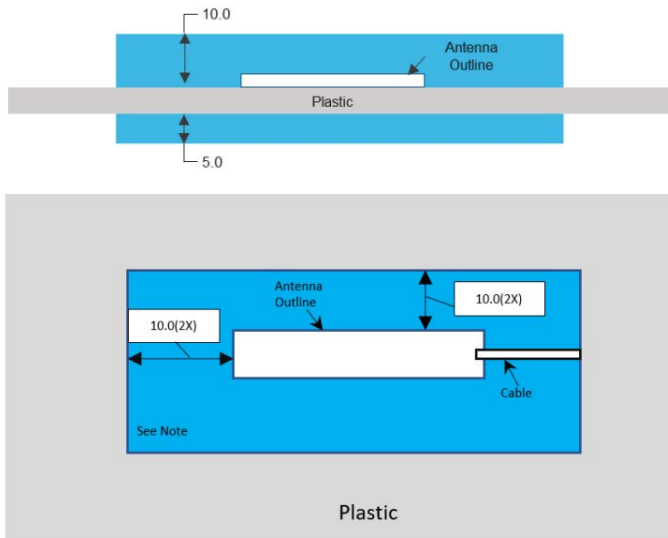

NOTES

1. Antenna designed to be mounted on plastic cover.
2. Area in blue indicates Keep Out Area
3. Contact TE if Keep Out Area cannot be guaranteed.

Dimension: mm

Diagram is not to scale

DIMENSIONS

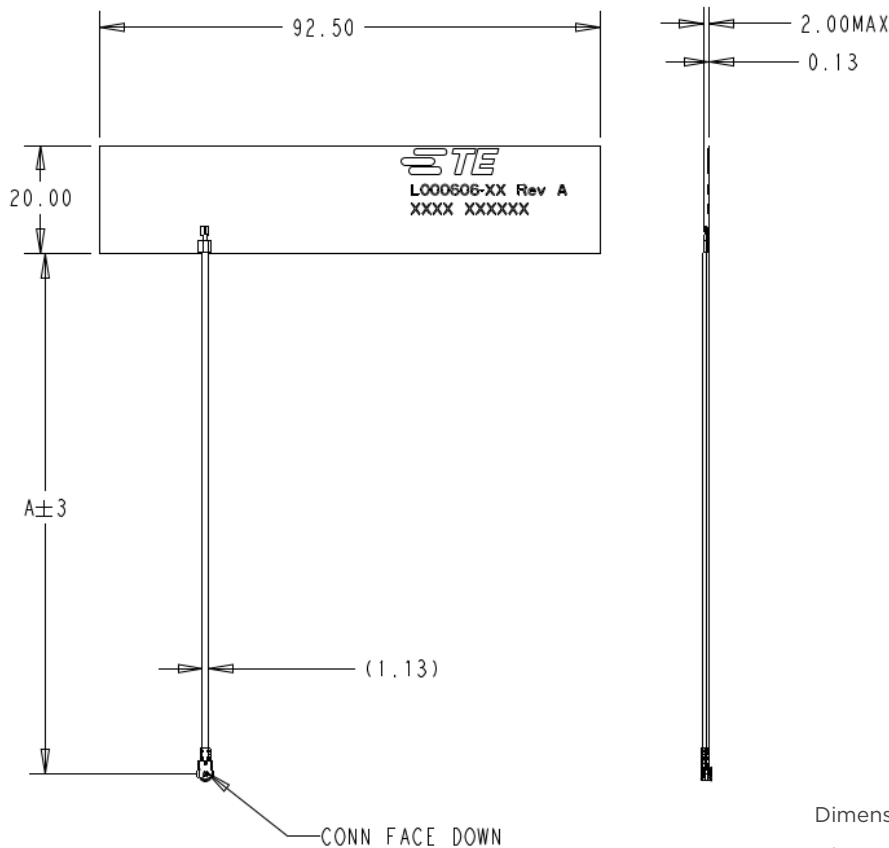

(Refer to Page 6 for dimension "A")



Dimension: mm

Diagram is not to scale

MATING COMPONENTS TO PART NUMBERS AND DIMENSIONS

PART NUMBER	CABLE LENGTH(A)		CABLE O.D, MM	CONNECTOR TYPE (ON CABLE)	PART NUMBER MATING COMPONENTS	IMAGE
	MM	INCH				
L000606-02	100	3.93	1.13	MHF-TYPE PLUG	RECEPTACLE (TE PN: 2337019-1)	
L000606-03	150	5.90	1.13	MHF-TYPE PLUG	RECEPTACLE (TE PN: 2337019-1)	
L000606-05	100	3.93	1.13	MHF4L-TYPE PLUG	RECEPTACLE (TE PN: 2334884-1)	
L000606-06	150	5.90	1.13	MHF4L-TYPE PLUG	RECEPTACLE (TE PN: 2334884-1)	

PACKAGING

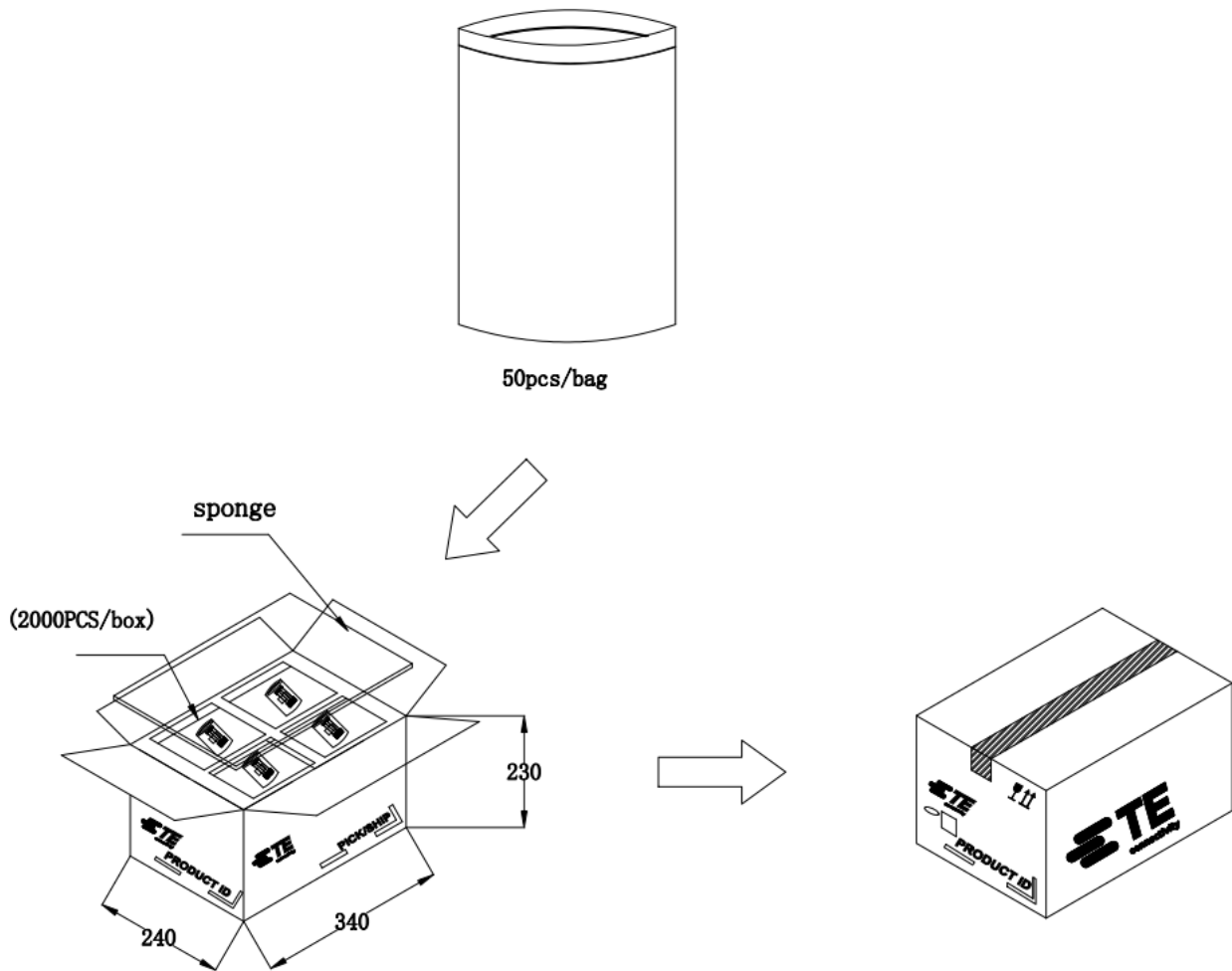

LPWA 450 MHz FPC ANTENNAS

Standard Antenna Solutions

TE TECHNICAL SUPPORT CENTER

USA:	+1 (800) 522-6752
Canada:	+1 (905) 475-6222
Mexico:	+52 (0) 55-1106-0800
Latin/S. America:	+54 (0) 11-4733-2200
Germany:	+49 (0) 6251-133-1999
UK:	+44 (0) 800-267666
France:	+33 (0) 1-3420-8686
Netherlands:	+31 (0) 73-6246-999
China:	+86 (0) 400-820-6015

For phone numbers in other countries, go to te.com/support-center

te.com

TE, TE Connectivity and TE connectivity (logo) are trademarks owned or licensed by the TE Connectivity Ltd. family of companies. Other product names, logos, and company names mentioned herein may be trademarks of their respective owners.

The information given herein, including drawings, illustrations and schematics which are intended for illustration purposes only, is believed to be reliable. However, TE Connectivity makes no warranties as to its accuracy or completeness and disclaims any liability in connection with its use. TE Connectivity's obligations shall only be as set forth in TE Connectivity's Standard Terms and Conditions of Sale for this product and in no case will TE Connectivity be liable for any incidental, indirect or consequential damages arising out of the sale, resale, use or misuse of the product. Users of TE Connectivity products should make their own evaluation to determine the suitability of each such product for the specific application.

©2024 TE Connectivity. All Rights Reserved.

Published 06-24