

Part No. CS1206KKX7RBBB102

| 1206 (3216) | X7R | 500 Vdc | 1 nF | ±10% |

Surface-Mount Ceramic Multilayer Capacitors (RoHS compliant & Halogen Free)

■ Appearance

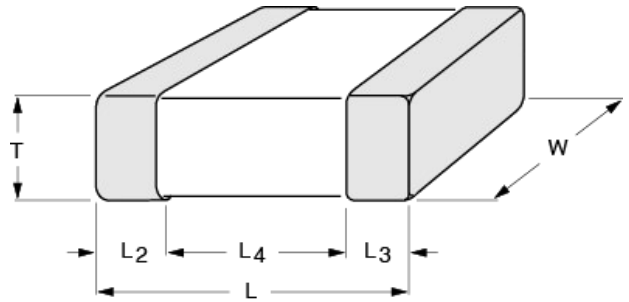
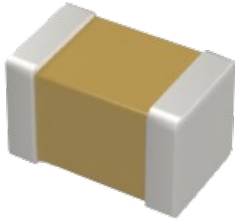

■ Dimension (mm)

L (Length)	3.20 ±0.40
W (width)	1.60 ±0.20
T (Thickness)	1.25 ±0.20
L2/L3	0.25~0.85
L4	1.5

■ Specification

Application	Boardflex Sensitive
Case Size (EIA/JIS)	1206 (3216)
Temperature Characteristic	X7R
Operation Temp. Range	-55 to +125°C
Capacitance	1 nF
Capacitance Tolerance	±10%
Rated Voltage (VDC)	500
Endurance (% Rated voltage)	120%
Tanδ (max)	2.50%
Insulation Resistance (min)	10 GΩ
Packing	Embossed Plastic Tape Reel 7 inch
Standard Packing Qty (pcs)	3,000
Test Method	IEC-60384

The data are for reference only. Electrical characteristics vary depending on environment or measurement condition.

YAGEO reserves the right to make change to the data at any time without notice. Before making final selection, please check product specification.

Part No. CS1206KKX7RBBB102

| 1206 (3216) | X7R | 500 Vdc | 1 nF | ±10% |

Surface-Mount Ceramic Multilayer Capacitors (RoHS compliant & Halogen Free)

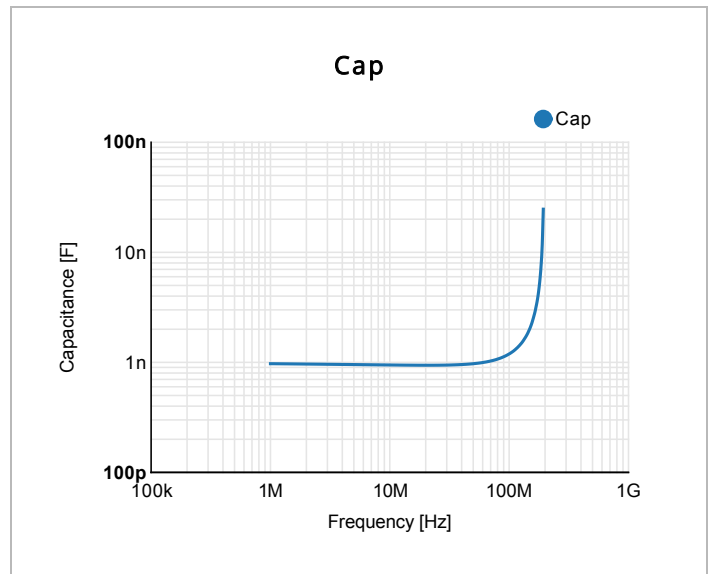
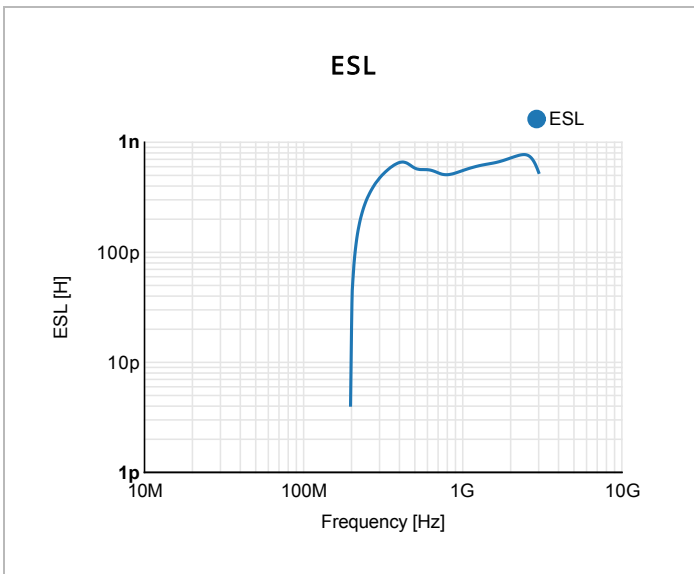
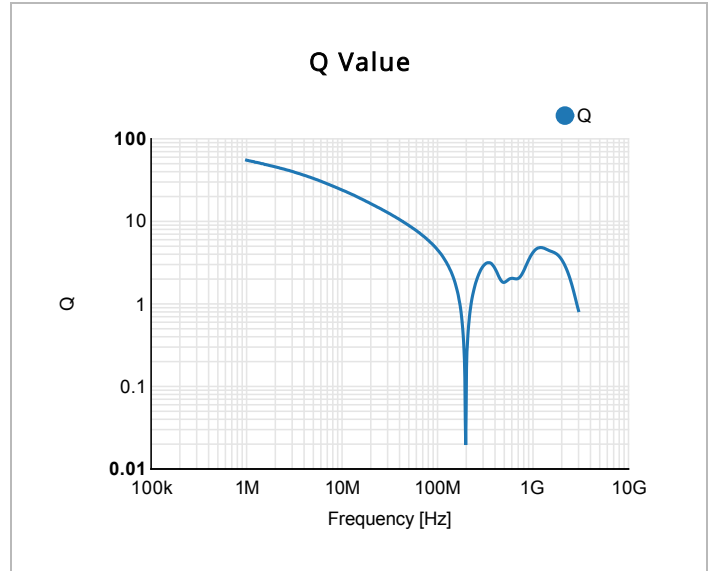
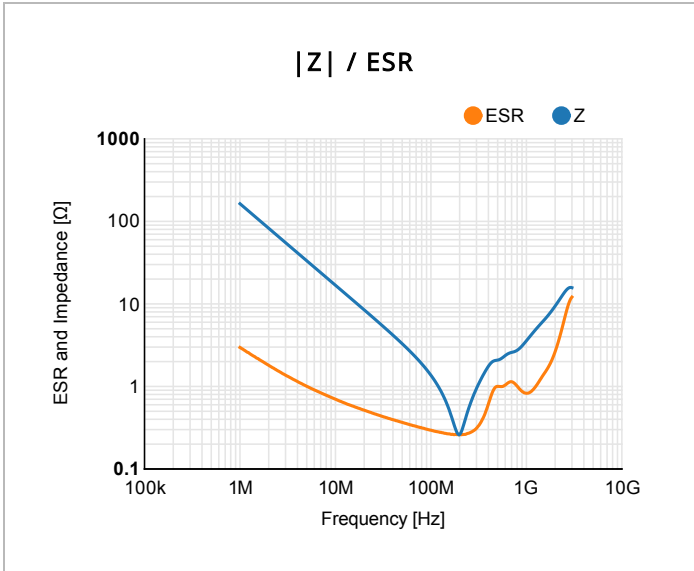

The data are for reference only. Electrical characteristics vary depending on environment or measurement condition. YAGEO reserves the right to make change to the data at any time without notice. Before making final selection, please check product specification.

Part No. CS1206KKX7RBBB102

| 1206 (3216) | X7R | 500 Vdc | 1 nF | ±10% |

Surface-Mount Ceramic Multilayer Capacitors (RoHS compliant & Halogen Free)

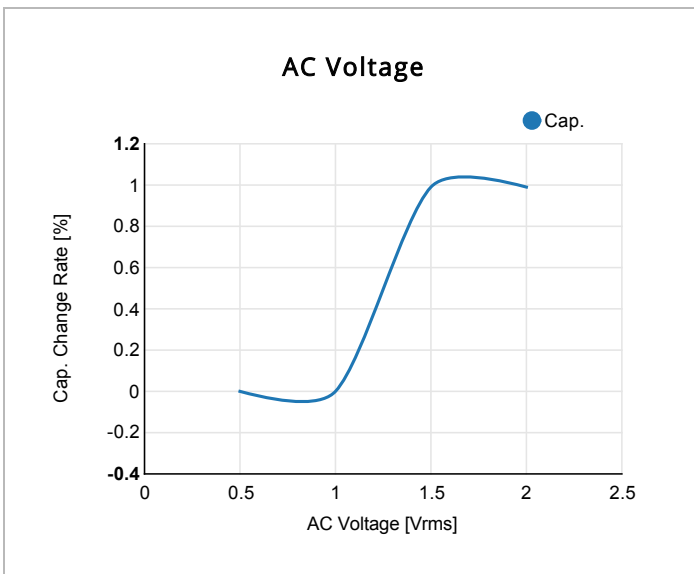
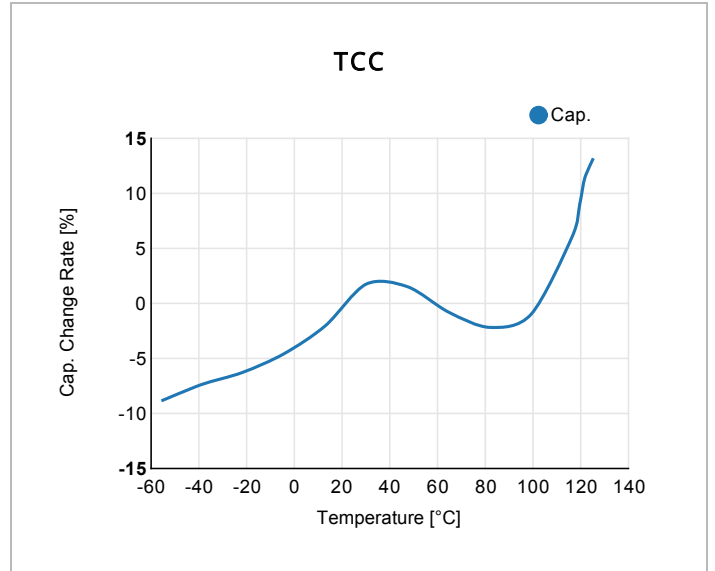
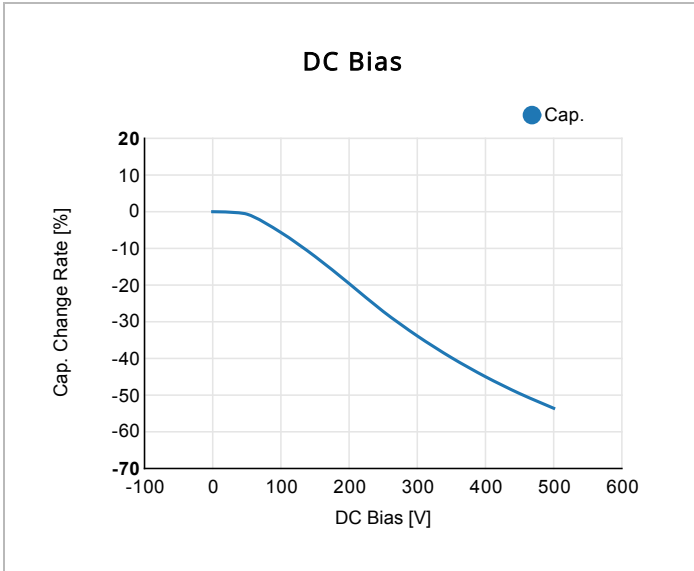

The data are for reference only. Electrical characteristics vary depending on environment or measurement condition. YAGEO reserves the right to make change to the data at any time without notice. Before making final selection, please check product specification.