

Automotive-grade ACEPACK DRIVE power module, sixpack topology 1200 V, 1.9 mΩ typ. SiC MOSFET gen.3 based

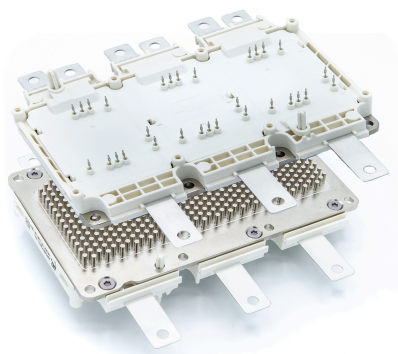

ACEPACK DRIVE

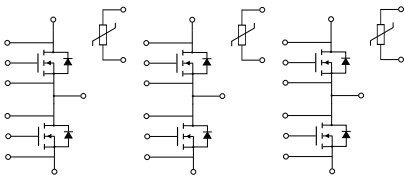

Features

- AQG 324 qualified 
- 1200 V blocking voltage
- 1.9 mΩ of typical $R_{DS(on)}$
- Maximum operative junction temperature $T_J = 175\text{ °C}$
- Very low switching energy
- Low inductive compact design for an higher power density
- Si_3N_4 AMB substrate to improve thermal performance
- SiC Power MOSFET chip sintered to substrate for improved lifetime
- 4.2 kV DC 1 s insulation
- Direct cooled Cu base plate with pin fins
- Three integrated NTC temperature sensors
- Long AC bus bar compatible with phase current sense

Application

- Main inverter (electric traction)

Description

The ACEPACK DRIVE is a compact sixpack module optimized for hybrid and electric vehicles traction inverter. This power module features switches based on silicon carbide Power MOSFET 3rd generation, are characterized by very low $R_{DS(on)}$, very limited switching losses and outstanding performances in synchronous rectification working mode. This will ensure superb efficiency in final application, saving battery recharging cycles.

A copper base plate with pin-fin base structure make direct fluid cooling available for this power module minimizing thermal resistance.

A dedicated pin-out has been developed to get the best switching performances and press-fit pins will ensure optimal connection with driving board.



Product status link

[ADP480120W3-L](#)

Product summary

Order code	ADP480120W3-L
Marking	ADP480120W3-L
Package	ACEPACK DRIVE
Leads type	Press fit
Packing	Tray

1 Electrical ratings

Table 1. Absolute maximum ratings of each switch

Symbol	Parameter	Value	Unit
$V_{(BR)DSS}$	Drain-source breakdown voltage	1200	V
V_{GS}	Gate-source voltage	-10 to 22	V
	Gate-source voltage (recommended operating values)	-5 to 18	
$I_D^{(1)}$	Continuous drain current at $T_F = 75\text{ °C}$ (refer to $T_J \text{ max} = 175\text{ °C}$, $V_{GS} = 18\text{ V}$)	488	A
$I_{DM}^{(2)}$	Repetitive peak drain current	1000	A
P_{TOT}	Total power dissipation at $T_F = 75\text{ °C}$ (refer to $T_J \text{ max} = 175\text{ °C}$, $V_{GS} = 18\text{ V}$)	869	W
T_J	Operating junction temperature range under switching conditions	-40 to 175 ⁽³⁾	°C

1. Specified by design, not tested in production.
2. Pulse width limited by maximum junction temperature.
3. Maximum baseplate temperature has to be always limited to 125 °C.

Table 2. Thermal data of each switch

Symbol	Parameter	Min.	Typ.	Max.	Unit
$R_{thJF}^{(1)}$	Thermal resistance, junction-to-fluid (flow rate = 10 LPM, $T_F = 75\text{ °C}$, single switch)	-	0.105	-	°C/W

1. Simulated value considering 50% water/ 50% ethylene glycol cooling fluid. Refer to TN1412 "ACEPACK DRIVE assembly instructions" for water jacket design

2 Electrical characteristics

$T_J = 25\text{ °C}$, unless otherwise specified.

Table 3. Electrical characteristics of each switch

Symbol	Parameter	Test conditions	Min.	Typ.	Max.	Unit
$R_{DS(on)}^{(1)}$	Static drain-source on-resistance	$V_{GS} = 18\text{ V}, I_D = 480\text{ A}$		1.90	2.60	mΩ
		$V_{GS} = 18\text{ V}, I_D = 480\text{ A}, T_J = 175\text{ °C}$		3.35		
		$V_{GS} = 18\text{ V}, I_D = -480\text{ A}$		1.70		
		$V_{GS} = 18\text{ V}, I_D = -480\text{ A}, T_J = 175\text{ °C}$		3.30		
$V_{GS(th)}$	Gate threshold voltage	$V_{DS} = V_{GS}, I_D = 50\text{ mA}$	1.9	3.1	4.4	V
I_{DSS}	Zero gate voltage drain current	$V_{GS} = 0\text{ V}, V_{DS} = 1200\text{ V}$			100	μA
		$V_{GS} = 0\text{ V}, V_{DS} = 1200\text{ V}, T_J = 150\text{ °C}^{(2)}$			2	mA
I_{GSS}	Gate-body leakage current	$V_{DS} = 0\text{ V}, V_{GS} = -10\text{ to }22\text{ V}$			2	μA
C_{iss}	Input capacitance	$V_{DS} = 800\text{ V}, f = 1\text{ MHz}, V_{GS} = 0\text{ V}$		37.42		nF
C_{oss}	Output capacitance			1.43		
C_{riss}	Reverse transfer capacitance			0.13		
Q_g	Total gate charge	$V_{DS} = 800\text{ V}, I_D = 480\text{ A},$ $V_{GS} = -5\text{ V to }18\text{ V}$		1258		nC
Q_{gs}	Gate-emitter charge			431		
Q_{gd}	Gate-collector charge			403		

- $R_{DS(on)}$ is referred to switch level.
- Specified by design, not tested in production.

Table 4. Switching energy of each switch

Symbol	Parameter	Test conditions	Min.	Typ.	Max.	Unit
$E_{on}^{(1)}$	Turn-on switching energy	$V_{DD} = 800\text{ V}, V_{GS} = -5\text{ to }18\text{ V},$ $di/dt_{on} = 4.2\text{ A/ns}, R_G = 10\text{ }\Omega,$ $I_D = 480\text{ A}$	-	42.3	-	mJ
		$V_{DD} = 800\text{ V}, V_{GS} = -5\text{ to }18\text{ V},$ $di/dt_{on} = 5.5\text{ A/ns}, R_G = 10\text{ }\Omega,$ $I_D = 480\text{ A}, T_J = 175\text{ °C}$	-	32.8	-	
E_{off}	Turn-off switching energy	$V_{DD} = 800\text{ V}, V_{GS} = -5\text{ to }18\text{ V},$ $dv/dt_{off} = 5.9\text{ V/ns}, R_G = 8.2\text{ }\Omega,$ $I_D = 480\text{ A}$	-	41.6	-	mJ
		$V_{DD} = 800\text{ V}, V_{GS} = -5\text{ to }18\text{ V},$ $dv/dt_{off} = 7.8\text{ V/ns}, R_G = 8.2\text{ }\Omega,$ $I_D = 480\text{ A}, T_J = 175\text{ °C}$	-	38.5	-	

- Using active Miller clamp circuit.

Table 5. Source-drain diode characteristics of each switch

Symbol	Parameter	Test conditions	Min.	Typ.	Max.	Unit
V_{SD}	Forward on voltage drop	$V_{GS} = -5\text{ V}$, $I_{SD} = 480\text{ A}$	-	4.4	-	V
t_{rr}	Reverse recovery time	$V_{DD} = 800\text{ V}$, $V_{GS} = -5\text{ to }18\text{ V}$, $R_G = 10\ \Omega$, $di/dt_{on} = 4.2\text{ A/ns}$, $I_{SD} = 480\text{ A}$	-	34	-	ns
Q_{rr}	Reverse recovery charge		-	2.5	-	μC
I_{RRM}	Reverse recovery current		-	128	-	A
E_{rec}	Reverse recovery energy		-	0.52	-	mJ
t_{rr}	Reverse recovery time	$V_{DD} = 800\text{ V}$, $V_{GS} = -5\text{ to }18\text{ V}$, $R_G = 10\ \Omega$, $di/dt_{on} = 5.5\text{ A/ns}$, $I_{SD} = 480\text{ A}$, $T_J = 175\text{ }^\circ\text{C}$	-	57	-	ns
Q_{rr}	Reverse recovery charge		-	6.6	-	μC
I_{RRM}	Reverse recovery current		-	195	-	A
E_{rec}	Reverse recovery energy		-	1.96	-	mJ

Note: Values are calculated taking in account an active Miller clamp circuit.

3 NTC

Table 6. Absolute maximum ratings for NTC temperature sensor, considered as stand-alone

Symbol	Parameter	Test condition	Min.	Typ.	Max.	Unit
R ₂₅	Rated resistance	T = 25 °C		5.0		kΩ
R ₁₀₀	Rated resistance	T = 100 °C		493		Ω
ΔR/R	Deviation of R ₁₀₀		-5		+5	%
B _{25/50}	B-constant			3375		K
B _{25/80}				3411		

4 ACEPACK DRIVE power module details

Table 7. Ratings for module

Symbol	Parameter		Value	Unit
V_{ISO}	Isolation voltage (f = 0 Hz, t = 1 s)		4.2	kV
	Internal isolation (class 1, IEC 61140)		Si_3N_4	
	Baseplate module material		Ni plated, Cu baseplate	
d_{creep}	Creepage distance	Terminal to heat sink	9.0	mm
		Terminal to terminal	9.0	
d_{clear}	Clearance distance	Terminal to heat sink	4.5	mm
		Terminal to terminal	4.5	
CTI	Comparative tracking index		>200	V
L_s	Typical stray inductance drain to source module loop		10	nH
R_s	Typical module lead resistance, terminals to chip		0.5	m Ω
T_{stg}	Storage temperature range		-40 to 125	$^{\circ}C$

5 Electrical characteristics (curves)

Figure 1. Typical output characteristics ($T_J = -40\text{ }^\circ\text{C}$)

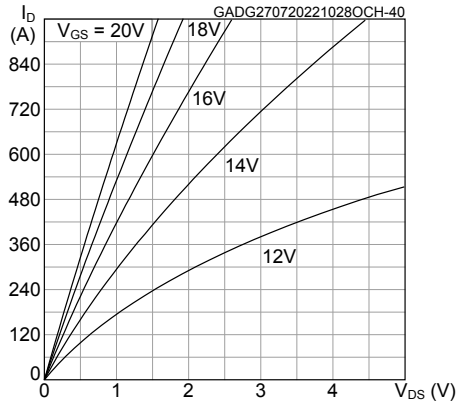

Figure 2. Typical output characteristics ($T_J = 25\text{ }^\circ\text{C}$)

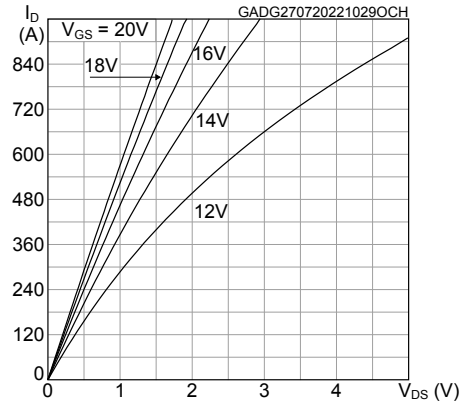

Figure 3. Typical output characteristics ($T_J = 175\text{ }^\circ\text{C}$)

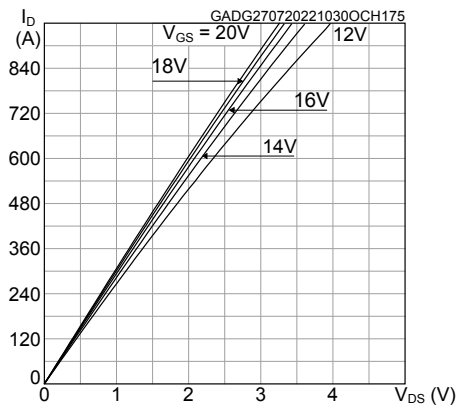

Figure 4. Typical reverse conduction characteristics ($T_J = -40\text{ }^\circ\text{C}$)

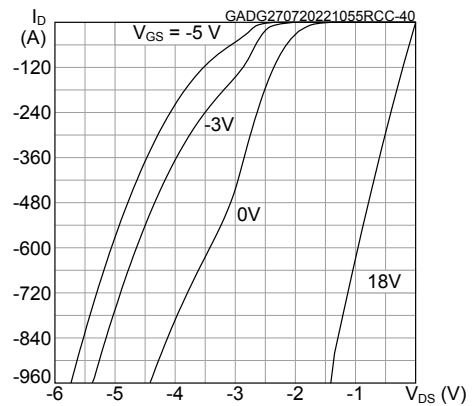

Figure 5. Typical reverse conduction characteristics ($T_J = 25\text{ }^\circ\text{C}$)

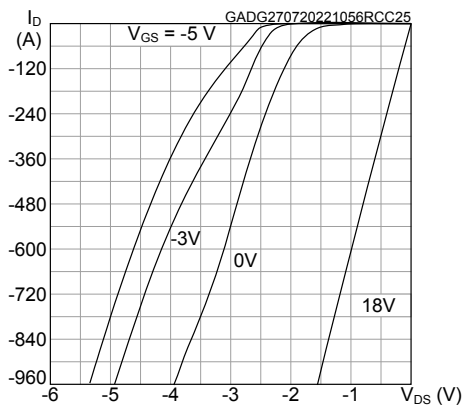

Figure 6. Typical reverse conduction characteristics ($T_J = 175\text{ }^\circ\text{C}$)

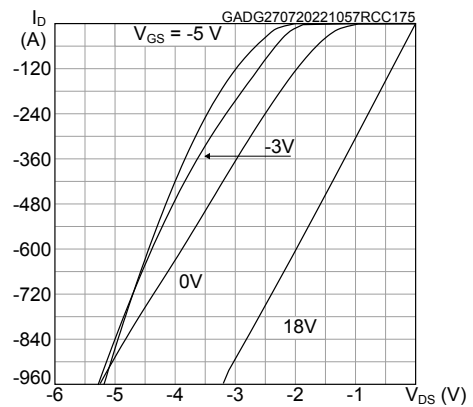

Figure 7. Typical transfer characteristics

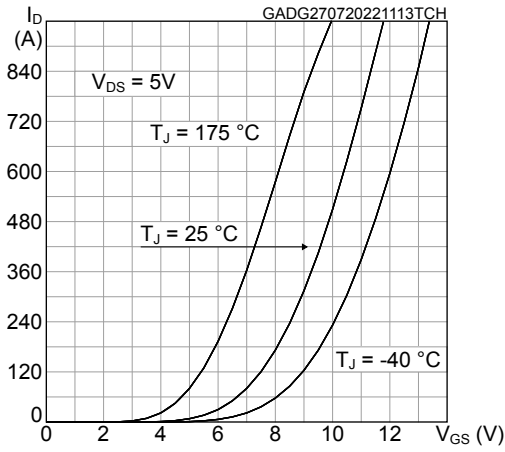

Figure 8. Normalized breakdown voltage vs temperature

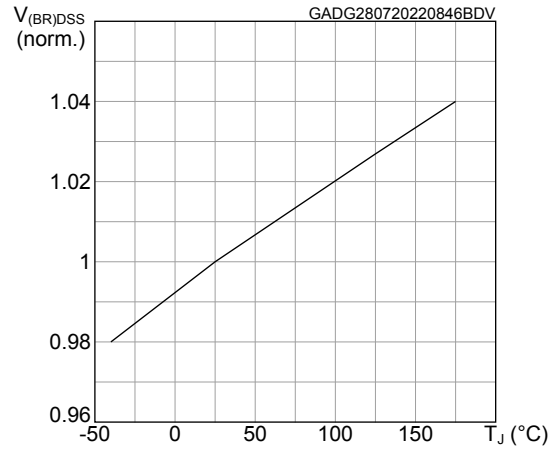

Figure 9. Typical switching energy vs drain current

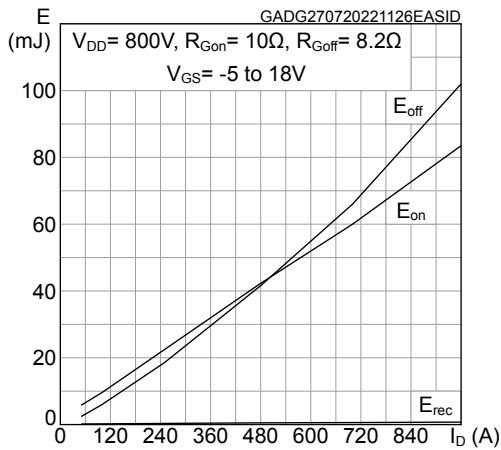

Figure 10. Typical switching energy vs gate resistance

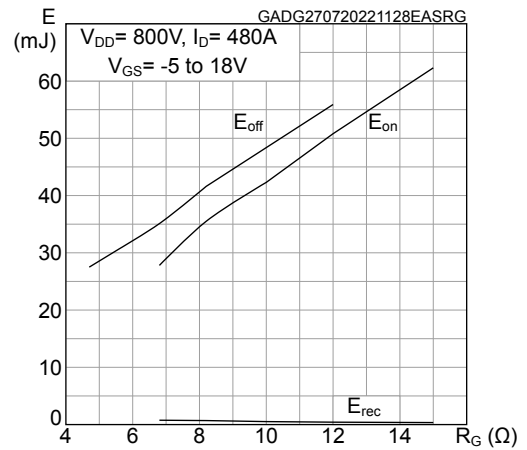

Figure 11. Typical switching energy vs temperature

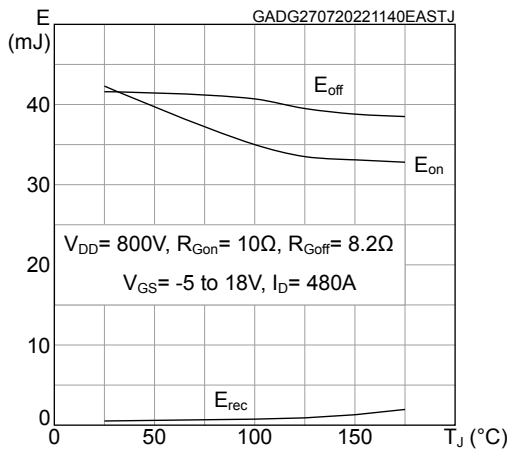

Figure 12. Typical switching energy vs bus voltage

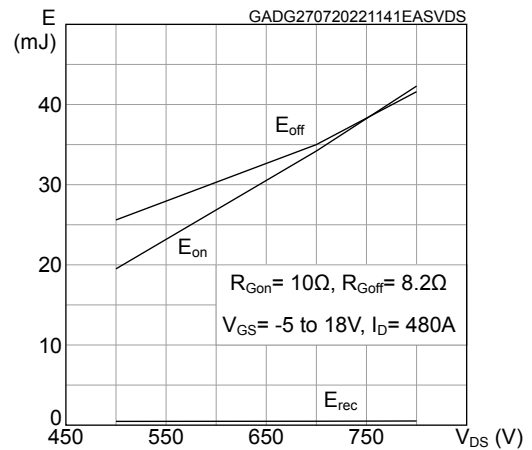

Figure 13. Typical capacitance characteristics

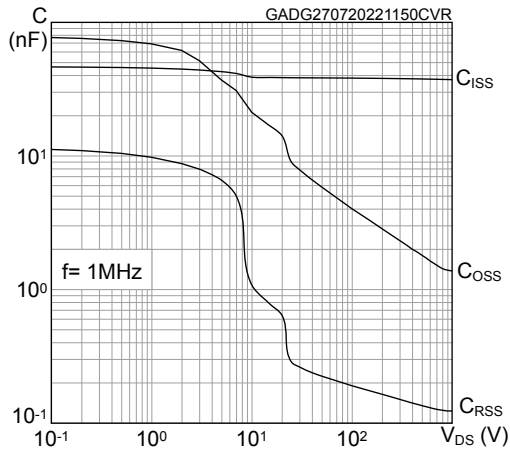

Figure 14. Typical gate charge characteristics

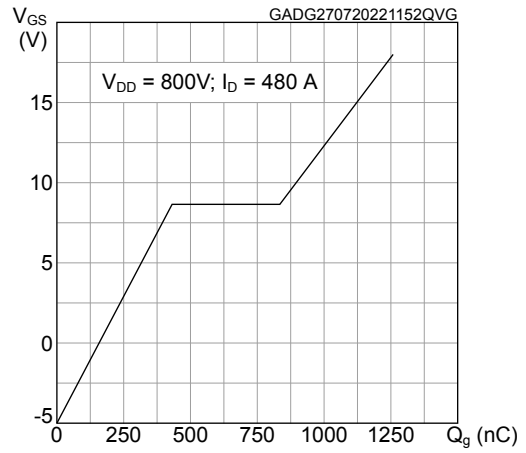

Figure 15. Typical transient thermal impedance

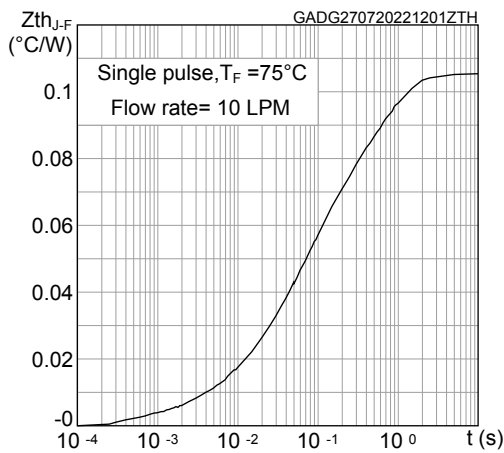

Figure 16. Typical thermal resistance vs flow rate

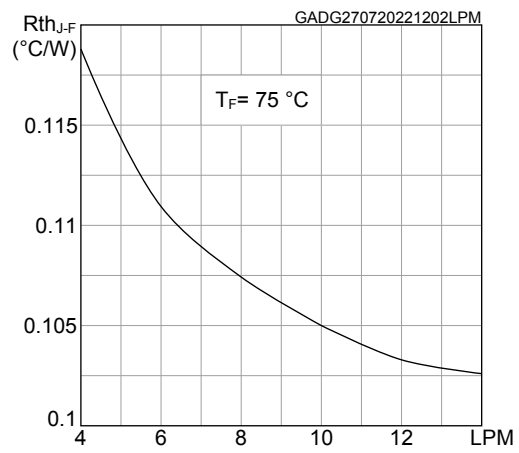
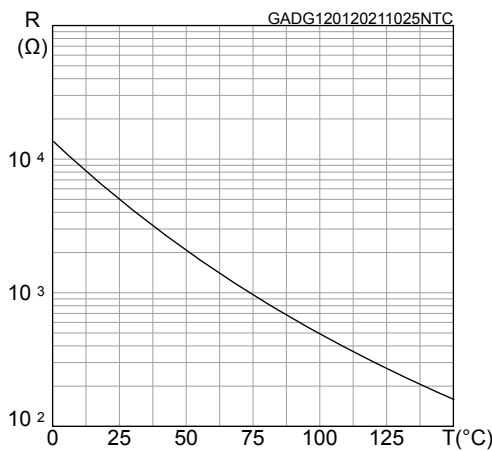

Figure 17. Typical NTC resistance vs temperature



6 Topology, pin description and positioning

Figure 18. Topology, pin description and positioning

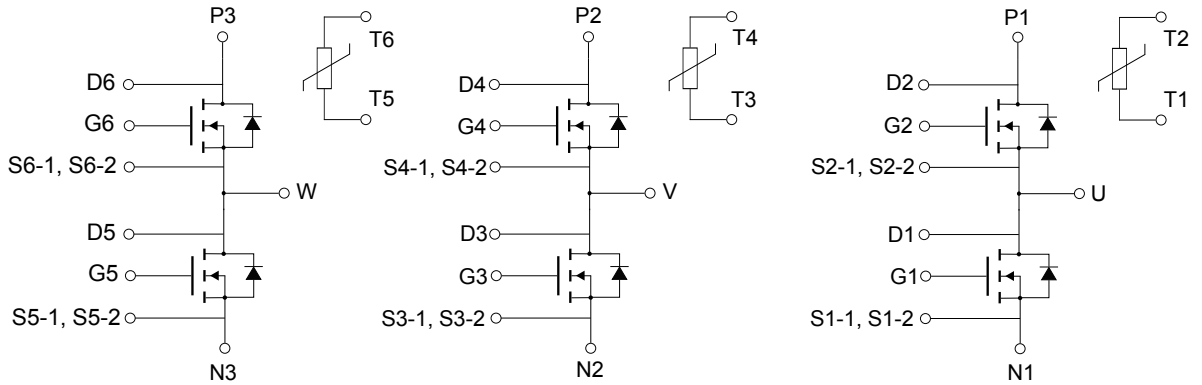
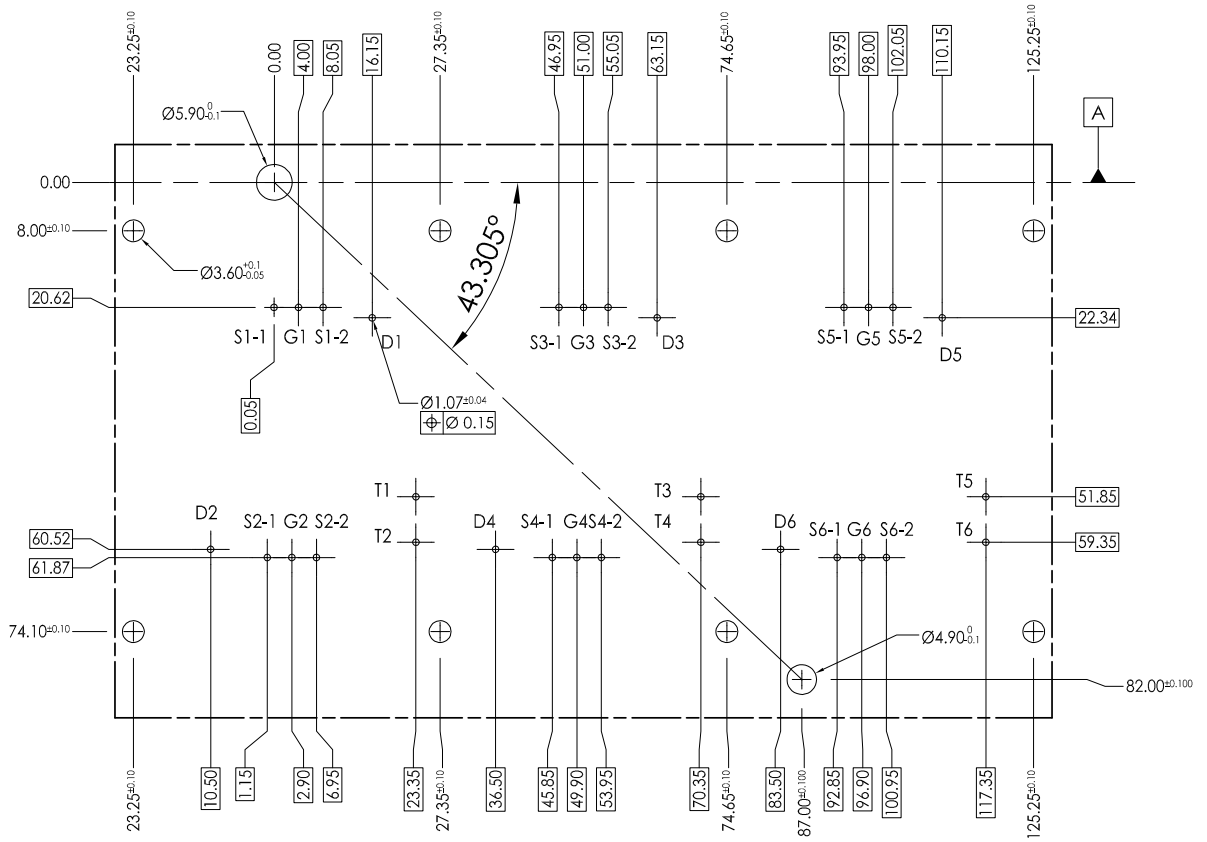

Figure 19. ACEPACK DRIVE PCB drawing (dimensions are in mm.)



PCB thickness 1.60 mm +/-0.16

DM00518615_PCB_Rev5

7 Package information

In order to meet environmental requirements, ST offers these devices in different grades of **ECOPACK** packages, depending on their level of environmental compliance. ECOPACK specifications, grade definitions and product status are available at: www.st.com. ECOPACK is an ST trademark.

7.1 ACEPACK DRIVE package information

Figure 20. ACEPACK DRIVE long tab package outline (dimensions are in mm.)

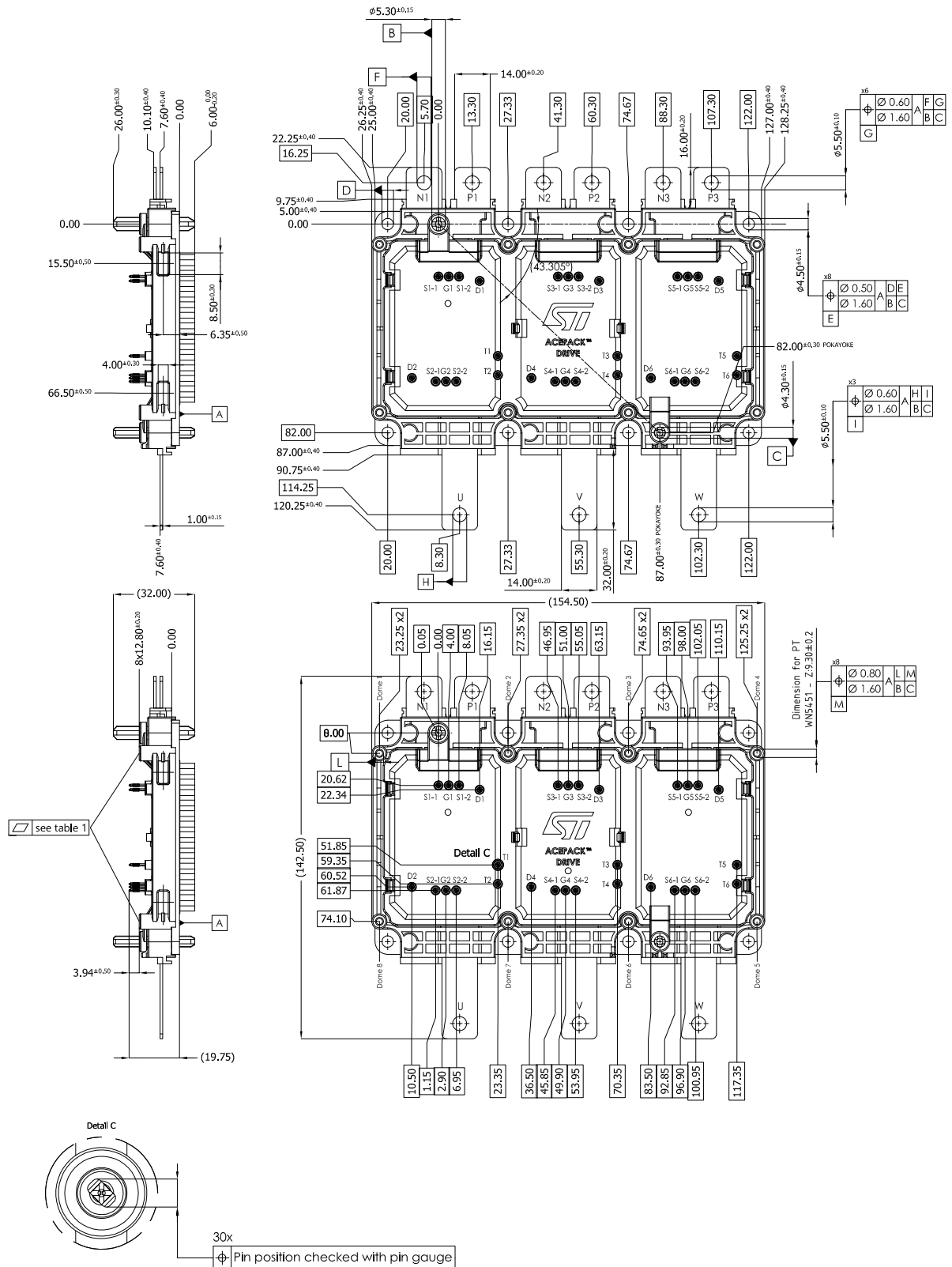

Revision history

Table 8. Document revision history

Date	Version	Changes
03-Jun-2021	1	First release.
10-Aug-2022	2	Modified <i>Section 1 Electrical ratings, Section 2 Electrical characteristics, Table 6. Absolute maximum ratings for NTC temperature sensor, considered as standalone.</i> Added <i>Section 5 Electrical characteristics (curves).</i> Updated <i>Section 7.1 ACEPACK DRIVE package information.</i>
26-Oct-2022	3	Updated Features in cover page. Updated Table 1. Absolute maximum ratings of each switch. Updated Table 2. Thermal data of each switch. Updated Table 3. Electrical characteristics of each switch. Updated Table 5. Source-drain diode characteristics of each switch. Updated Table 7. Ratings for module. Updated Figure 20. ACEPACK DRIVE long tab package outline (dimensions are in mm.).

Contents

1	Electrical ratings	2
2	Electrical characteristics	3
3	NTC	5
4	ACEPACK DRIVE power module details	6
5	Electrical characteristics (curves)	7
6	Topology, pin description and positioning	10
7	Package information	11
	7.1 ACEPACK DRIVE package information	12
	Revision history	13

IMPORTANT NOTICE – READ CAREFULLY

STMicroelectronics NV and its subsidiaries (“ST”) reserve the right to make changes, corrections, enhancements, modifications, and improvements to ST products and/or to this document at any time without notice. Purchasers should obtain the latest relevant information on ST products before placing orders. ST products are sold pursuant to ST’s terms and conditions of sale in place at the time of order acknowledgment.

Purchasers are solely responsible for the choice, selection, and use of ST products and ST assumes no liability for application assistance or the design of purchasers’ products.

No license, express or implied, to any intellectual property right is granted by ST herein.

Resale of ST products with provisions different from the information set forth herein shall void any warranty granted by ST for such product.

ST and the ST logo are trademarks of ST. For additional information about ST trademarks, refer to www.st.com/trademarks. All other product or service names are the property of their respective owners.

Information in this document supersedes and replaces information previously supplied in any prior versions of this document.

© 2022 STMicroelectronics – All rights reserved