



TAOGLAS®



Datasheet

MagmaX

Part No:
AA.212.201111

Description

GNSS L1,L2 and L-Band External Antenna

Features:

Low-profile Housing
Antenna Covering L1,L2 and L-Band
IP67 Waterproof Enclosure
Dims: 63.2mm x 67.2mm x 26.5 mm
Cable: 2m of RG-174
Connector: SMA(M)ST
Custom Cables and Connectors Available
RoHS & Reach Compliant

1.	Introduction	3
2.	Specification	4
3.	Mechanical Drawing	7
4.	Packaging	8
5.	Antenna Characteristics	9
6.	Radiation Patterns	14
7.	LNA Characteristics	21
<hr/>		
	Changelog	26

Taoglas makes no warranties based on the accuracy or completeness of the contents of this document and reserves the right to make changes to specifications and product descriptions at any time without notice. Taoglas reserves all rights to this document and the information contained herein. Reproduction, use or disclosure to third parties without express permission is strictly prohibited.



1. Introduction



Taoglas MagmaX Multiband L1/L2/L-band GNSS Magnetic Mount Antenna

The Taoglas MagmaX AA.212, is a compact, multi-band GNSS, high-performance antenna, for fast fix, high-precision GNSS accuracy. The AA.212 utilizes an advanced 45*45*10mm, wide-band dual-stacked ceramic patch antenna with optimized gain for GPS L1/L2, Galileo, GLONASS, BeiDou, and L-Band bands.

Typical Applications Include:

- Precision Agriculture
- Navigation
- Robotics and Autonomous Vehicles
- Transportation and Telematics

The MagmaX exhibits excellent radiation patterns and has been optimized to cover the bands required for the next generation of L1/L2 GNSS receivers that are currently on the market. The AA.212 has been designed as a premium solution for high-precision GNSS systems by including L-Band coverage, for when GNSS correction services are utilized. L-Band correction services use GNSS systems to decode satellite transmissions and will output a correction stream, enabling a high-precision system to reach genuine cm-level accuracy.

The robust ABS enclosure is IP67-rated, allowing the product to be used with confidence in harsh environments where precise positioning is required. The AA.212 comes with 2m of RG-174 cable and SMA(M) connector as standard but as with all Taoglas products, cable and connectors are fully customizable depending on your requirements. For further information please contact your regional Taoglas customer support team to request these services or additional support to integrate and test this antenna's performance with your device.

2. Specification

GNSS Frequency Bands					
GPS	L1 1575.42 MHz	L2 1227.6 MHz	L5 1176.45 MHz		
	■	■	□		
GLONASS	G1 1602 MHz	G2 1248 MHz	G3 1207 MHz		
	■	■	□		
Galileo	E1 1575.24 MHz	E5a 1176.45 MHz	E5b 1201.5 MHz	E6 1278.75 MHz	
	■	□	□	□	
BeiDou	B1C 1575.42 MHz	B1I 1561 MHz	B2a 1176.45 MHz	B2b 1207.14 MHz	B3 1268.52 MHz
	■	■	□	□	□
L-Band	L-Band 1542 MHz				
	■				
QZSS (Regional)	L1 1575.42 MHz	L2C 1227.6 MHz	L5 1176.45 MHz	L6 1278.75e6	
	■	■	□	□	
IRNSS (Regional)	L5 1176.45 MHz				
	□				
SBAS	L1/E1/B1 1575.42 MHz	L5/B2a/E5a 1176.45 MHz	G1 1602 MHz	G2 1248 MHz	G3 1207 MHz
	■	□	■	□	□

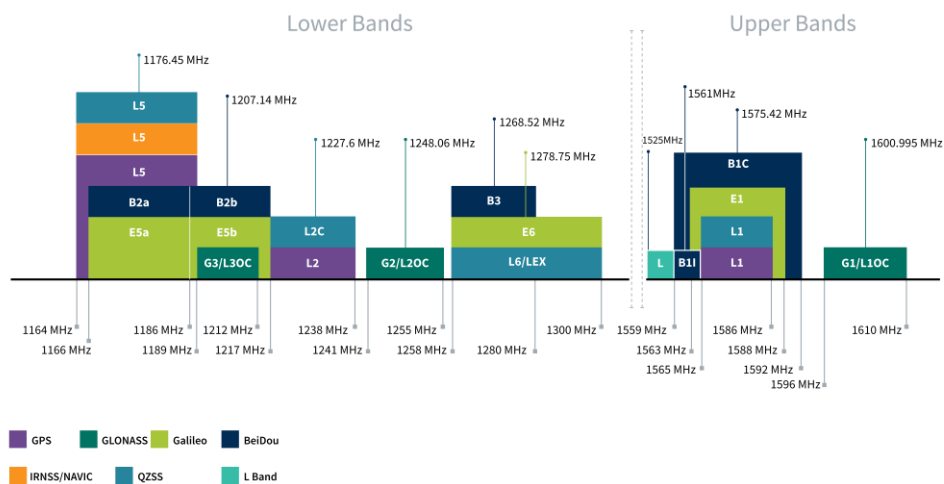

GNSS Bands and Constellations

GNSS Electrical

Frequency (MHz)	GPS L2	GLONASS G2	L-Band	BeiDou B1	GPS L1C	GLONASS L1
	1215-1239 MHz	1237-1254 MHz	1525-1559	1559-1563 MHz	1564-1587MHz	1593-1610MHz
VSWR (max.)	1:1	1:1	1:1	1:1	1:1	1:1
Passive Antenna Efficiency (%)	43.95	36.40	49.02	75.16	75.56	77.21
Passive Antenna Average Gain (dB)	-3.59	-4.42	-3.10	-1.24	-1.22	-1.12
Passive Antenna Peak Gain (dBi)	0.36	-0.31	3.01	4.95	5.00	5.12
Axial Ratio (dB)	6.43	4.08	0.5	0.7	0.84	0.95
PCO x (cm)	2.24	2.3	2.85	2.81	2.69	2.44
PCO y (cm)	4.8	4.84	7.22	7.33	7.21	6.83
PCV (cm)	0.009	0.01	0.016	0.0133	0.011	0.007
Polarization	RHCP					
Impedance	50 Ω					
Cable	RG174					
Connector	SMA(M)					

LNA and Filter Electrical Properties

Frequency (MHz)	GPS L2	GLONASS G2	L-Band	BeiDou B1	GPS L1C	GLONASS L1
	1215-1239 MHz	1237-1254 MHz	1525-1559	1559-1563 MHz	1564-1587MHz	1593-1610MHz
Gain (dB)	29.8	28.3	28.6	28.6	28.6	26.5
Noise Figure (dB)	2.3	2.6	2.4	2.0	1.9	2.4
Group Delay (ns)	13.5	25.3	13.9	8.5	13.3	8.7
Out Of Band Rejection (dB)	> 70dB @ LTE low band; > 60dB @ LTE high band					
Current Consumption(mA)	15					

Mechanical	
Dimensions	63.2mm x 67.2mm x 26.5mm
Weight	—
Material	ABS
Connector	SMA(M) ST
Cable	2m RG174 Coaxial

Environmental	
Temperature Range	-40°C to 85°C
Relative Humidity	20% to 65%
RoHs & REACH Compliant	Yes

3. Mechanical Drawing

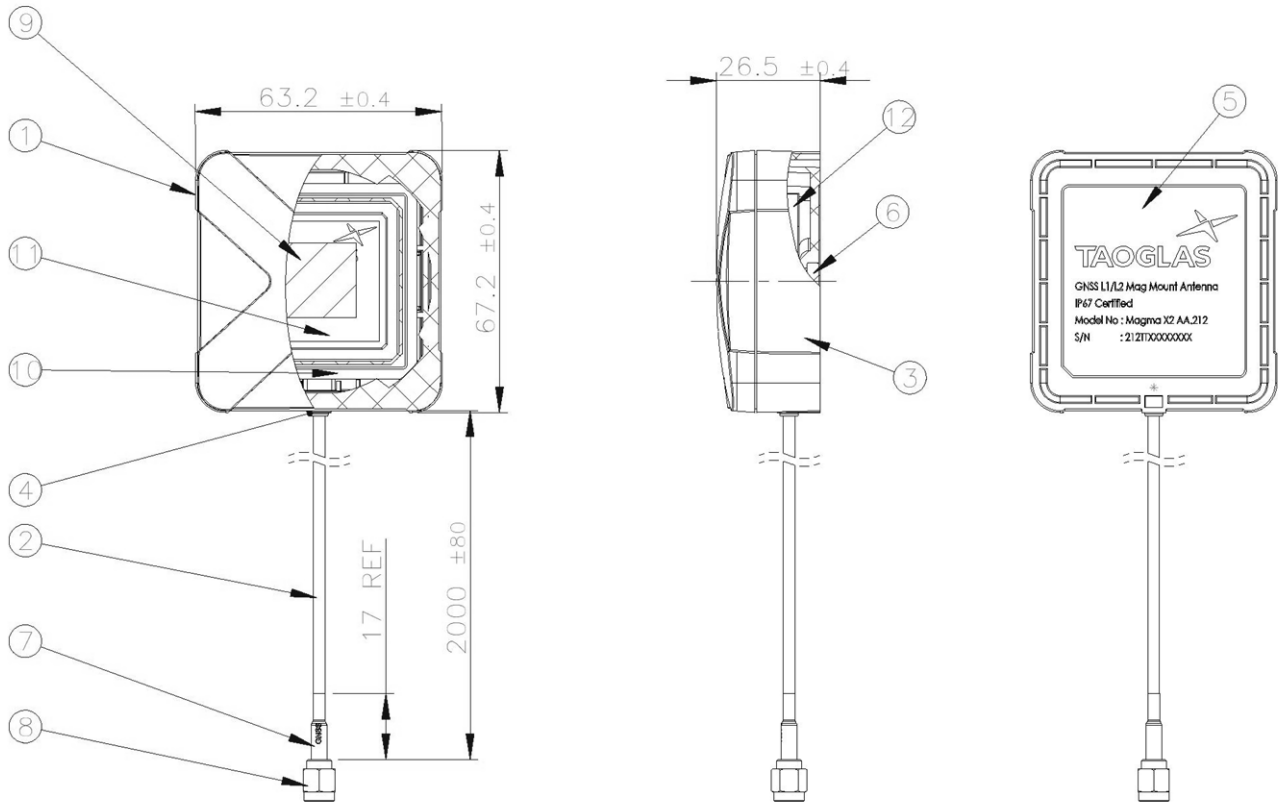

	Name	Material	Finish	Qty
1	Top Housing	ABS	Black	1
2	RG174 Coaxial Cable	PVC	Black	1
3	Bottom Housing	ABS	Black	1
4	Silicon Rubber	Silicone	Black	1
5	AA.212 Label	PET	Matte Silver	1
6	Ø18*3t N48M NdFeB Ni Plated	N48M NdFeB	Ni Plated	1
7	Heat Shrink Tube (GNSS)	PE	Blue Tube/White Text	1
8	SMA(M)ST	Brass	Au Plated	1
9	3M Double Adhesive + Foam (4T) (19X19)	3M 9448HK + CR4305 4t + 3M 9448HK	White liner	1
10	PCB_AA.212_Dual Layer	Composite 1t	Black	1
11	GNSS L1,L2 L-Band Dual Feed Stacked 45*45*10mm Patch	Ceramic	Clear	1
12	Shielding Case	STPE	N/A	1

4. Packaging

1pcs AA.212 per Small PE Bag
Weight - 165g



10pcs AA.212 per Large PE Bag
Weight - 1650g

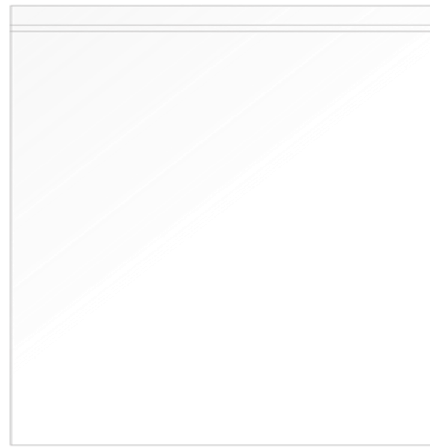

100pcs AA.212 per carton
Dimensions - 370*370*300mm
Weight - 17Kg

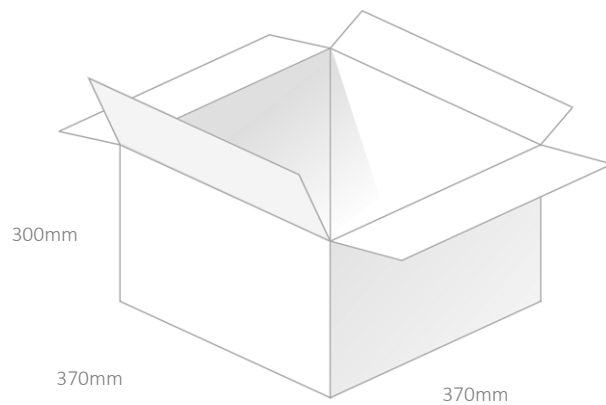

5. Antenna Characteristics

5.1 Test Setup

AUT



Vector Network Analyzer

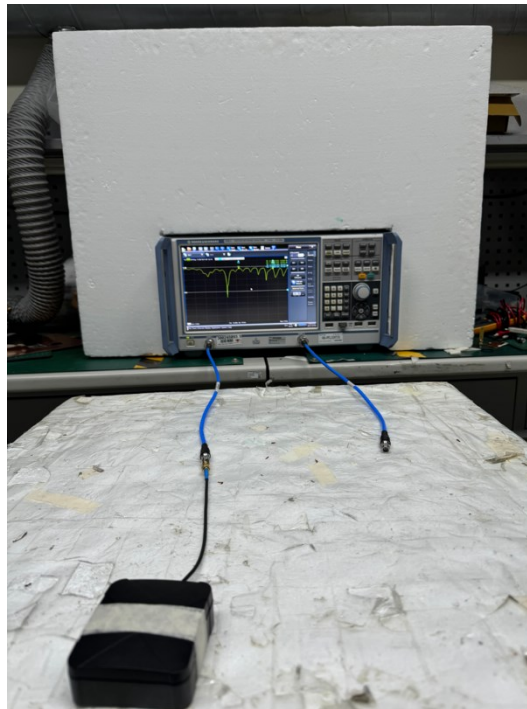

VNA Test Set-up

5.2 Return Loss

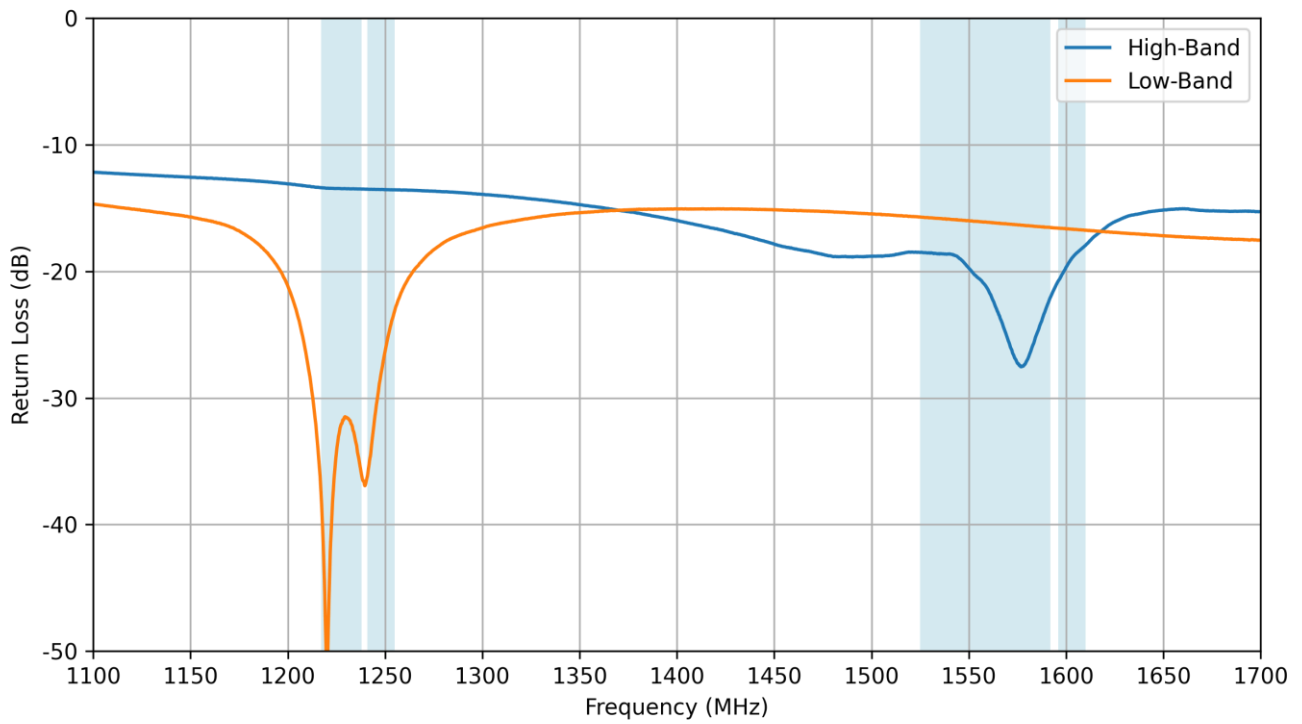

5.3 VSWR

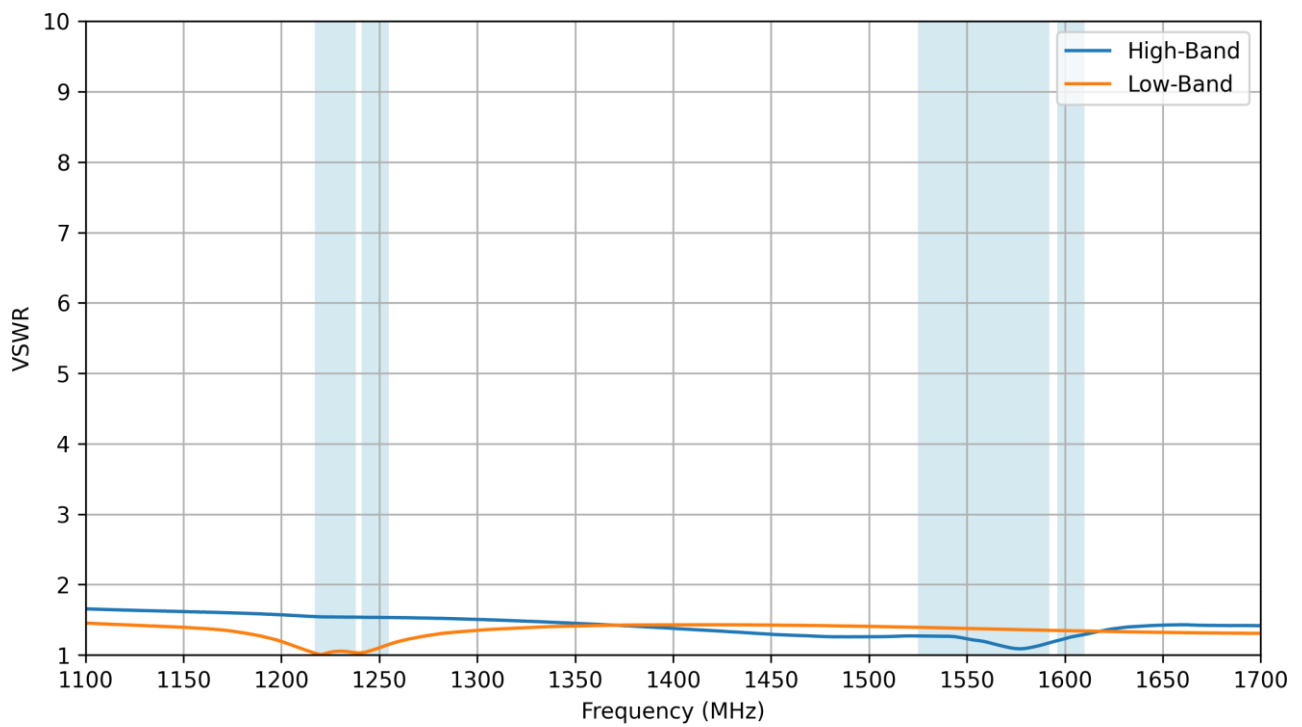

5.4 Efficiency

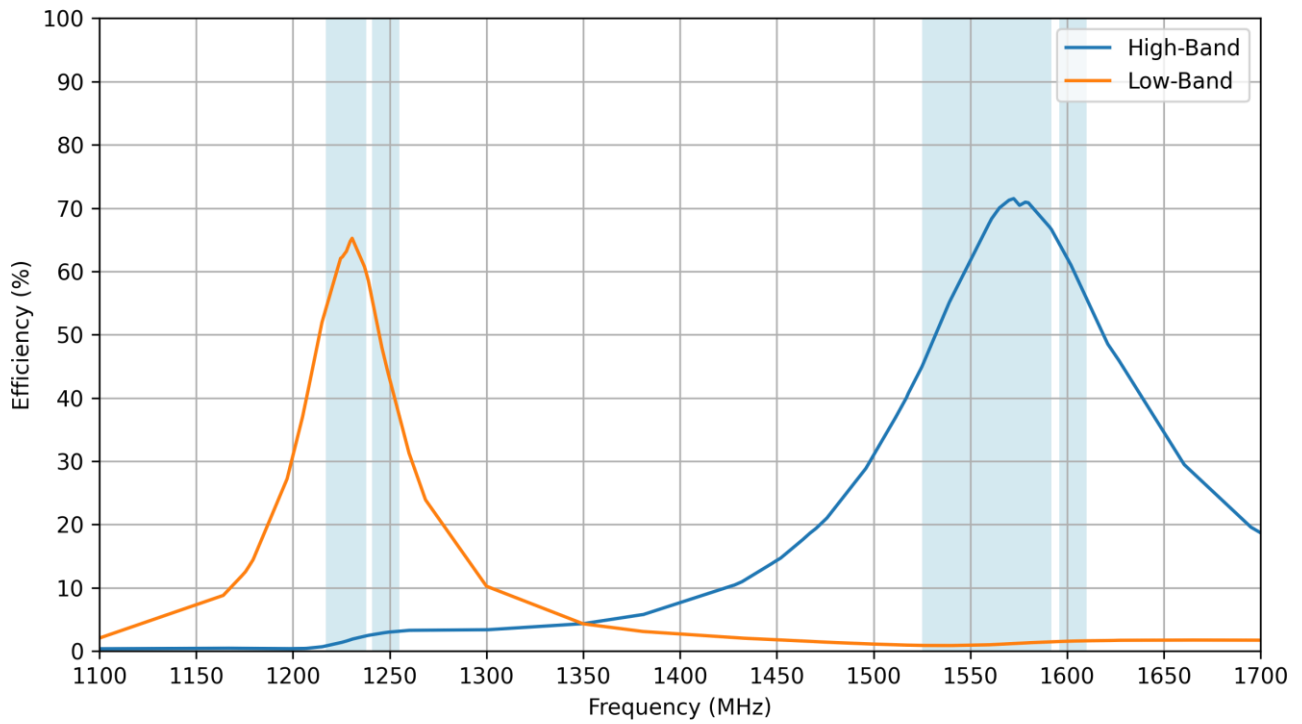

5.5 Average Gain

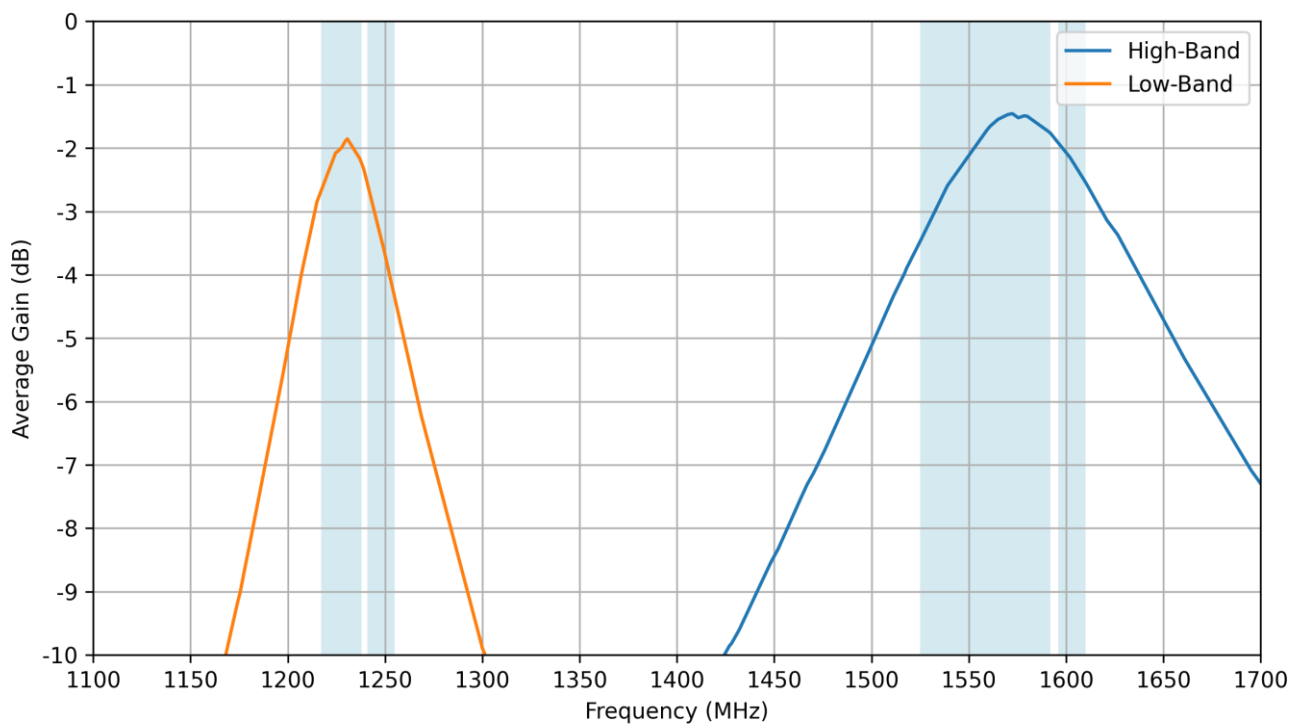

5.6 Peak Gain

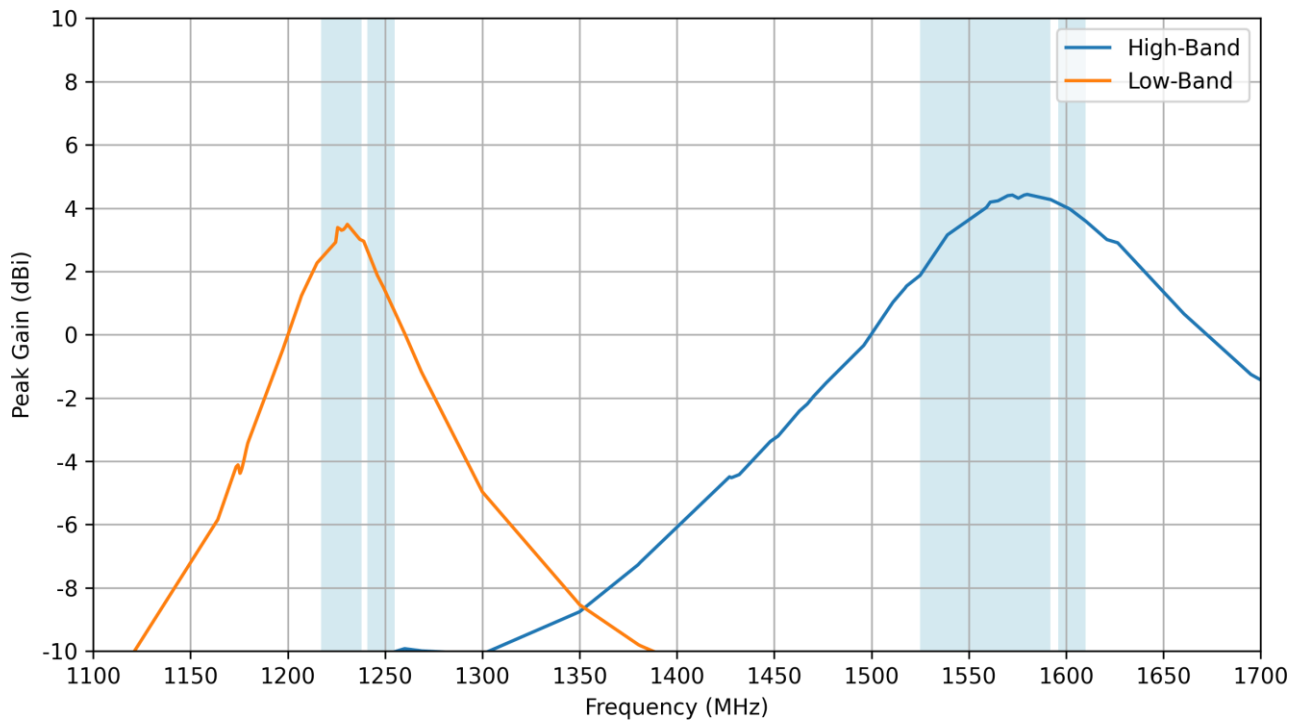

5.7 PCO

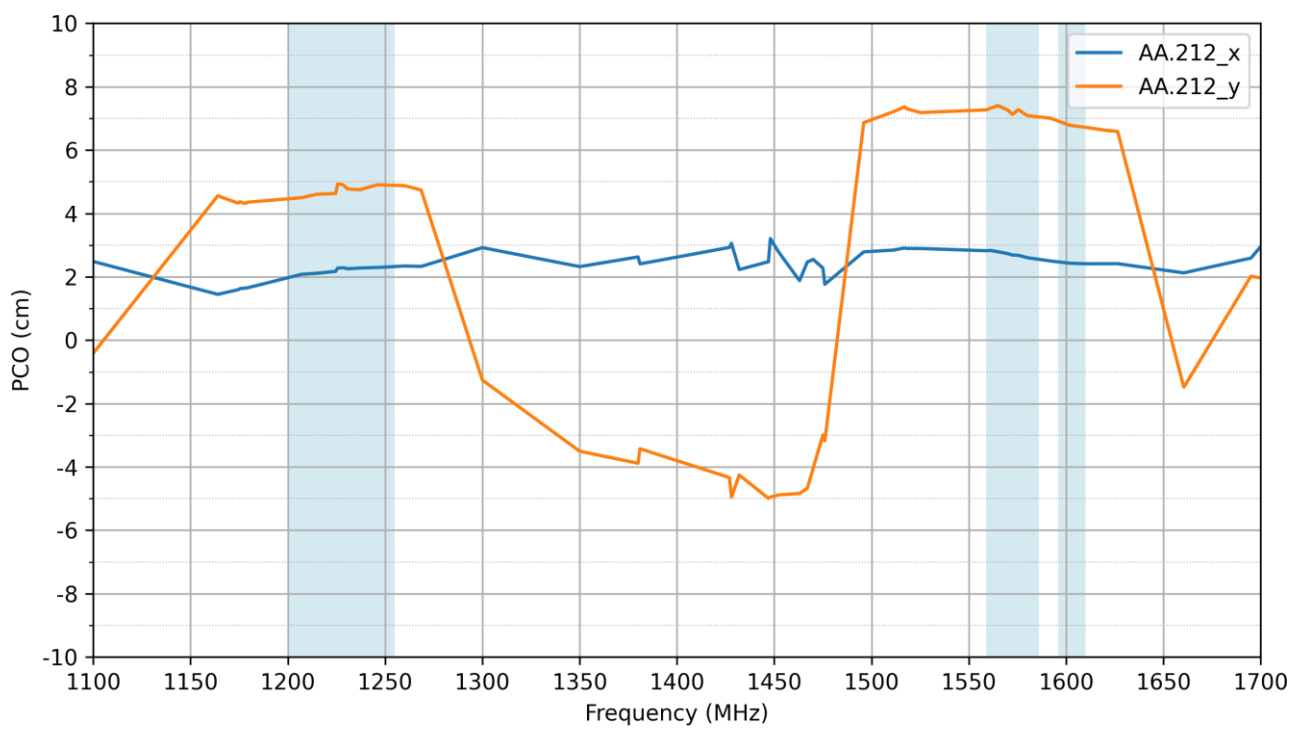

5.8 PCV

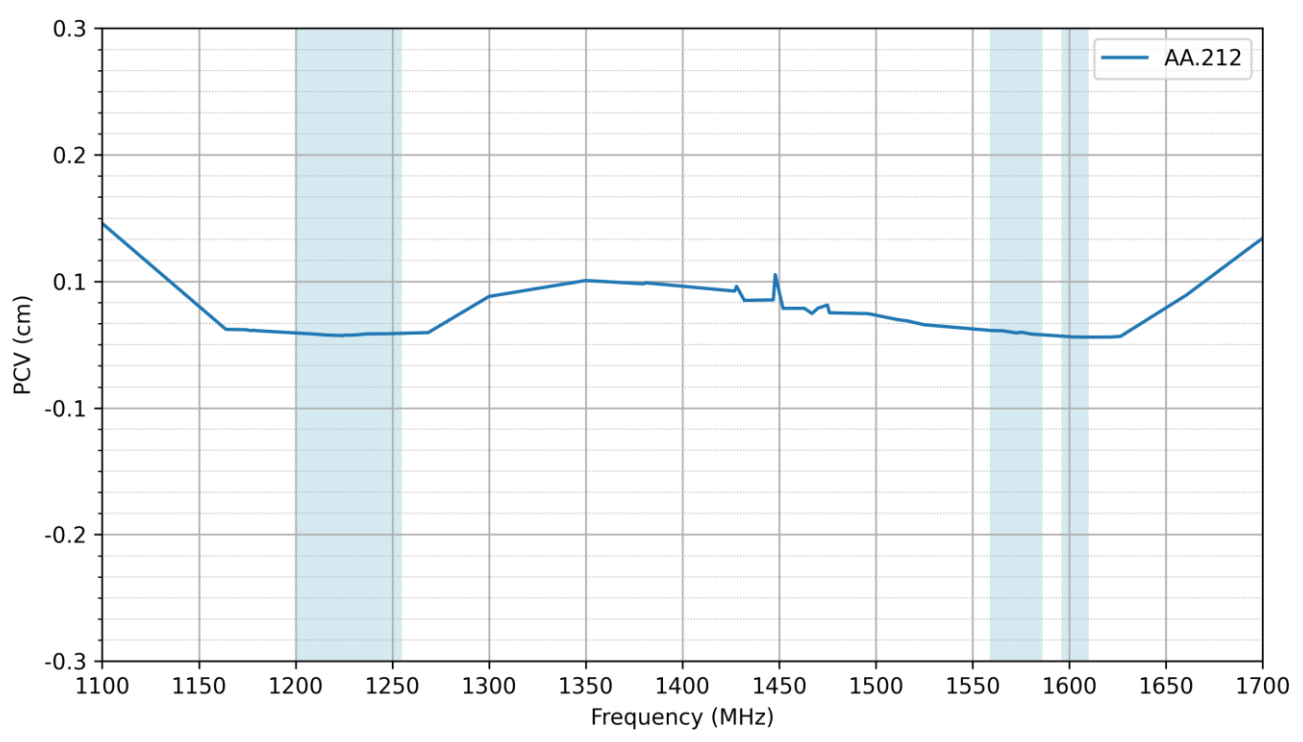

5.9 Axial Ratio

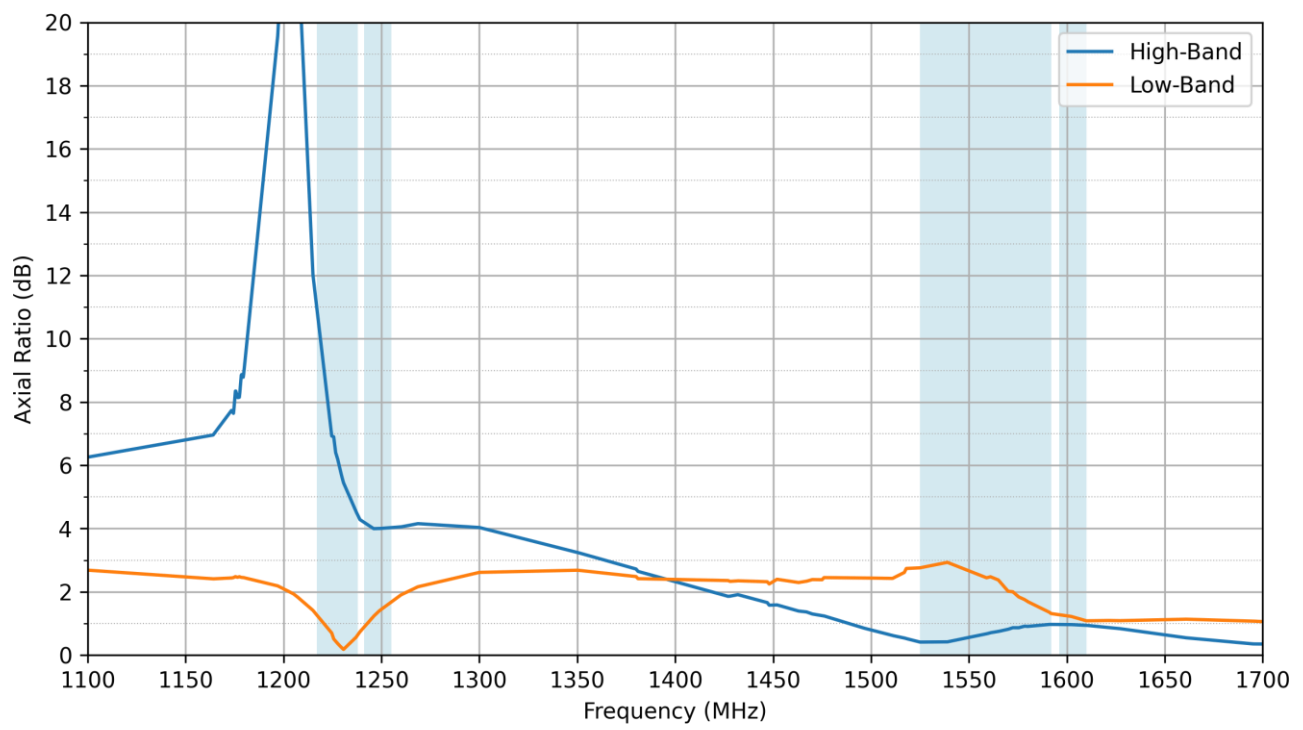

6. Radiation Patterns

6.1 Test Setup

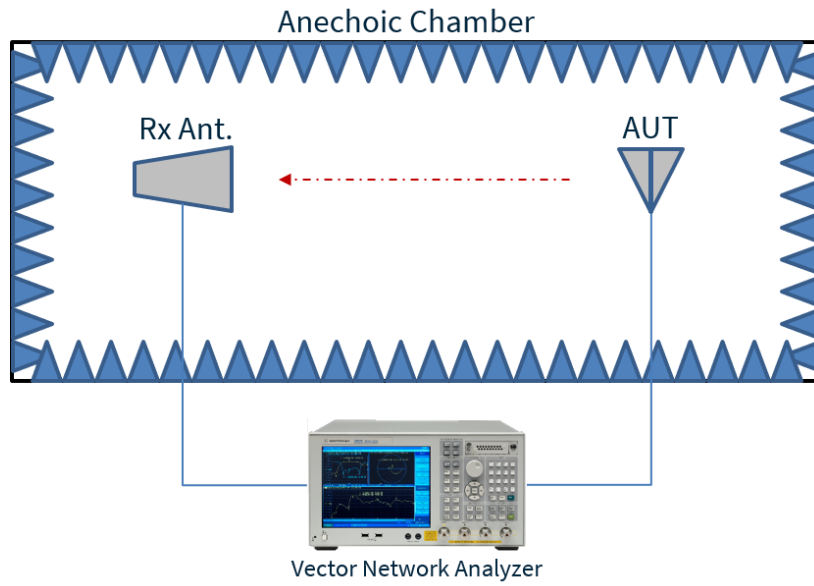

Chamber Test Set-up

6.2 Patterns at 1228 MHz

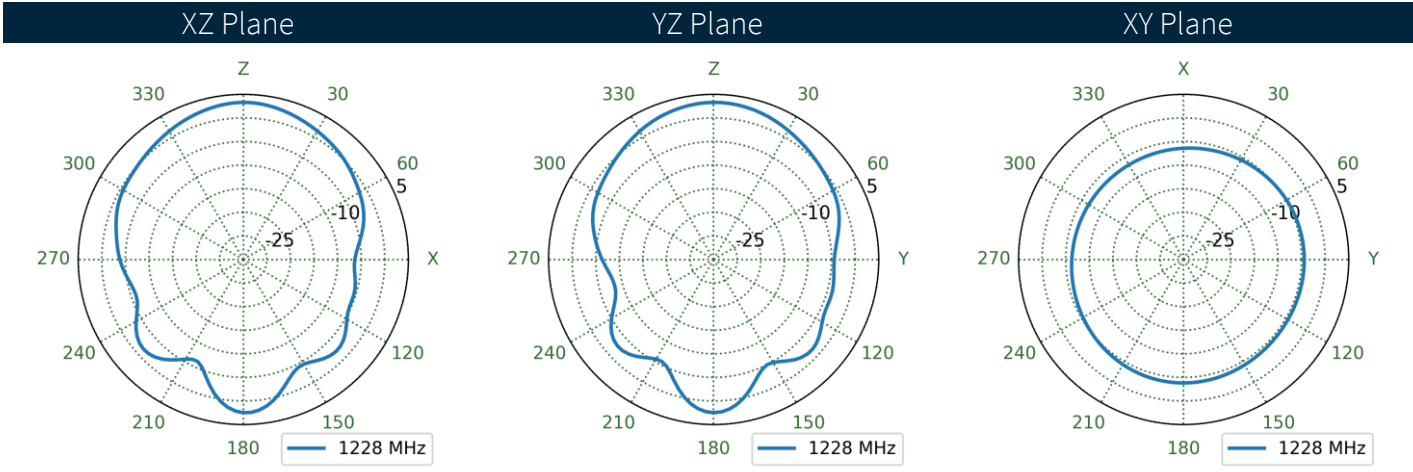
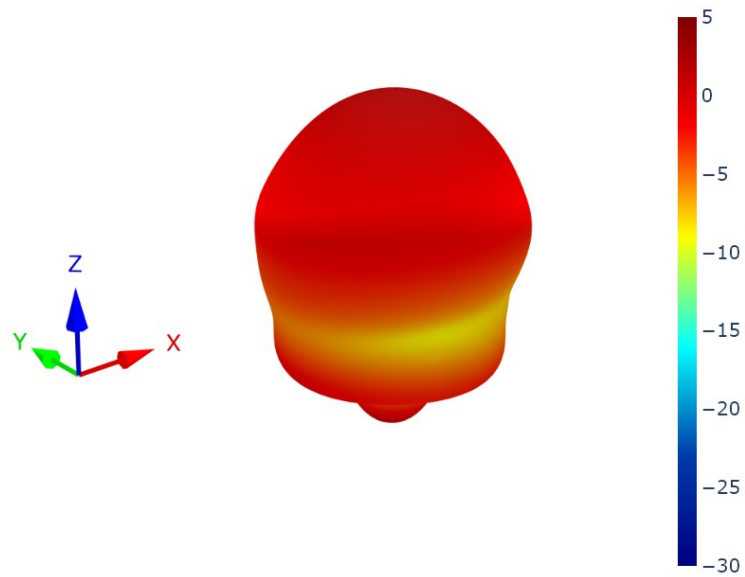

6.3 Patterns at 1249 MHz

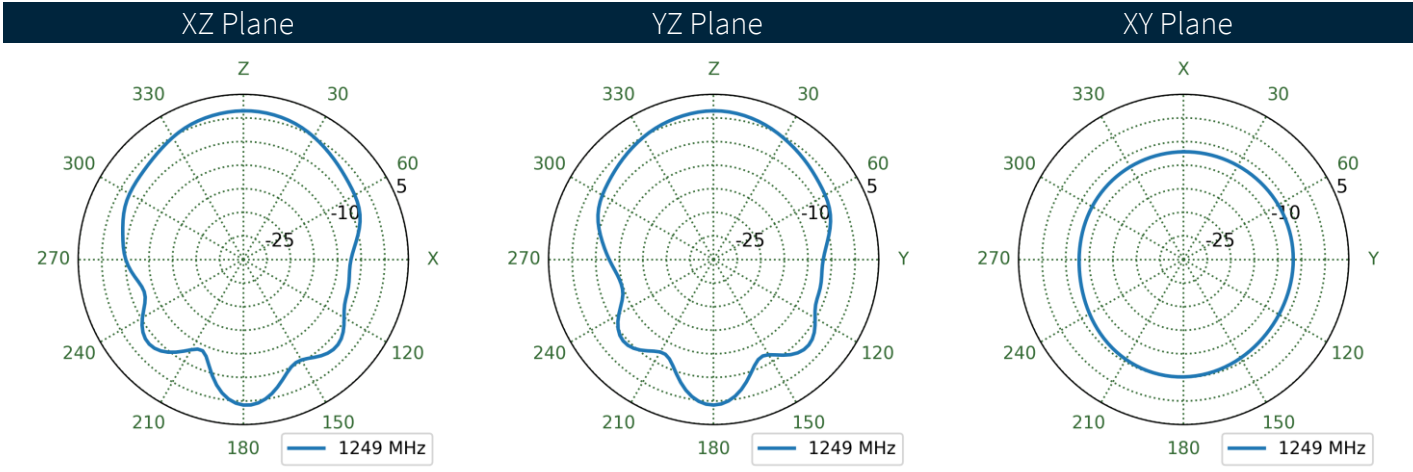
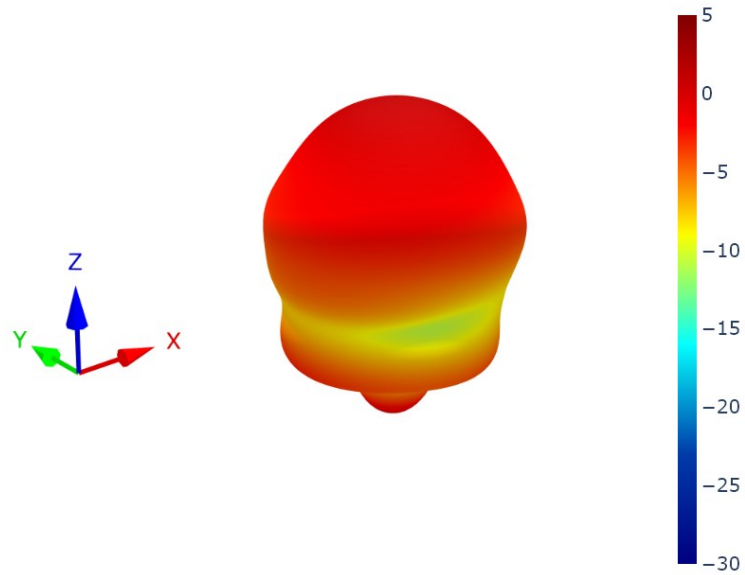

6.4 Patterns at 1539 MHz

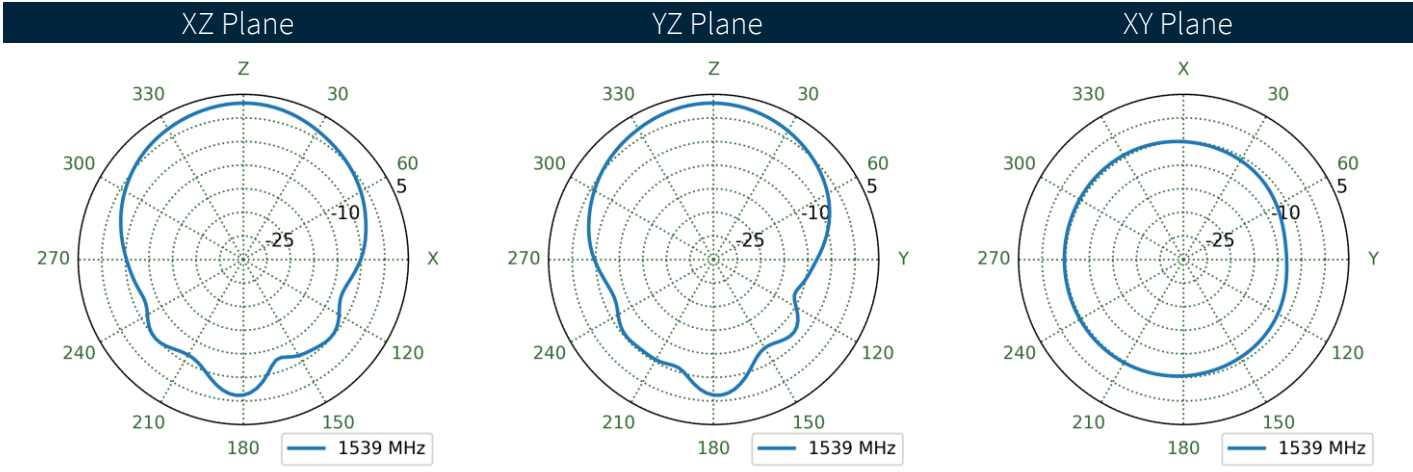
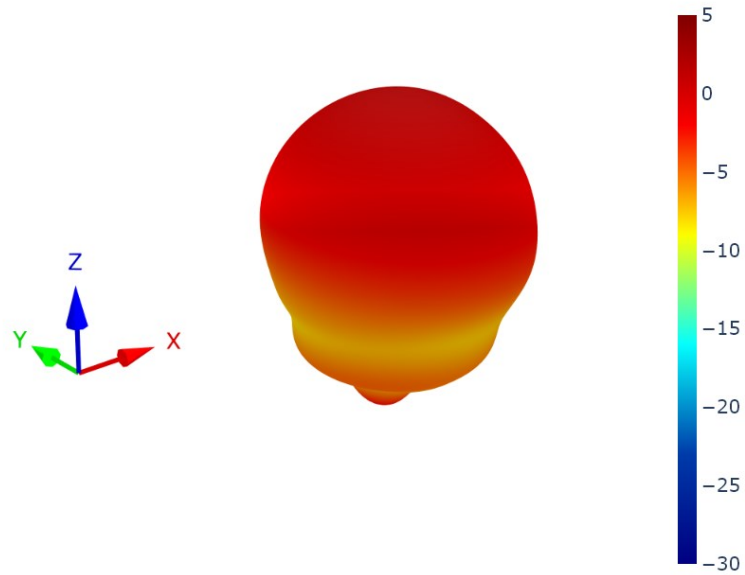

6.5 Patterns at 1561 MHz

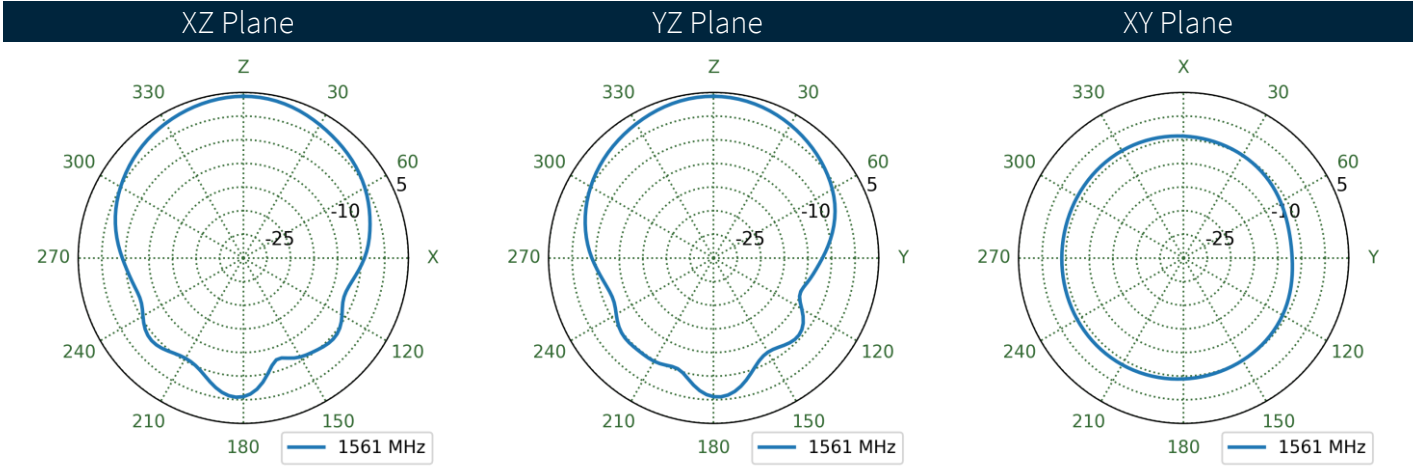
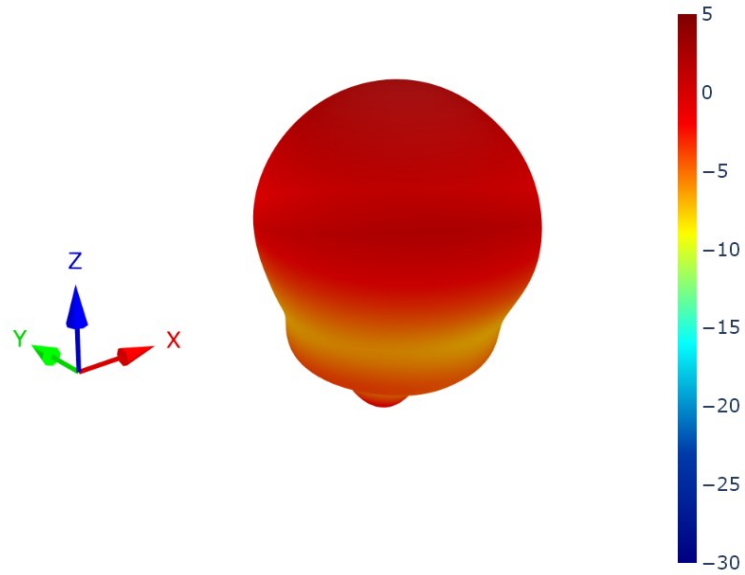

6.6 Patterns at 1575 MHz

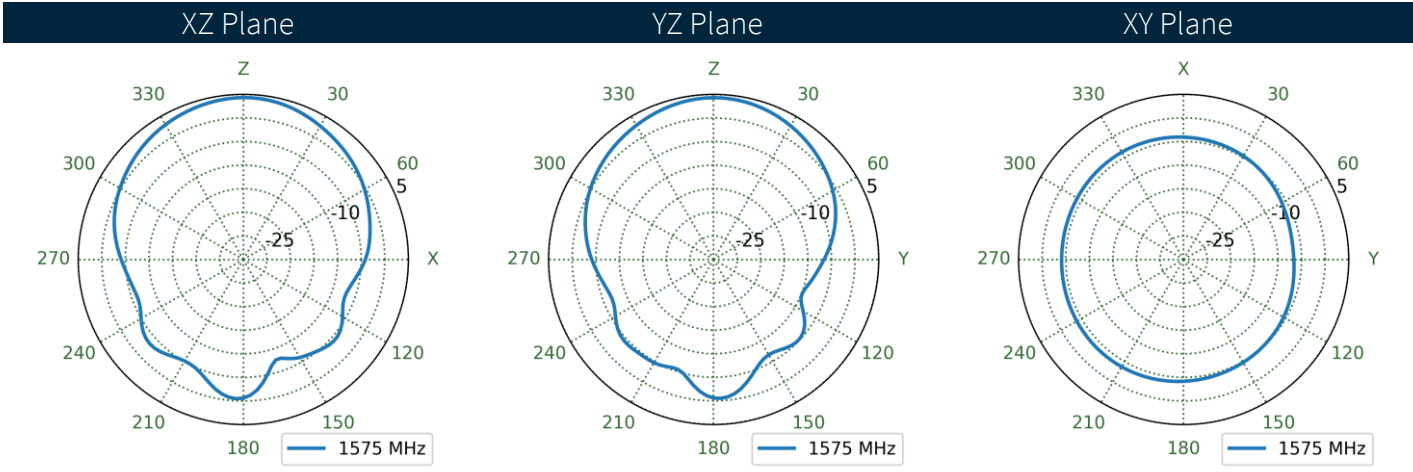
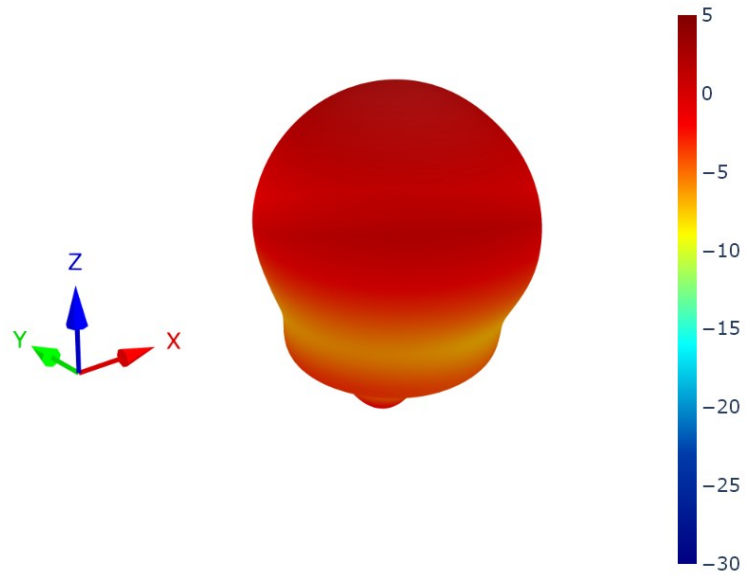

6.7 Patterns at 1602 MHz

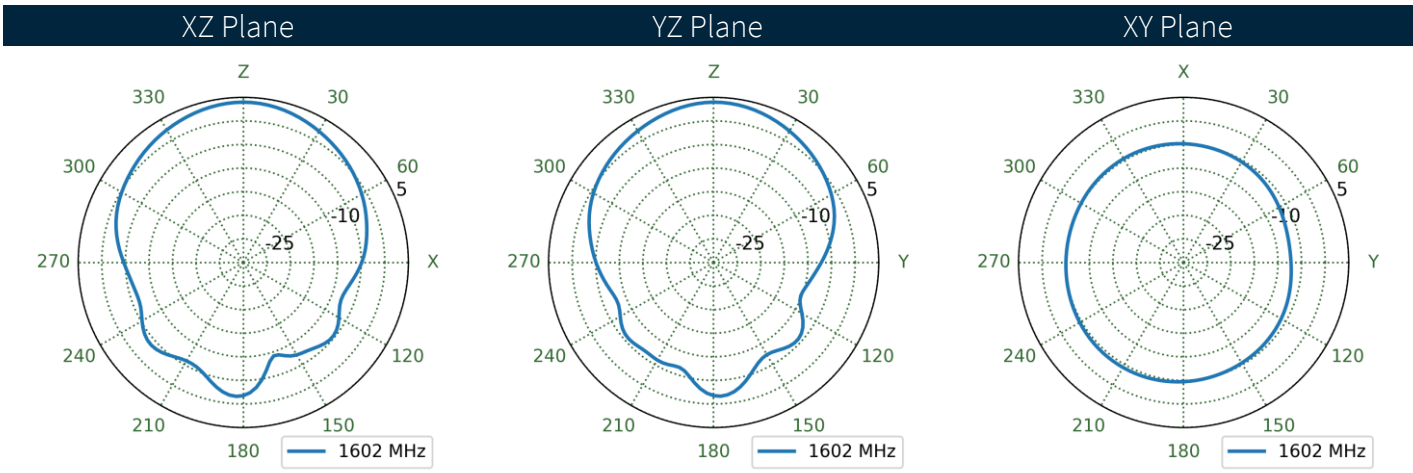
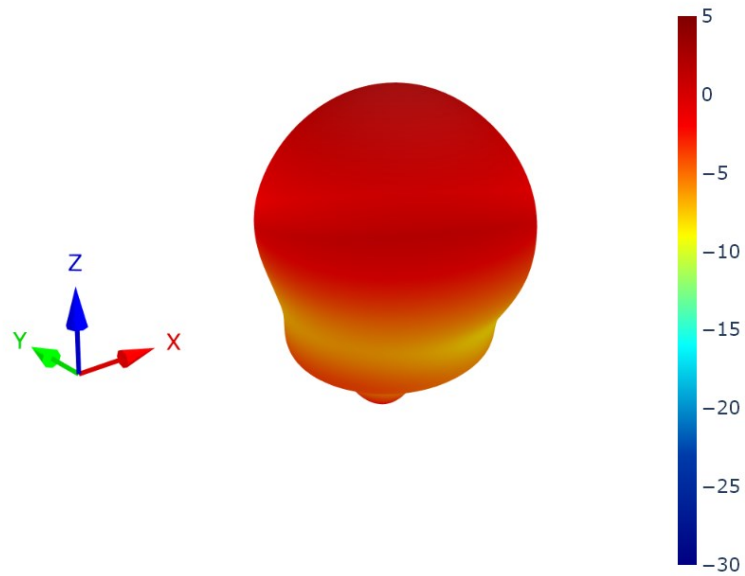

7. LNA Characteristics

7.1 Block Diagram

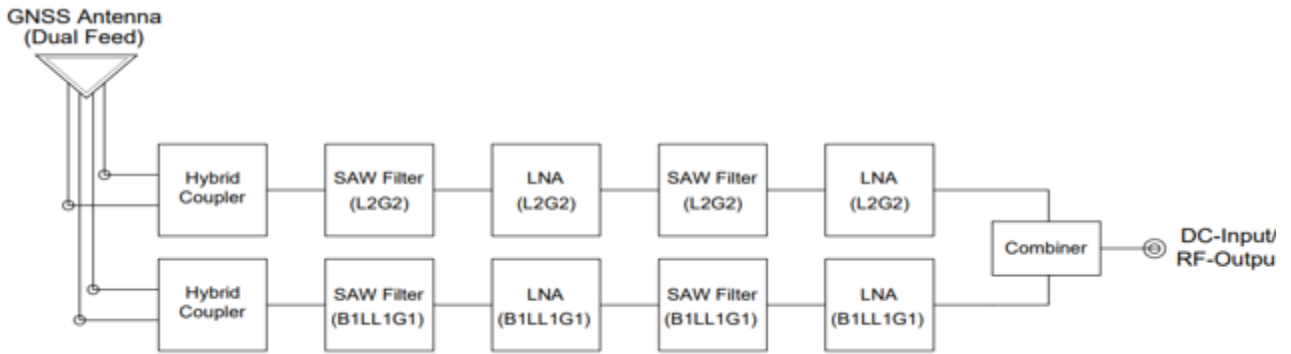

7.2 Gain Low-Band

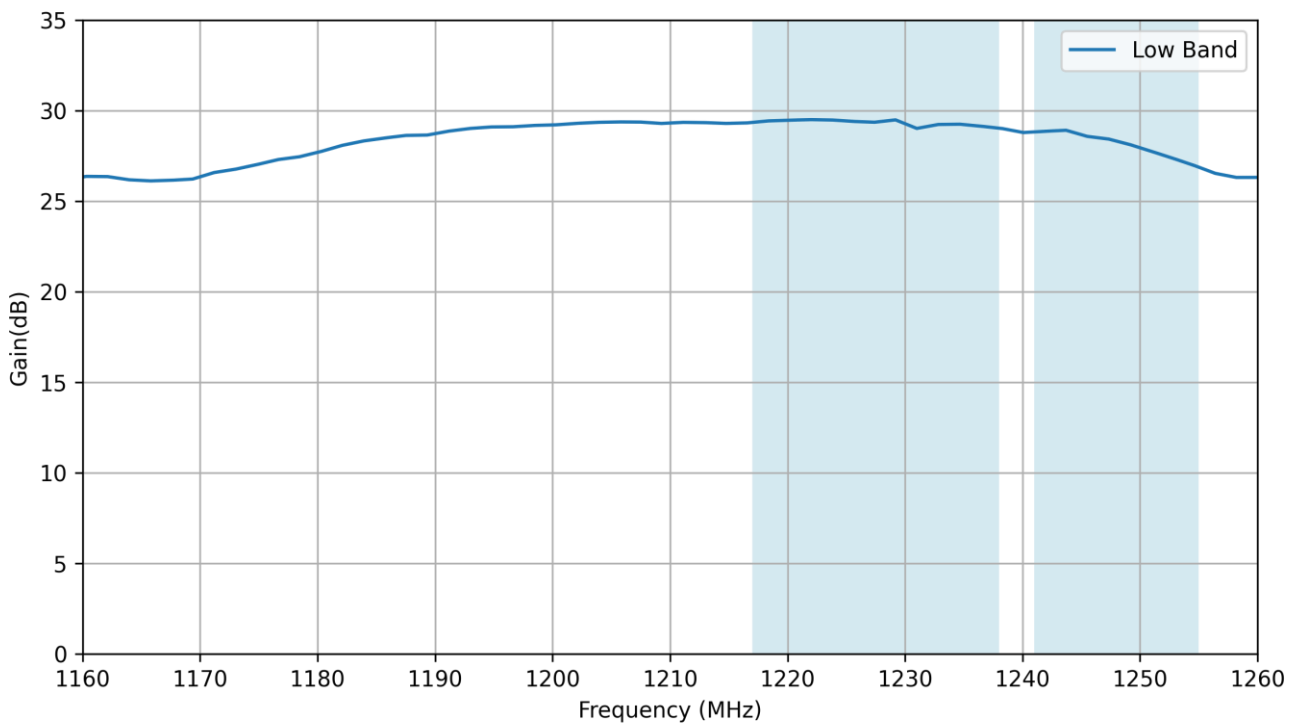

7.3 Gain High-Band

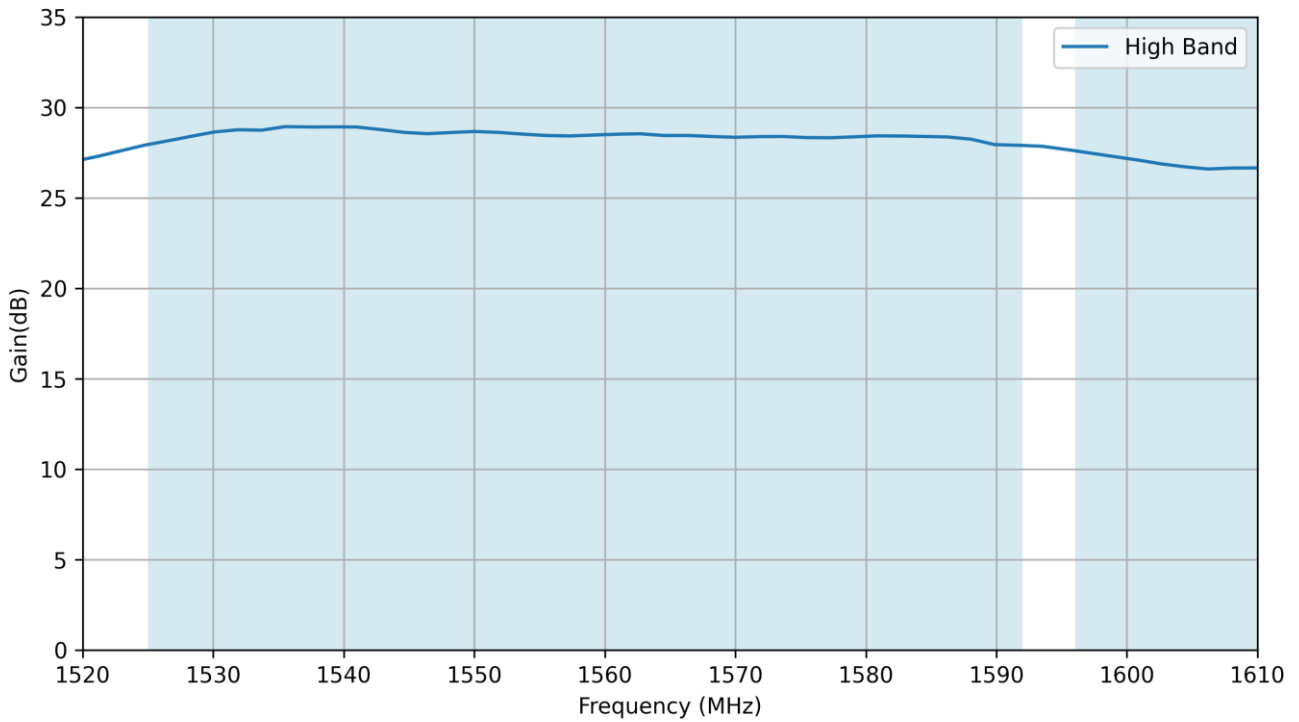

7.4 Noise Figure Low-Band

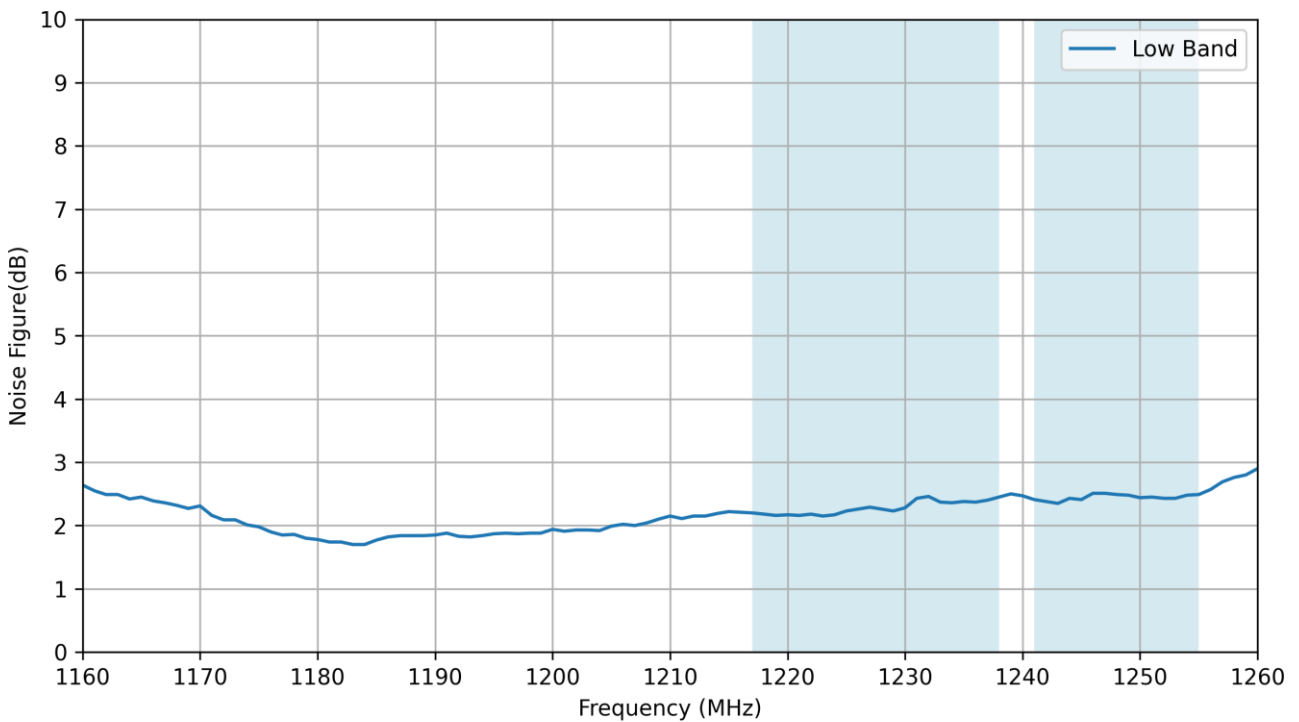

7.5 Noise Figure High-Band

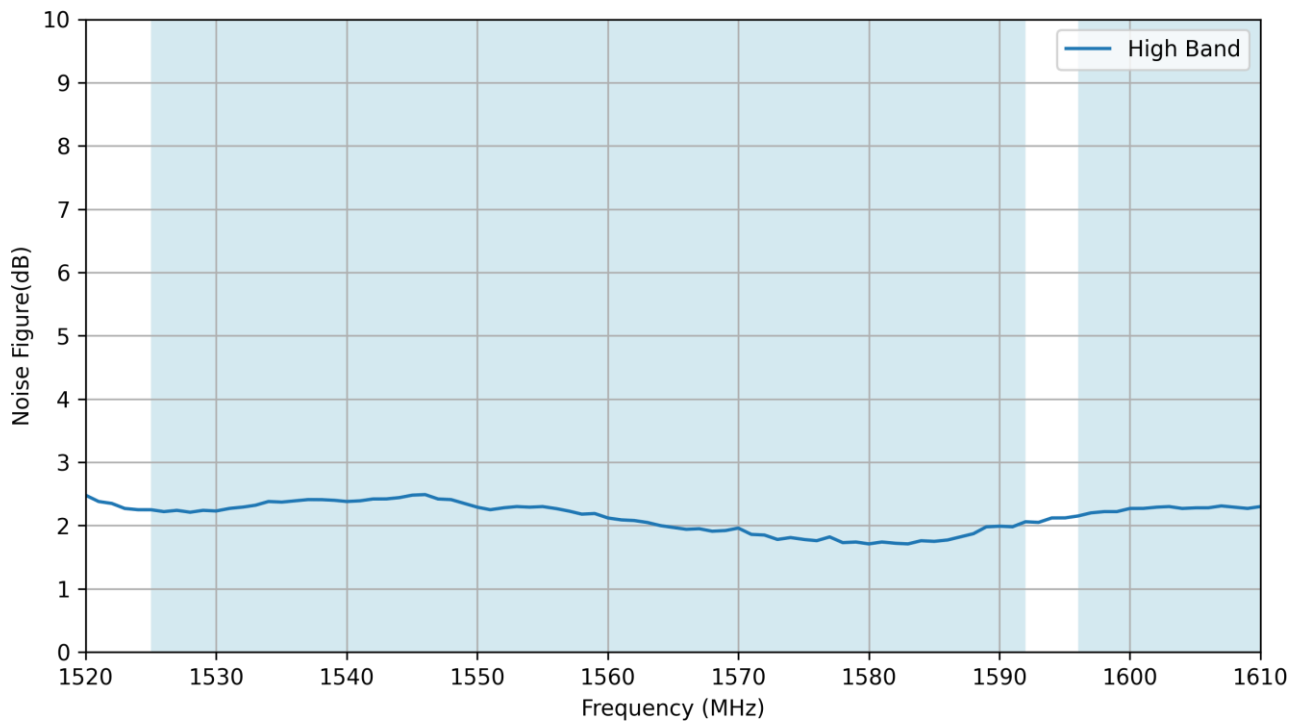

7.6 Out Of Band Rejection

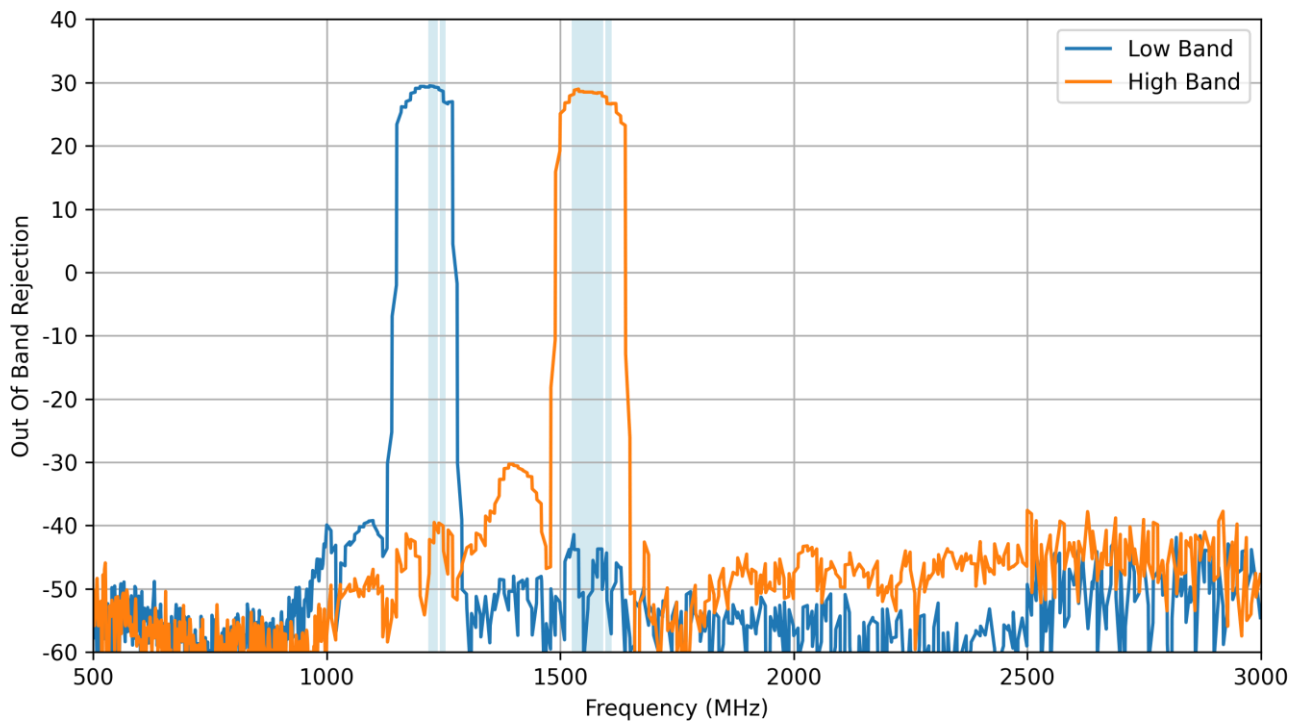

Changelog for the datasheet

SPE-24-8-127 – AA.212.201111

Revision: A (Original First Release)

Date: 2024-06-13

Notes: Initial Release

Author: Gary West

Previous Revisions



www.taoglas.com

