



# TAOGLAS®



# Datasheet

**Part No:**  
TU.63.2111

**Description**

Terminal Mount 6-8.5GHz 2.5dBi Ultra-Wideband Antenna with SMA(M)

**Features:**

Compact, Low-profile Screw Mount UWB Antenna  
Covering Worldwide UWB Bands from 6GHz – 8.5GHz  
IP67 Waterproof Rated  
Dimensions:  $\varnothing$ 8.2 x 35.8mm  
Connector: SMA(M)  
RoHS & Reach Compliant

<b>1.</b>	<b>Introduction</b>	<b>3</b>
<b>2.</b>	<b>Enclosure isSpecification</b>	<b>4</b>
<b>3.</b>	<b>Mechanical Drawing</b>	<b>5</b>
<b>4.</b>	<b>Packaging</b>	<b>6</b>
<b>4.</b>	<b>Antenna Characteristics</b>	<b>7</b>
<b>5.</b>	<b>Radiation Patterns</b>	<b>11</b>
<hr/>		
	Changelog	30

Taoglas makes no warranties based on the accuracy or completeness of the contents of this document and reserves the right to make changes to specifications and product descriptions at any time without notice. Taoglas reserves all rights to this document and the information contained herein. Reproduction, use or disclosure to third parties without express permission is strictly prohibited.



# 1. Introduction



## Super Small, UWB Antenna for High-performance Indoor Positioning, Asset and Access Applications

The Taoglas TU.63 is a unique, super compact, terminal mount ultra-wideband (UWB) antenna. It is engineered to cover all worldwide UWB frequencies between 6 and 8.5 GHz. With excellent efficiency and an omnidirectional radiation pattern with up to 6 dBi gain, it provides strong, homogeneous coverage in all directions from the UWB sensor. The TU.63 is ground plane independent and exhibits exceptional efficiencies of up to 91% on specific bands. The product is mounted with a standard SMA(M) connector, and the enclosure is manufactured from robust ABS material making it suitable for use in harsh environments.

The potential of UWB is enabling a wave of applications that use highly accurate, ultra-reliable location, and distance sensing to deliver new experiences and capabilities. It operates with low power for transmitting large amounts of digital data over a wide spectrum of frequency bands typically spanning more than 500MHz with very low power for short distances up to 250m with latency speeds as low as 1ms. The low power requirements of UWB results in the increased battery life of sensors and tags which in turn reduces overall operational costs.

Typical Applications Include:

- Indoor position location and asset tracking applications
- Smart home device control and entertainment systems
- Keyless entry and access control systems

The TU.63 is a powerful antenna and one of several Taoglas-developed antennas designed for seamless integration and compatibility with any UWB sensor module on the market. Contact your regional Taoglas customer support team for further information.

## 2. Enclosure isSpecification

LTE Electrical									
Band	Frequency (MHz)	Measurement	Efficiency (%)	Average Gain (dB)	Peak Gain (dBi)	Impedance	Polarization	Radiation Pattern	Power Consumption
LRP CH0	6200-6800	Eval Board 150x90mm	78.9	-1.03	5.84	50 Ω	Linear	Omni	2-5W
		Eval Board 90x150mm	75.1	-1.25	6.07				
		Free Space	79.7	-0.99	3.44				
LRP CH 4	6400-7000	Eval Board 150x90mm	75.8	-1.20	5.76				
		Eval Board 90x150mm	72.0	-1.42	5.95				
		Free Space	76.1	-1.18	3.53				
HRP CH6/LRP CH 1	6700-7300	Eval Board 150x90mm	67.3	-1.72	5.07				
		Eval Board 90x150mm	63.9	-1.95	4.81				
		Free Space	67.4	-1.72	3.53				
LRP CH 5	7000-7600	Eval Board 150x90mm	64.7	-1.89	5.49				
		Eval Board 90x150mm	61.6	-2.10	4.31				
		Free Space	66.5	-1.77	3.38				
HRP CH 8	7200-7800	Eval Board 150x90mm	65.8	-1.82	5.49				
		Eval Board 90x150mm	62.0	-2.08	4.31				
		Free Space	69.1	-1.61	4.02				
HRP CH 9/LRP CH 6	7700-8300	Eval Board 150x90mm	58.2	-2.35	5.30				
		Eval Board 90x150mm	53.7	-2.70	4.18				
		Free Space	72.7	-1.38	4.45				

Mechanical	
Dimensions	Ø8.2 x 35.8mm
Weight	6g
Material	Silicon
Connector	SMA(M)

Environmental	
Temperature Range	-40°C to 85°C
Humidity	Non-condensing 65°C 95% RH
IP Rating	IP67
RoHS Compliant	Yes
REACH Compliant	Yes



### 3. Mechanical Drawing

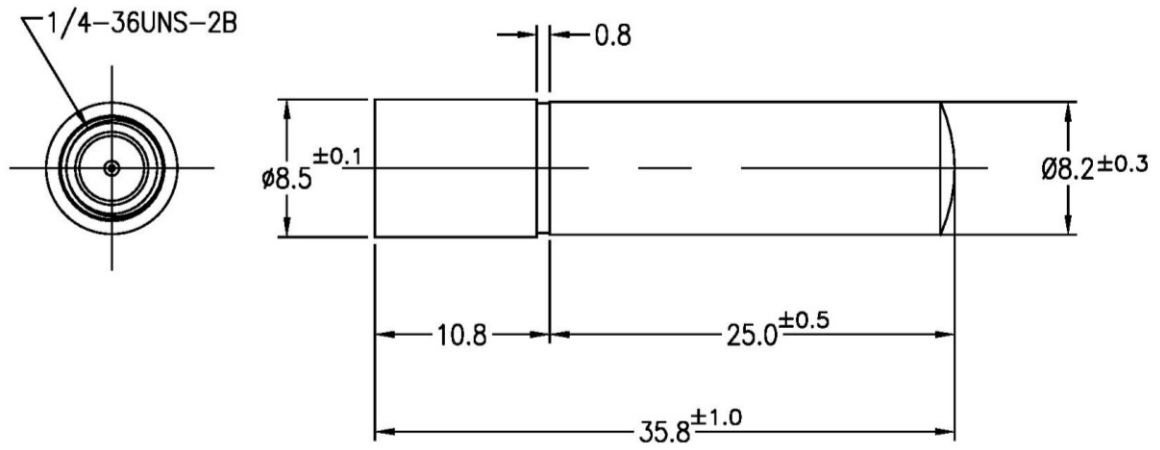

## 4. Packaging

60pcs TU.63 per tray  
 Tray dimensions: 298x240x17.4mm  
 Weight: 377g



1200pcs TU.63 per carton  
 Carton dimensions: 328x296x282mm  
 Weight: 8.3Kg

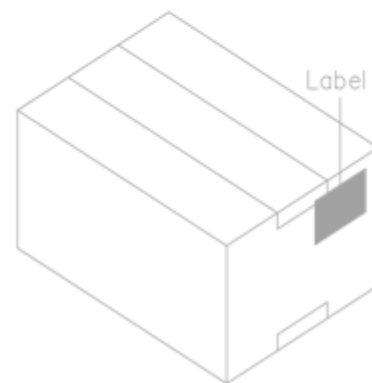

## 4. Antenna Characteristics

### 4.1 Test Setup

AUT



Vector Network Analyzer



In Free Space



On 150x90mm Eval Board



On 90x150mm Eval Board

## 4.2 Return Loss

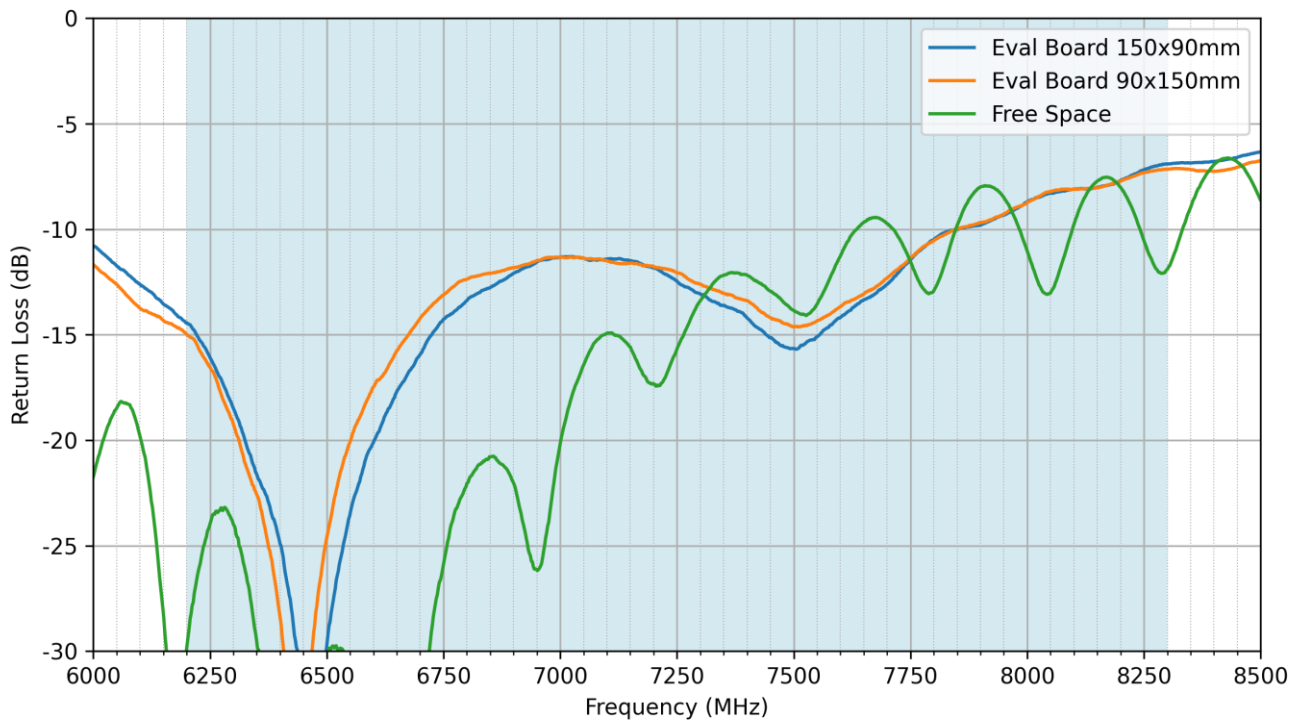

## 4.3 VSWR

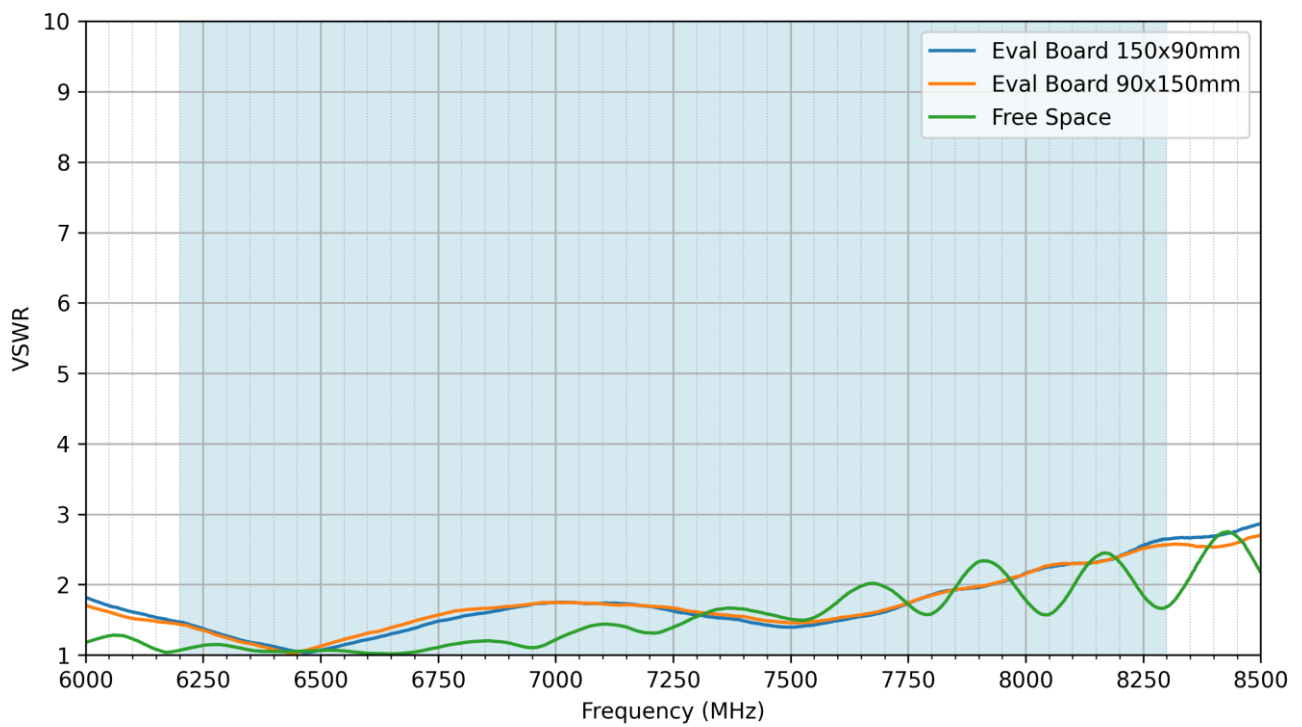

## 4.4 Efficiency

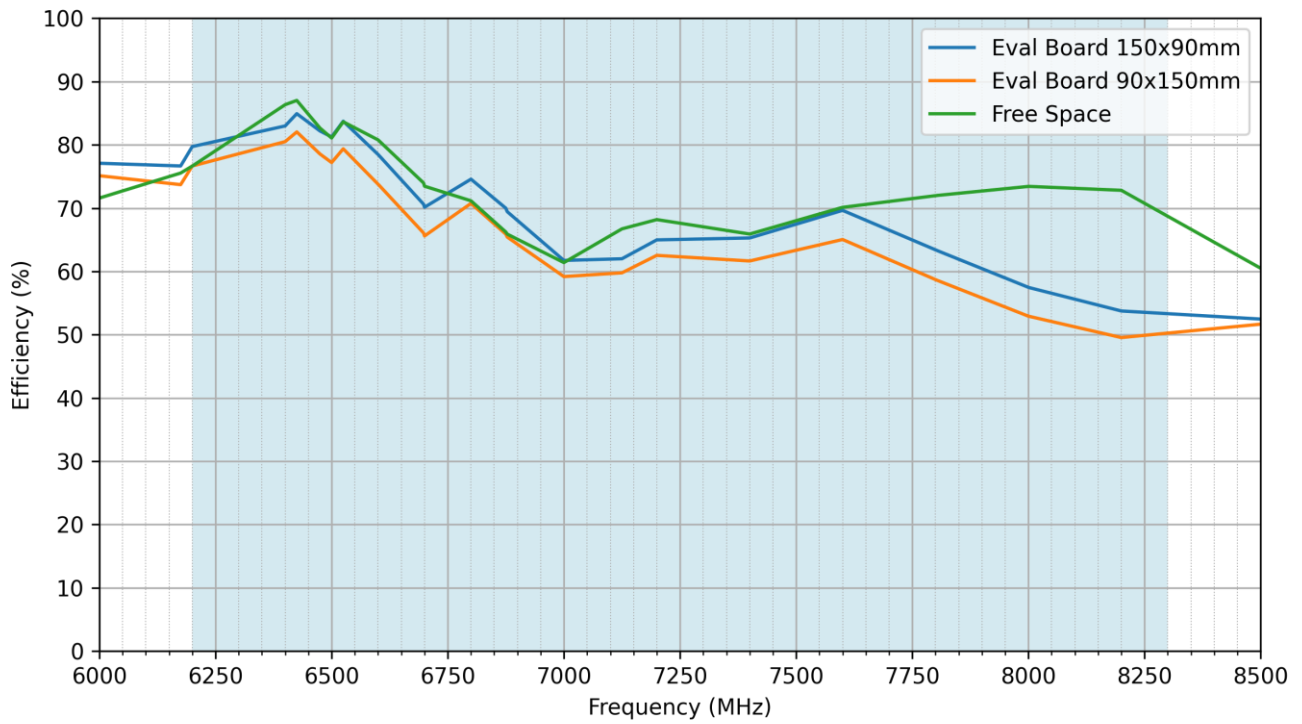

## 4.5 Average Gain

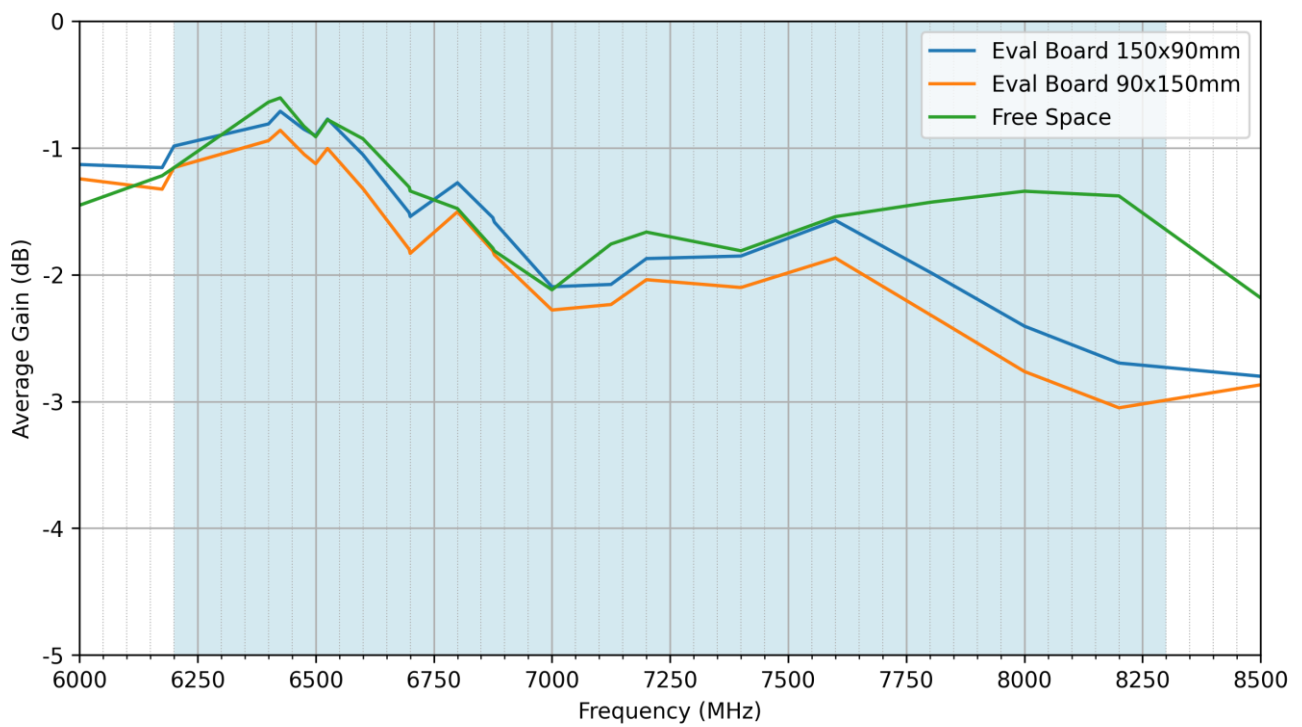

## 4.6 Peak Gain

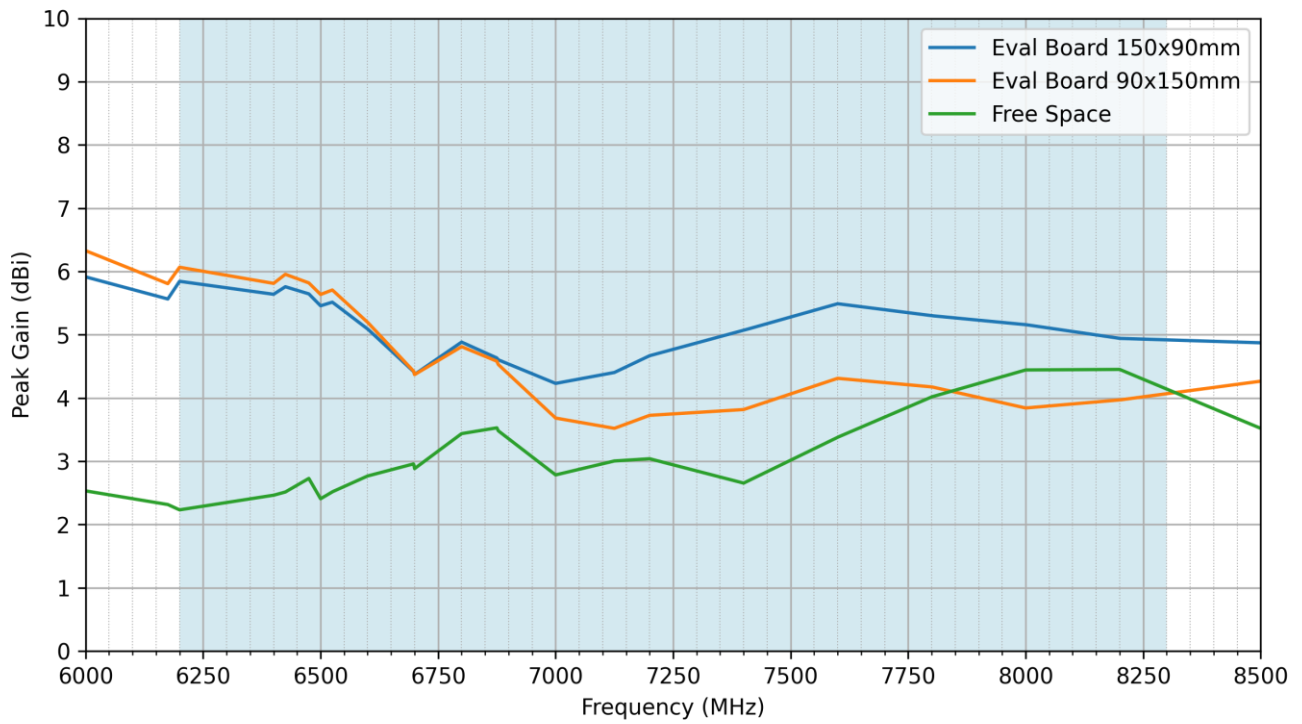

## 4.7 Group Delay

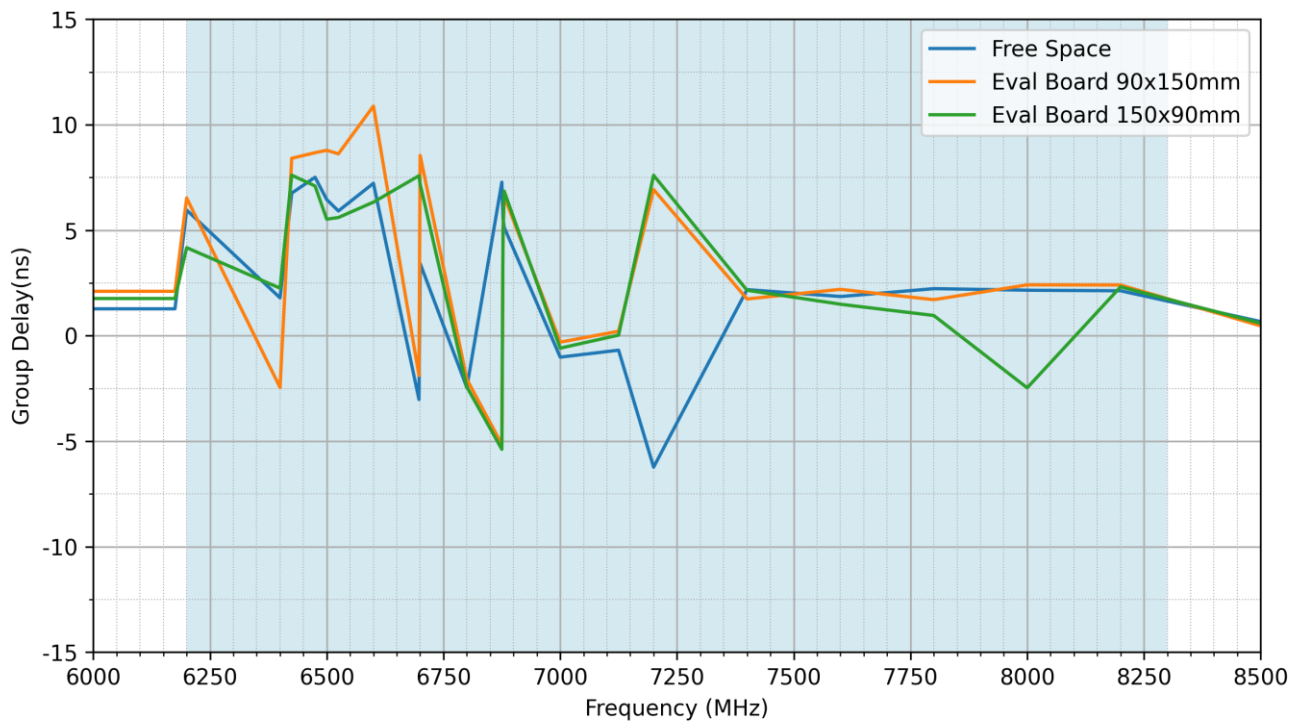



## 5. Radiation Patterns

### 5.1 Test Setup

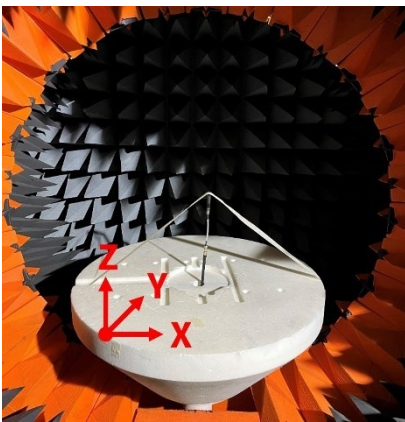
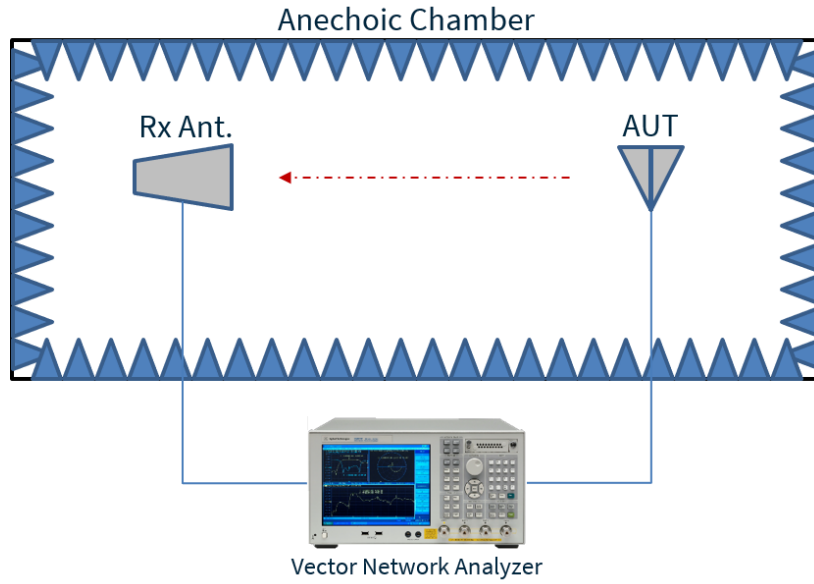

Free Space

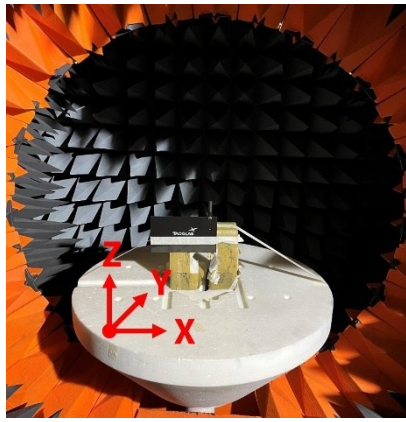

On 150x90mm Eval Board

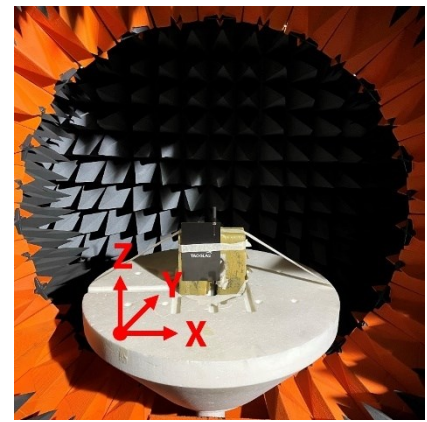

On 90x150mm Eval Board



5.2 Eval Board 150x90mm Patterns at 6500 MHz

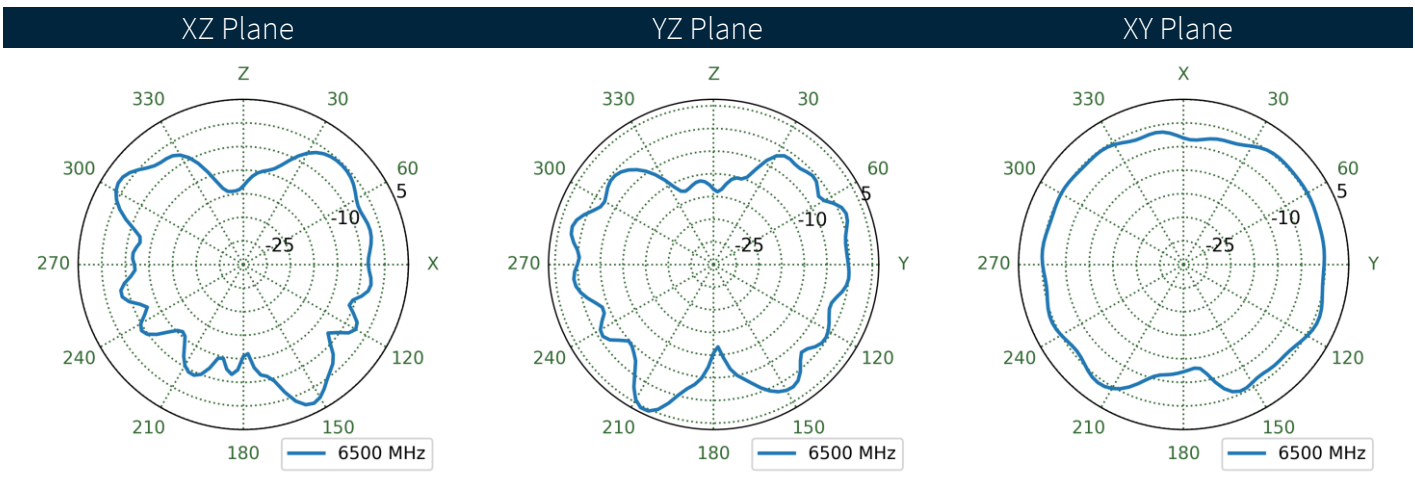
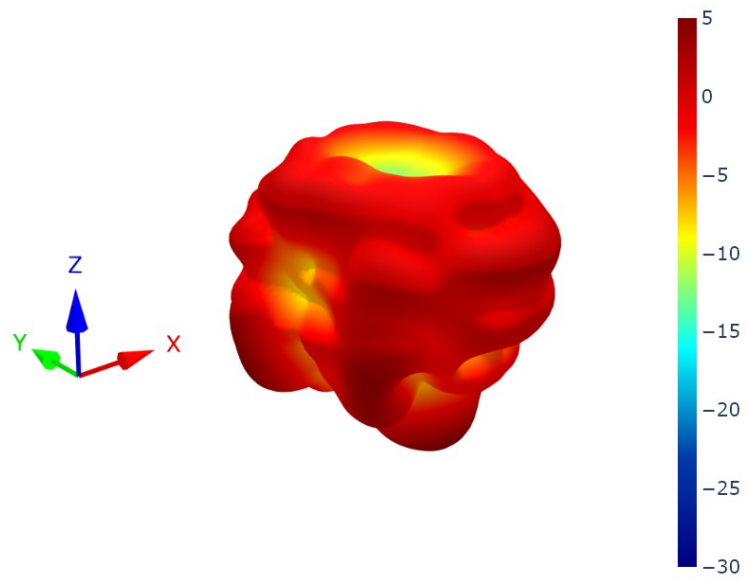

5.3 Eval Board 90x150mm Patterns at 6500 MHz

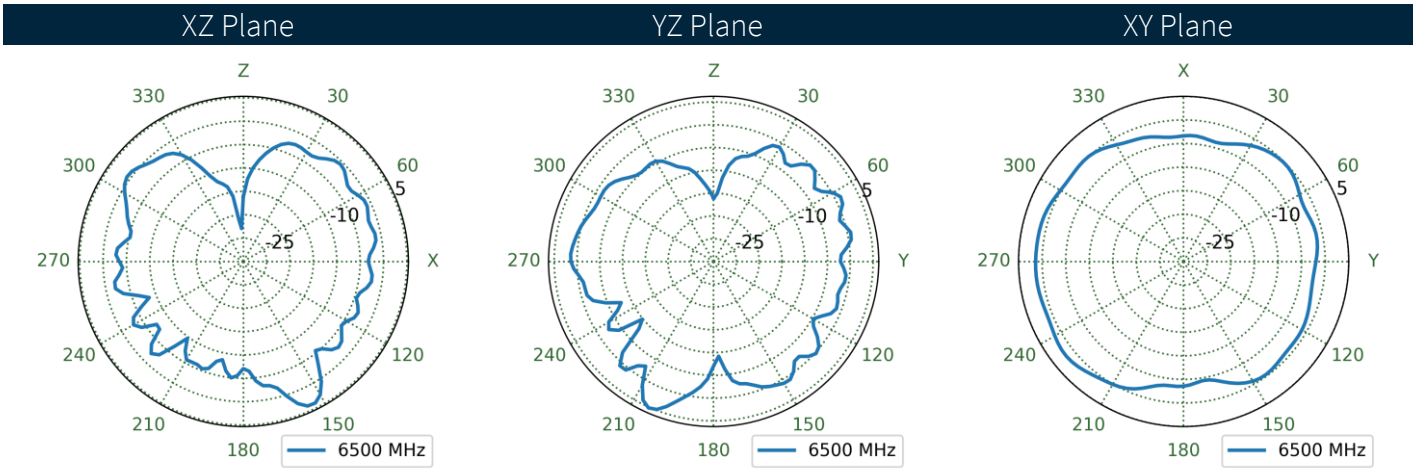
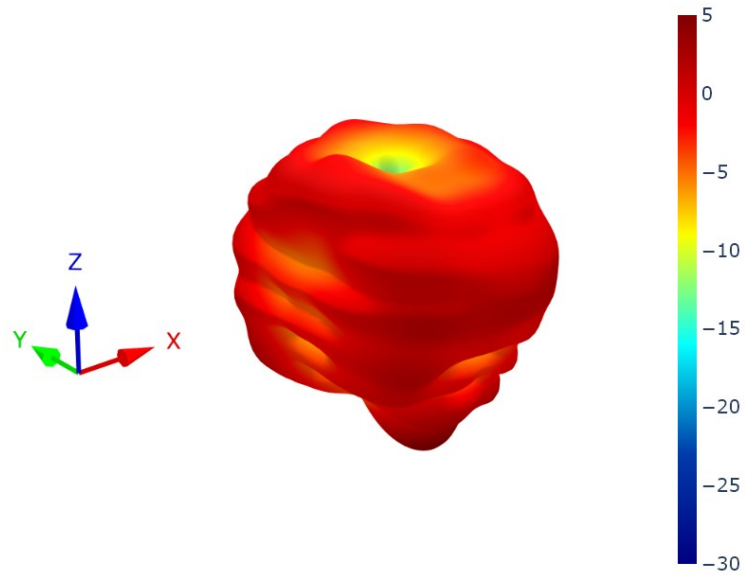

5.4 Free Space Patterns at 6500 MHz

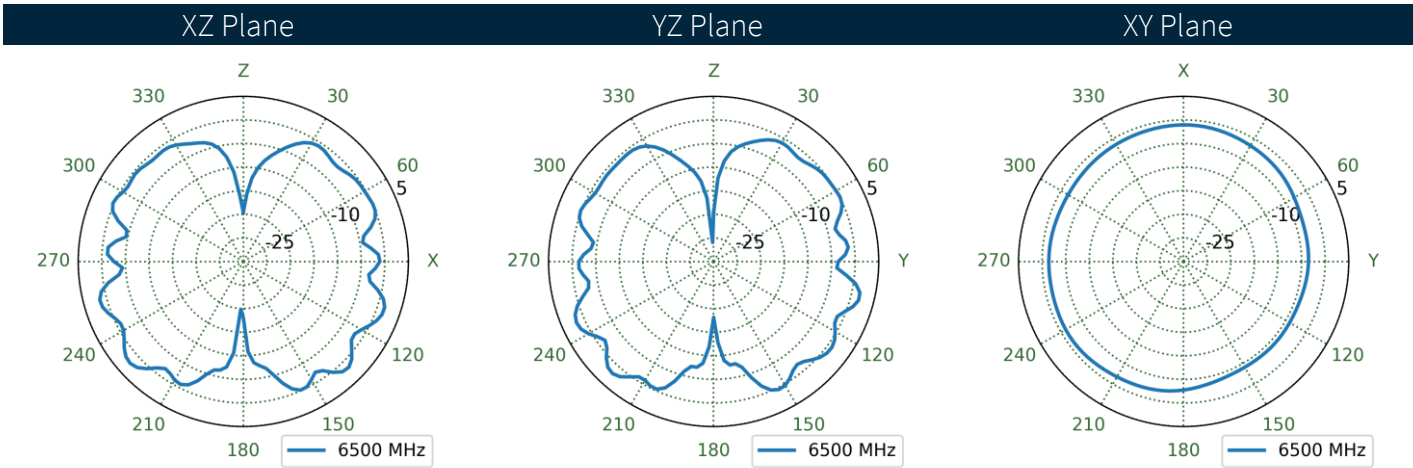
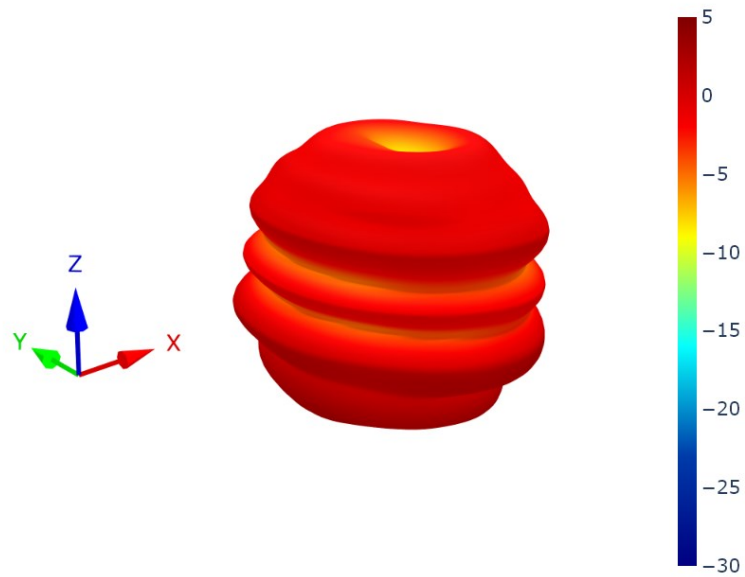

5.5 Eval Board 150x90mm Patterns at 6700 MHz

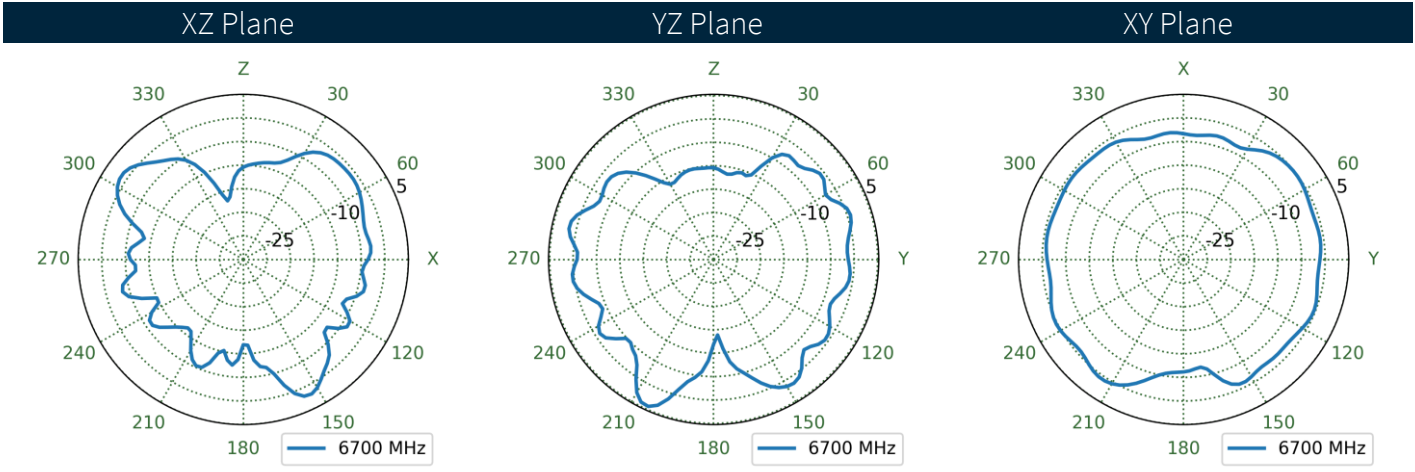
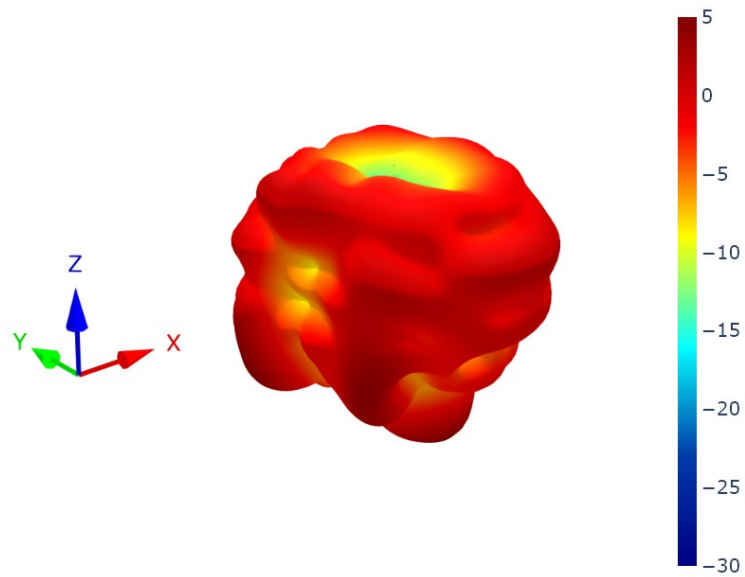

5.6 Eval Board 90x150mm Patterns at 6700 MHz

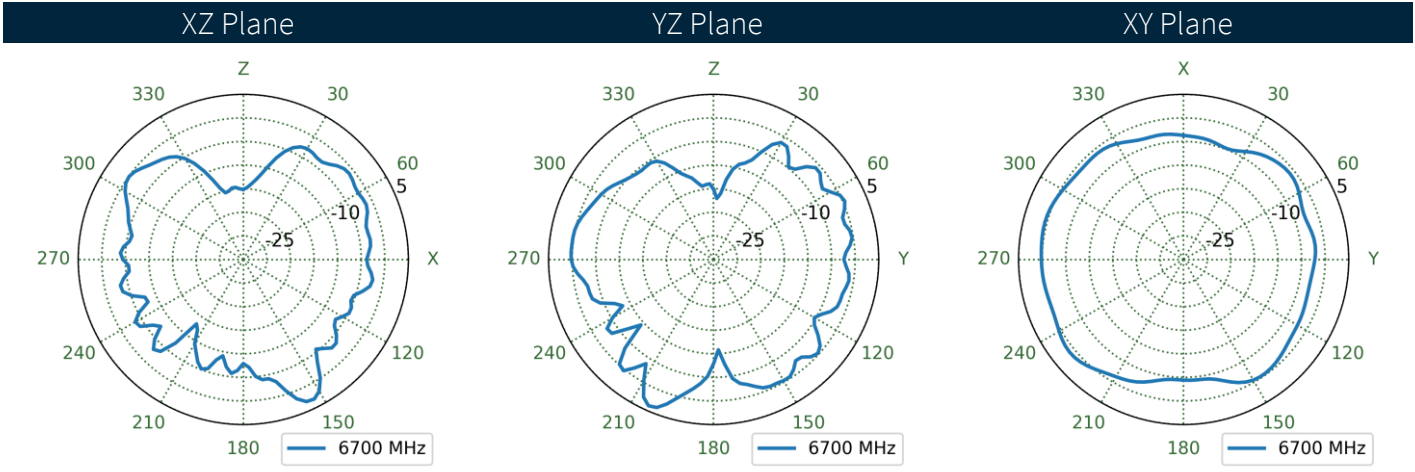
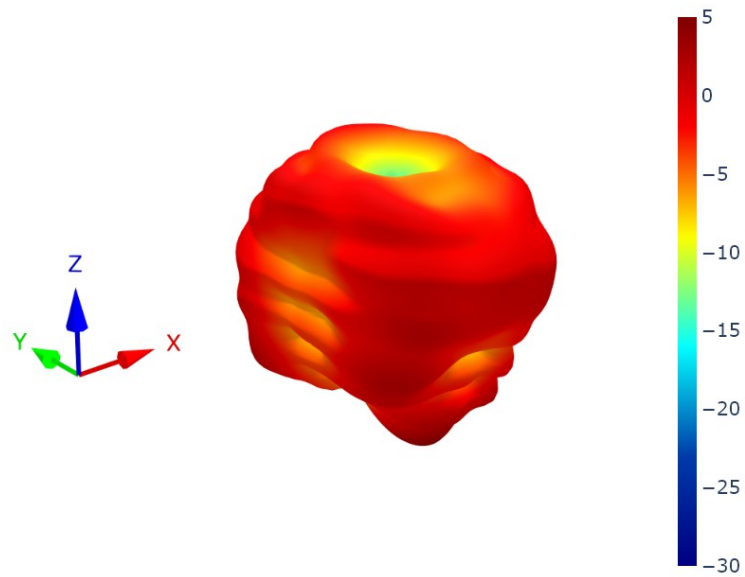

5.7 Free Space Patterns at 6700 MHz

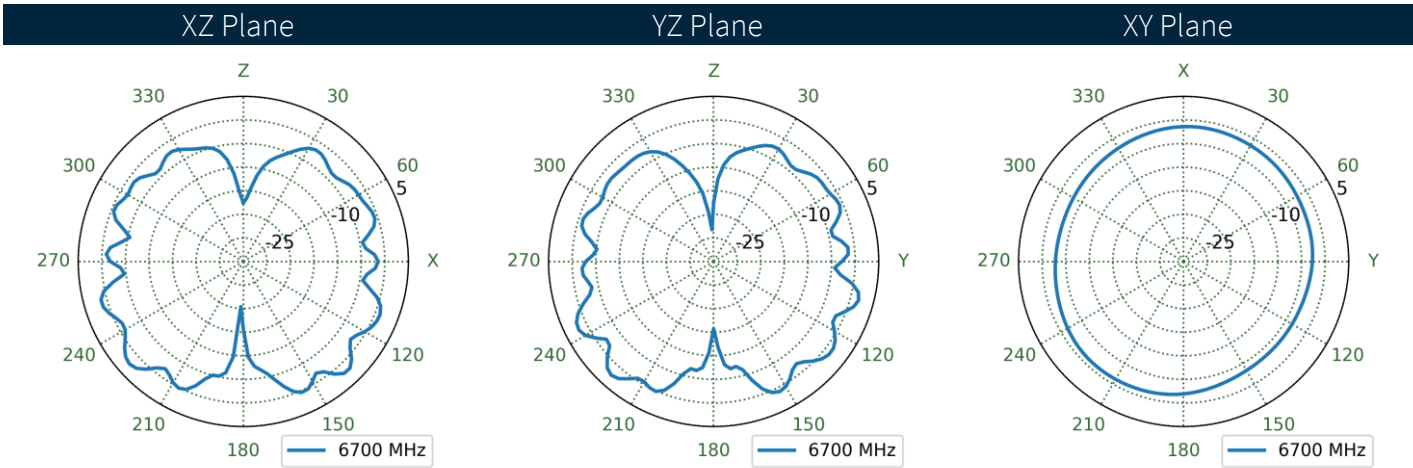
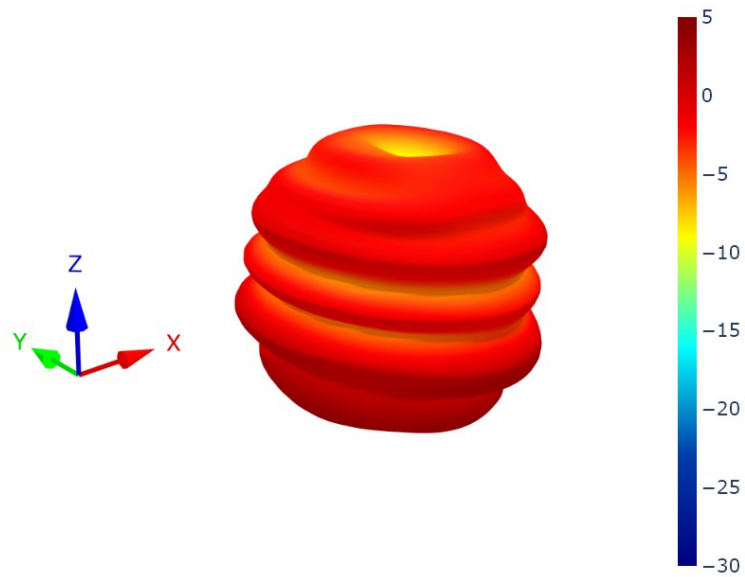

5.8 Eval Board 150x90mm Patterns at 7000 MHz

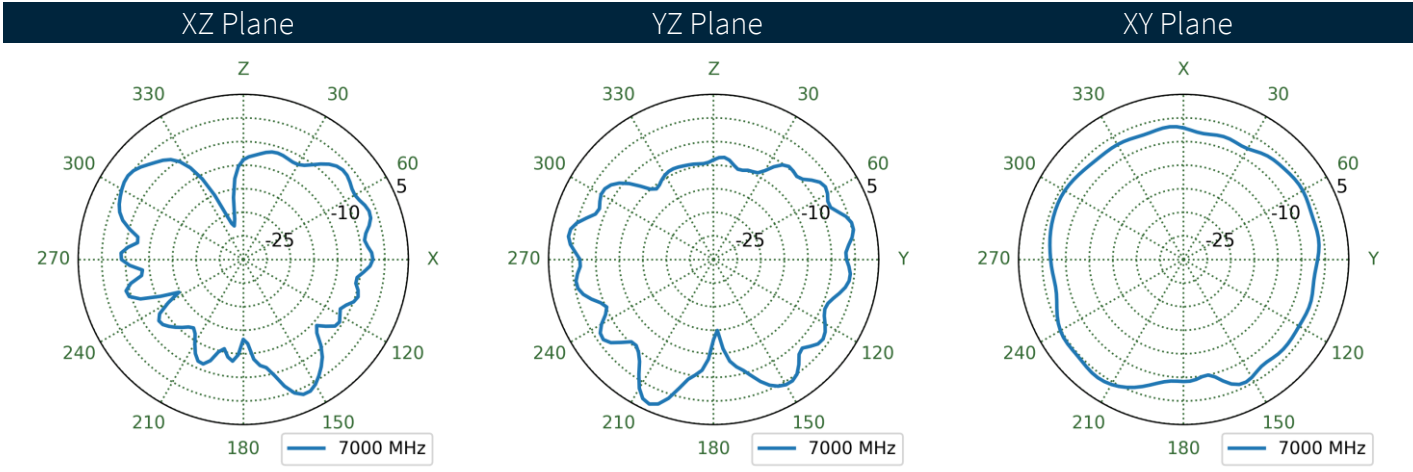
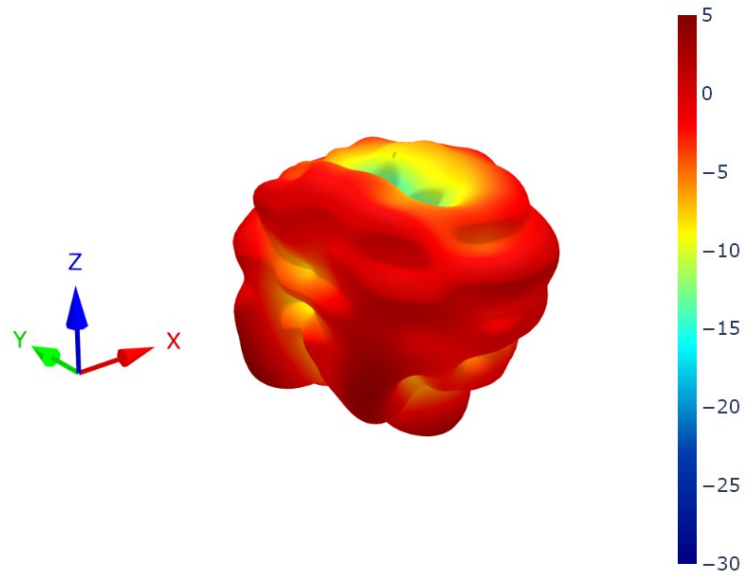



5.9 Eval Board 90x150mm Patterns at 7000 MHz

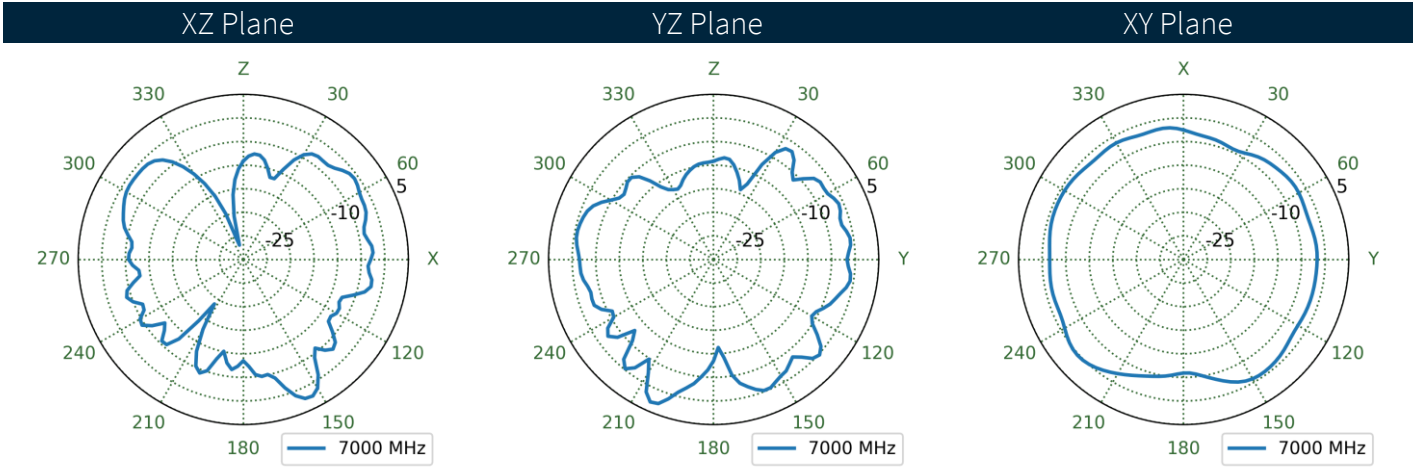
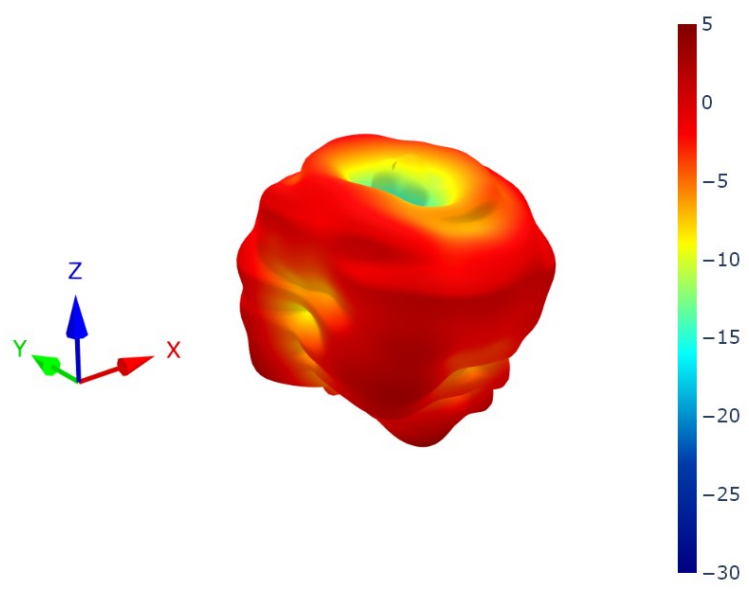

5.10 Free Space Patterns at 7000 MHz

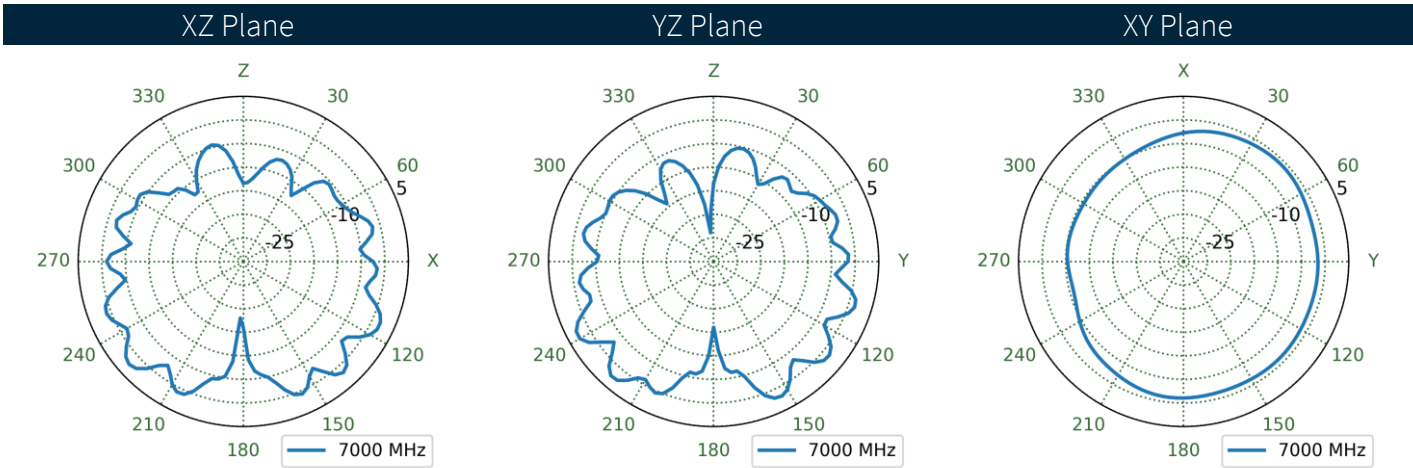
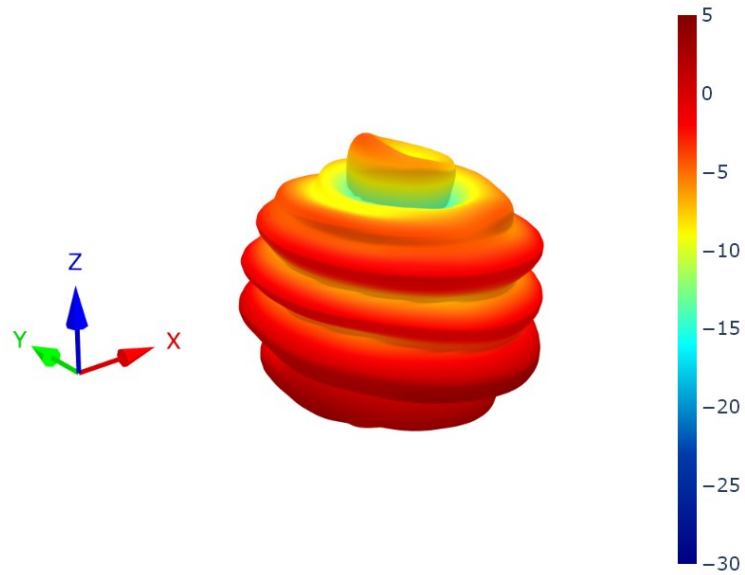

5.11 Eval Board 150x90mm Patterns at 7300 MHz

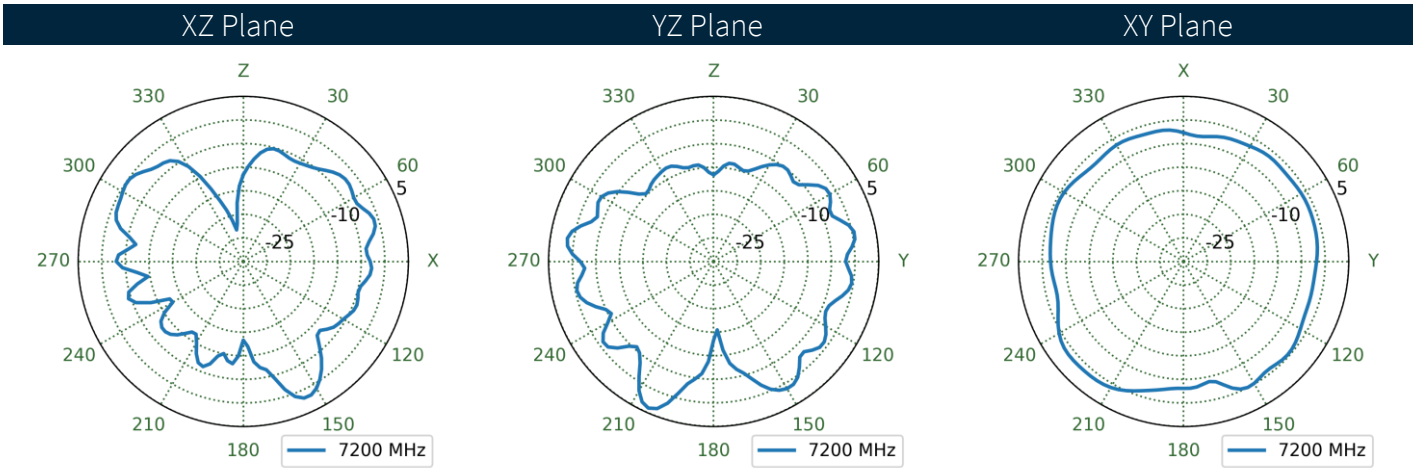
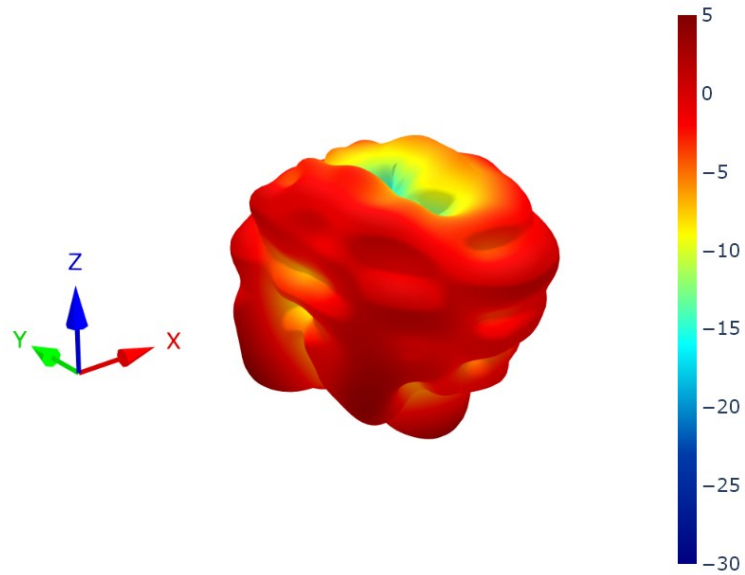

5.12 Eval Board 90x150mm Patterns at 7300 MHz

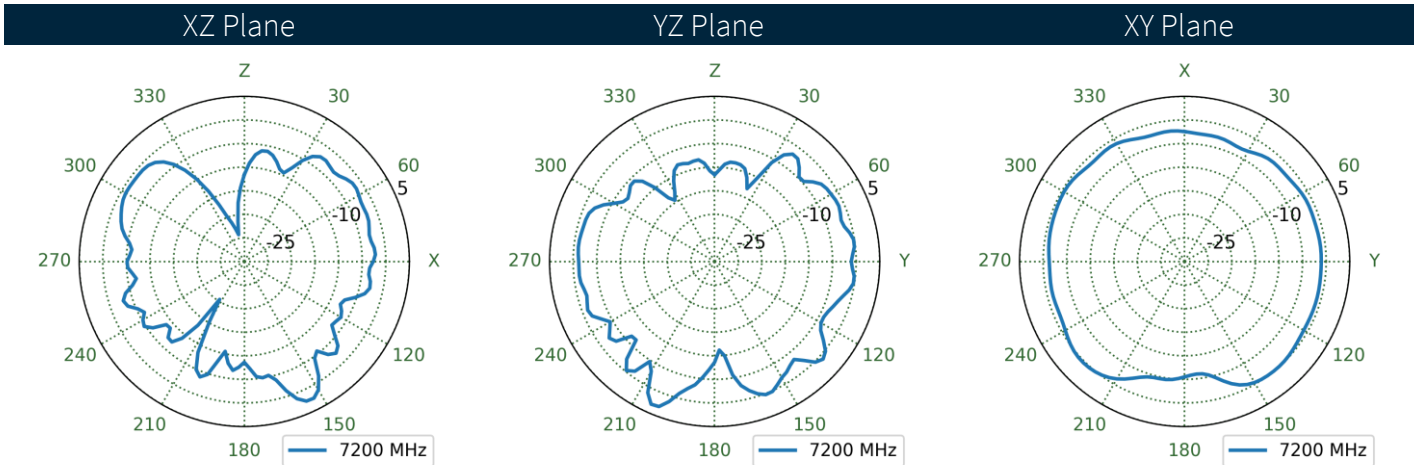
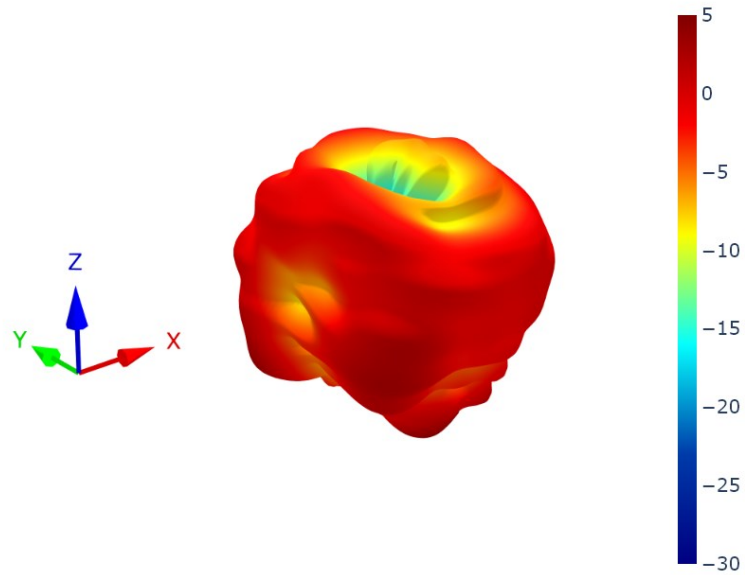

5.13 Free Space Patterns at 7300 MHz

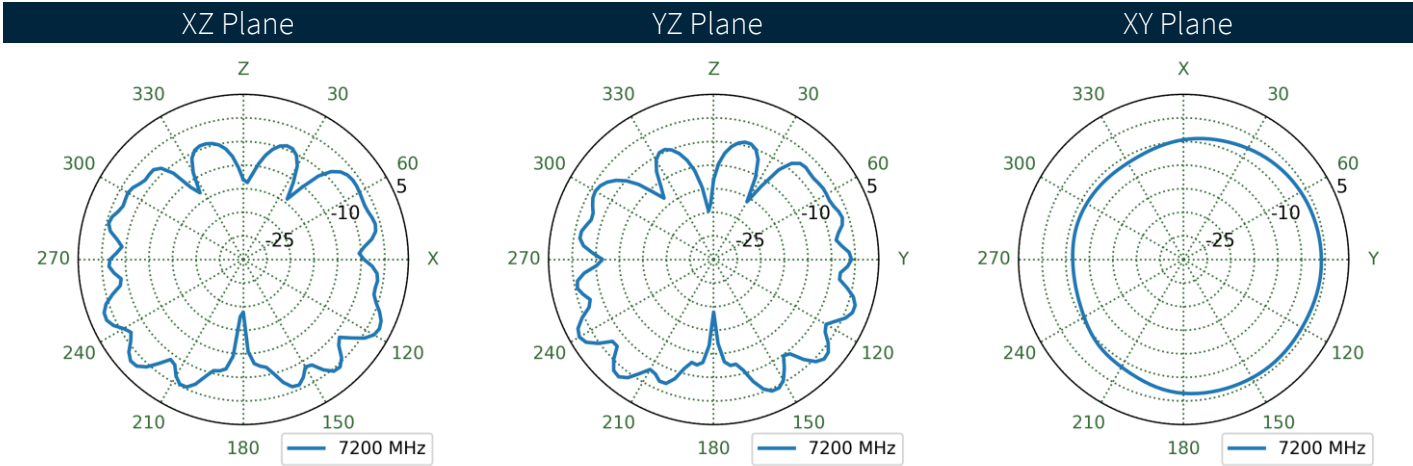
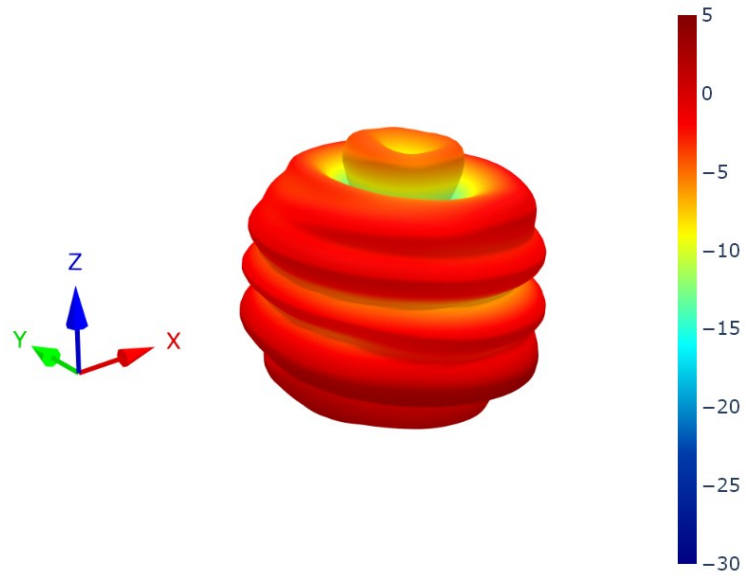

5.14 Eval Board 150x90mm Patterns at 7500 MHz

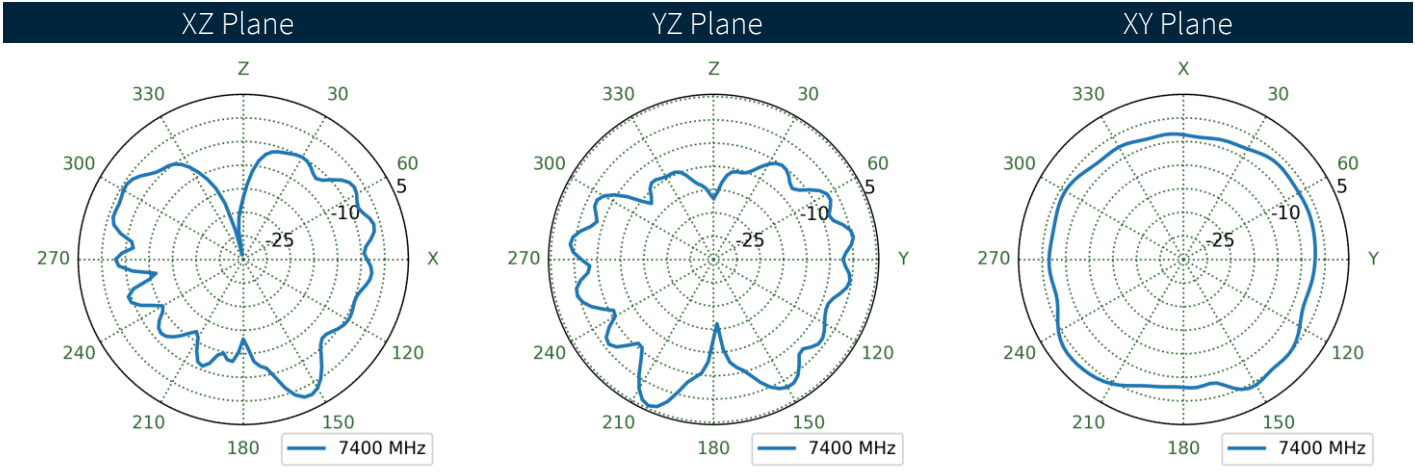
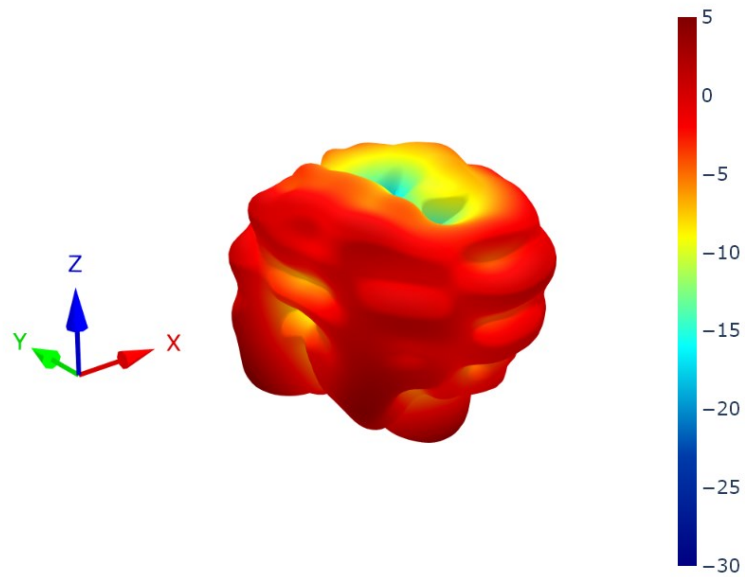

5.15 Eval Board 90x150mm Patterns at 7500 MHz

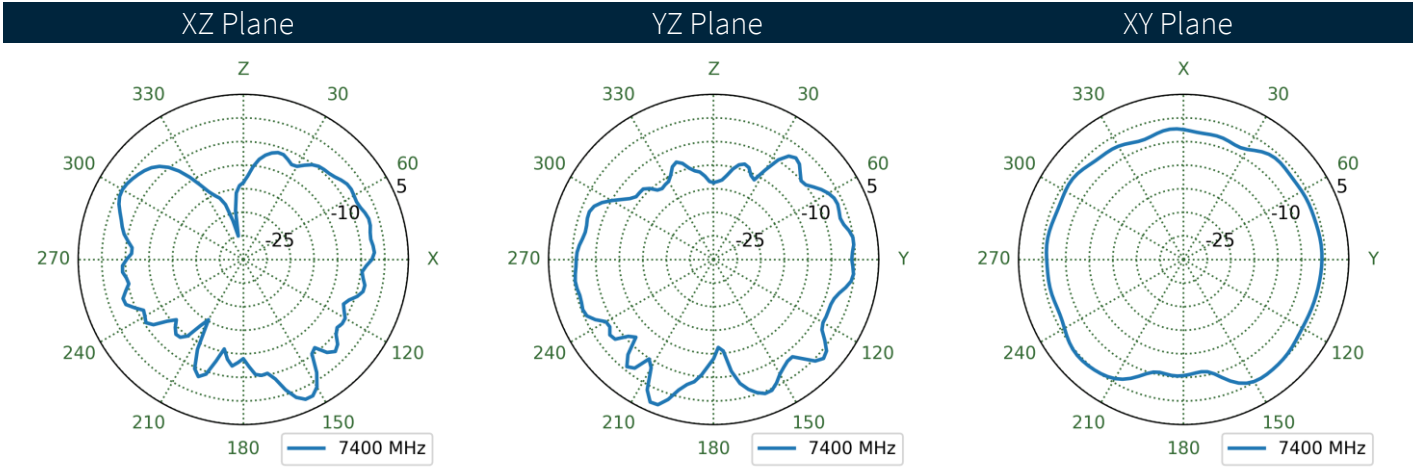
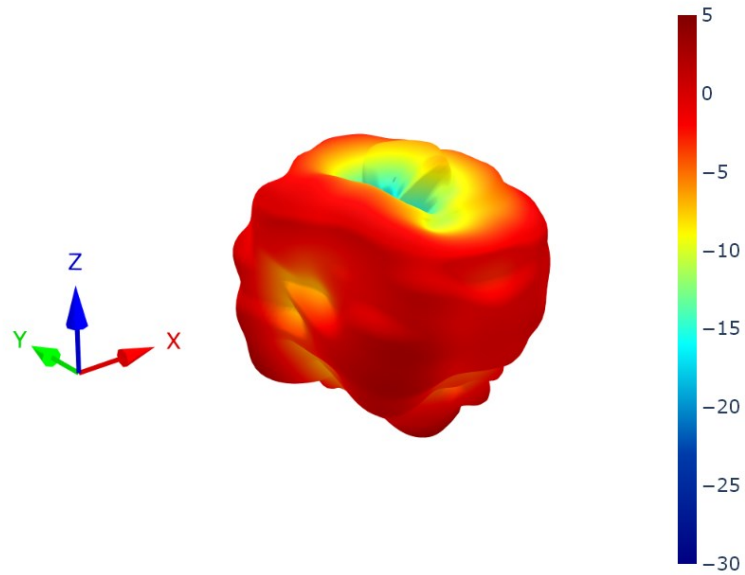



5.16 Free Space Patterns at 7500 MHz

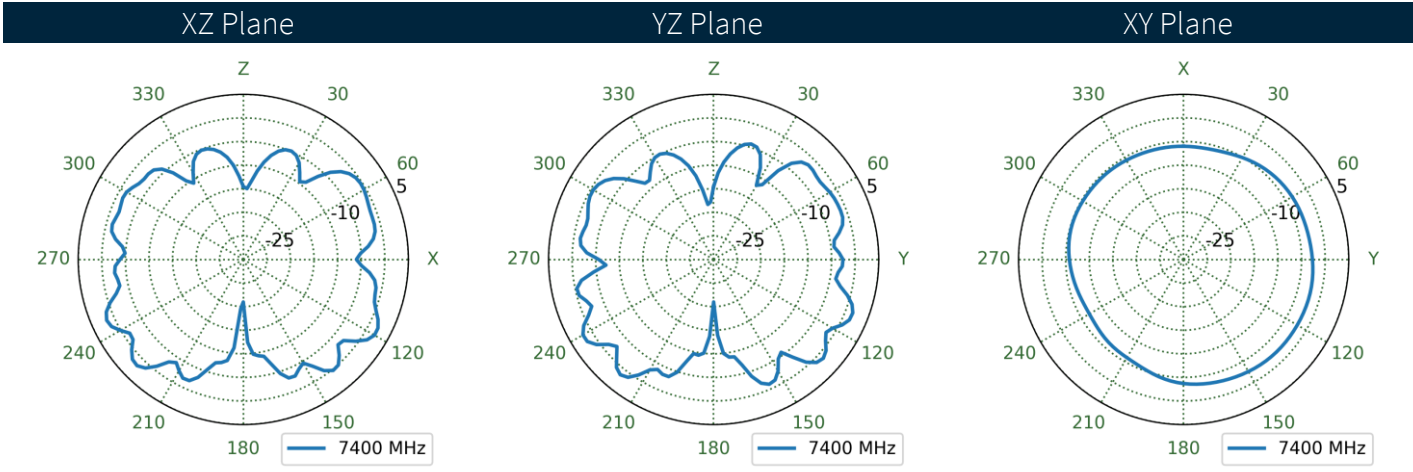
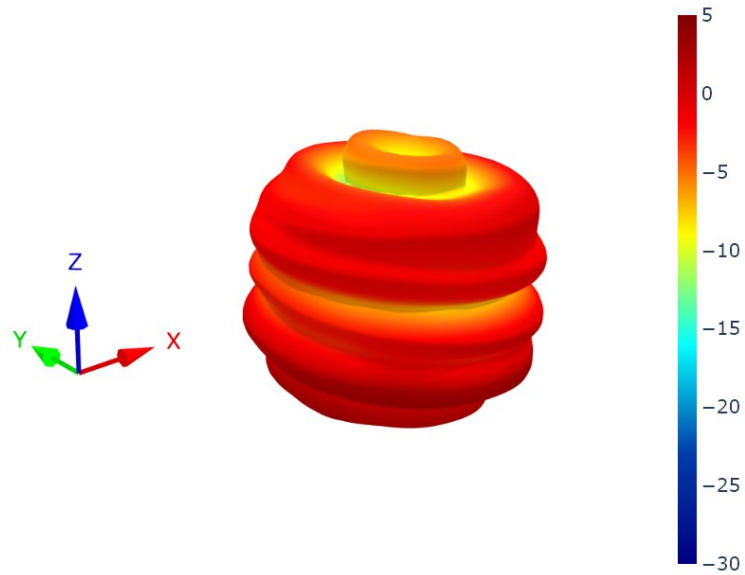

5.17 Eval Board 150x90mm Patterns at 8000 MHz

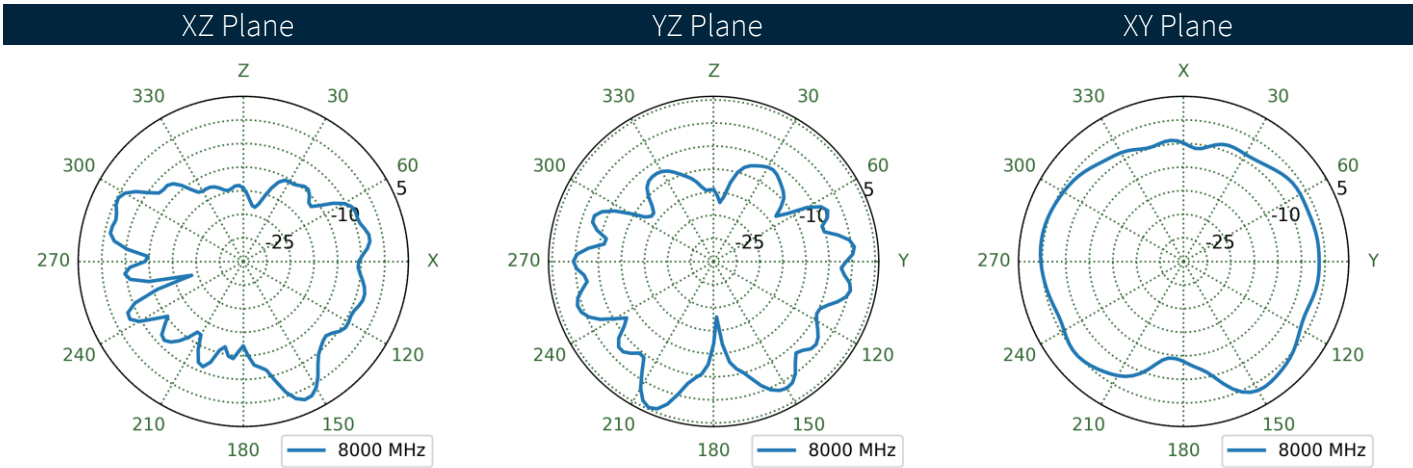
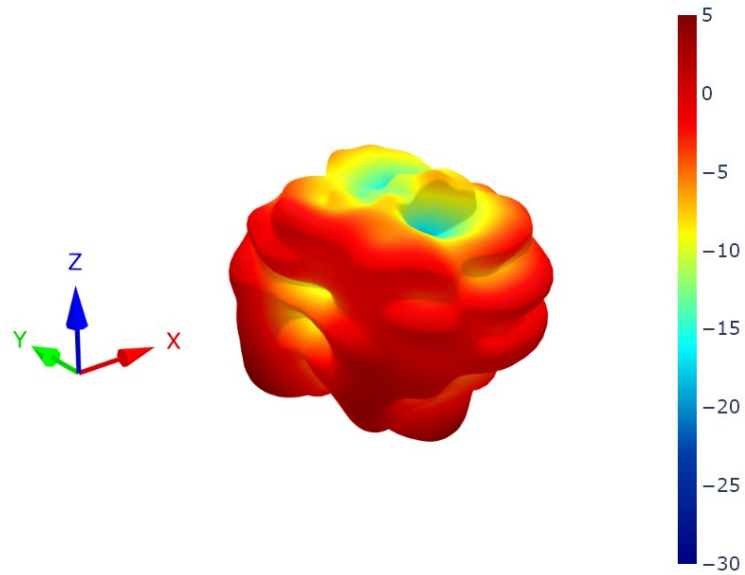

**5.18** Eval Board 90x150mm Patterns at 8000 MHz

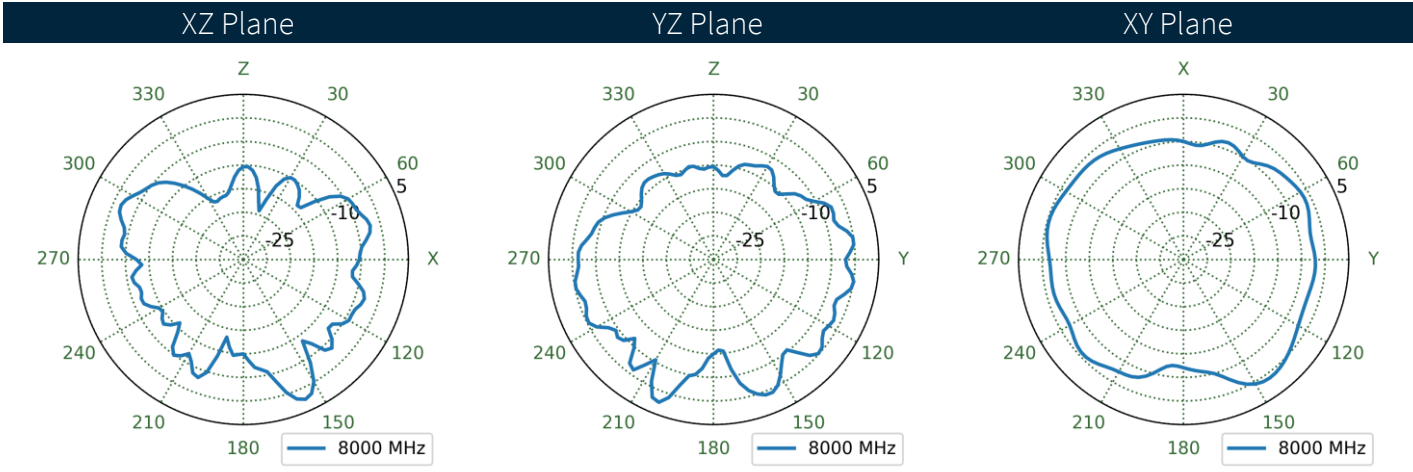
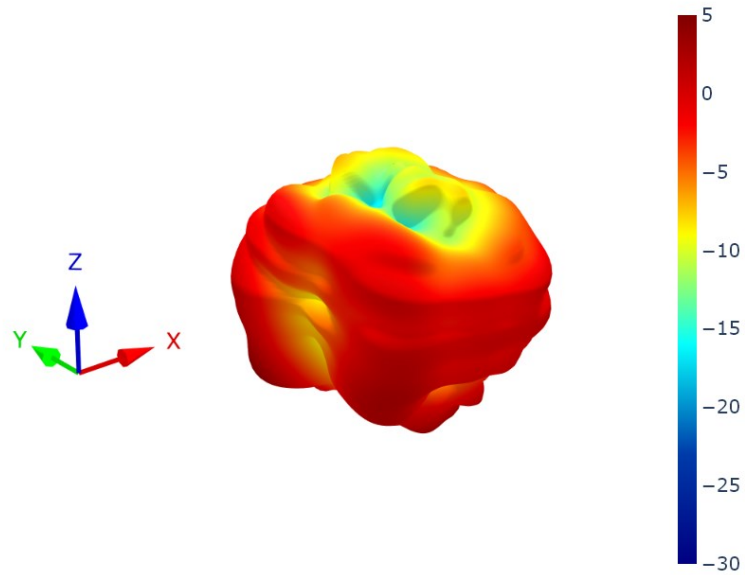

5.19 Free Space Patterns at 8000 MHz

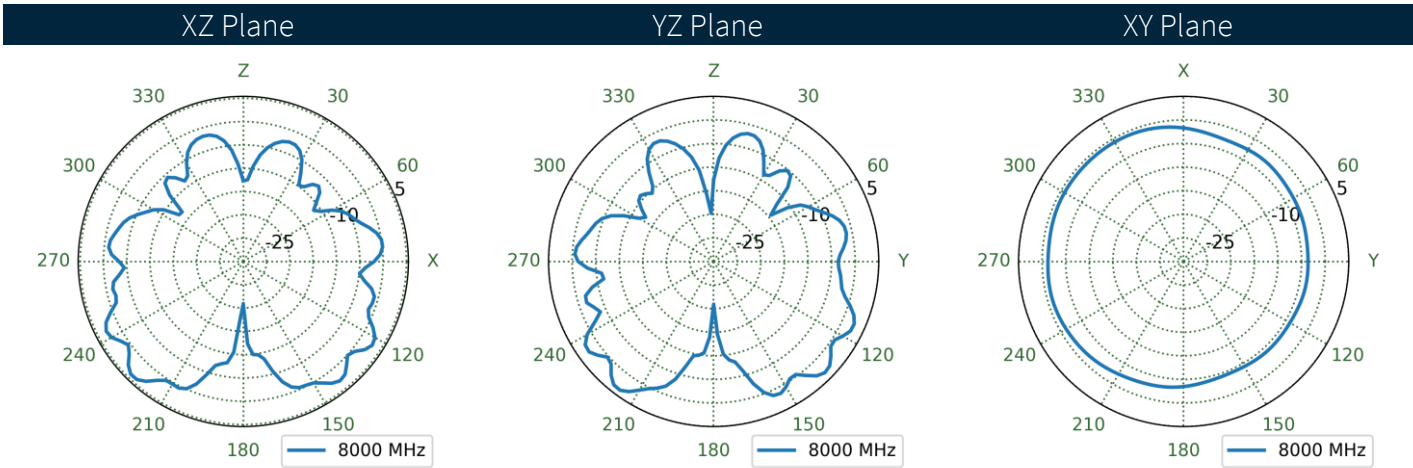
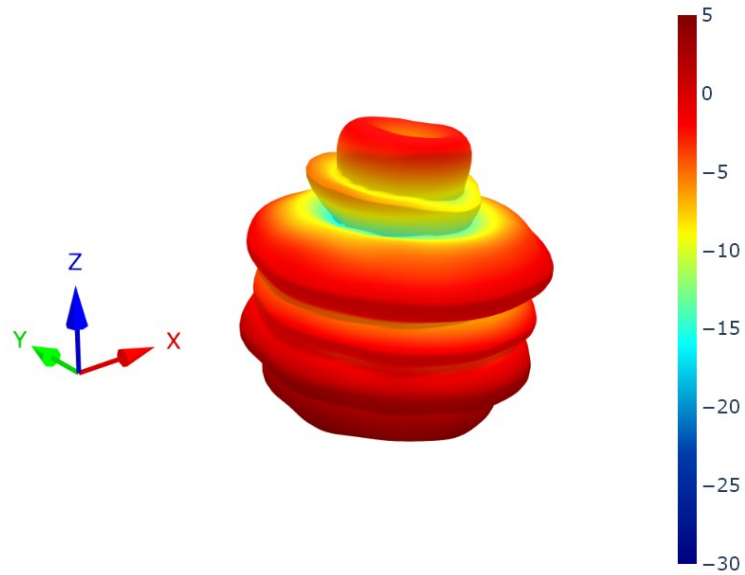

Changelog for the datasheet

**SPE-24-8-135 - TU.63.2111**

**Revision: B (Current Version)**

Date:	2024-07-19
Notes:	Power consumption, Enclosure material updated, IP Rating and group delay graph added.
Author:	Gary West

**Previous Revisions**

**Revision: A (Original First Release)**

Date:	2024-07-19
Notes:	Initial Release
Author:	Gary West

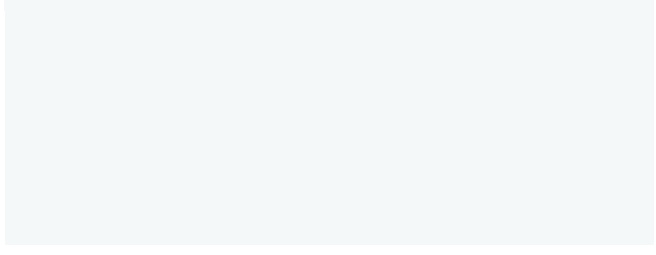
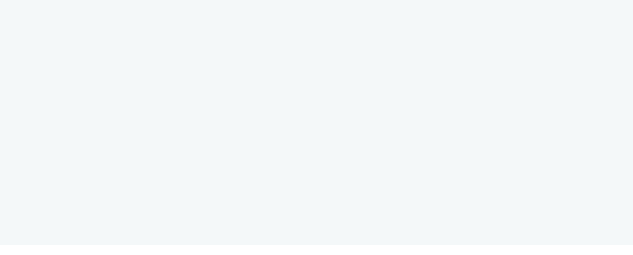
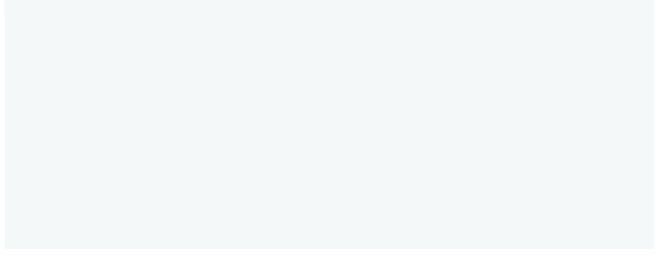
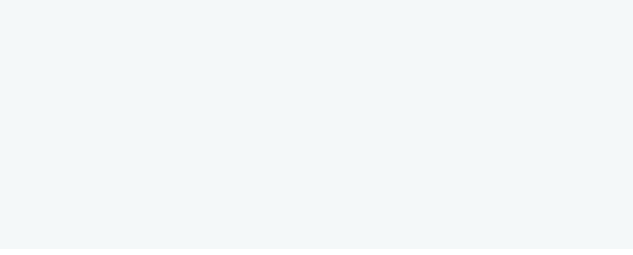
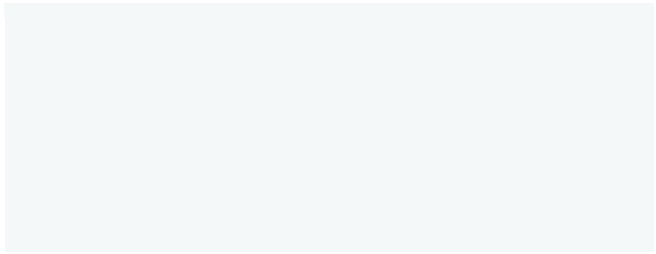
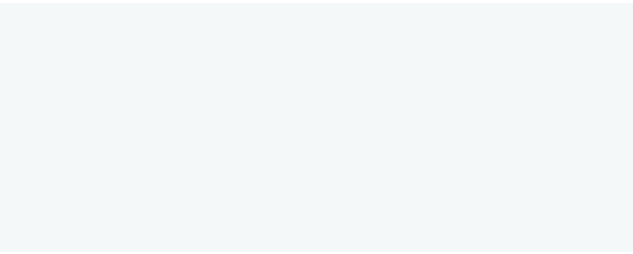
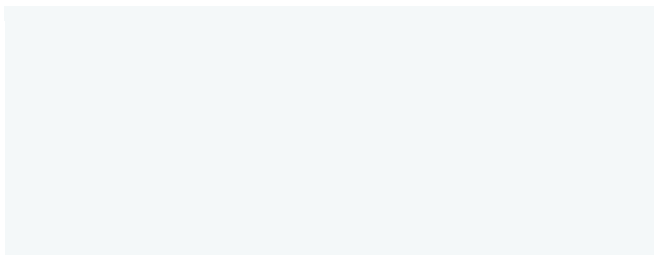
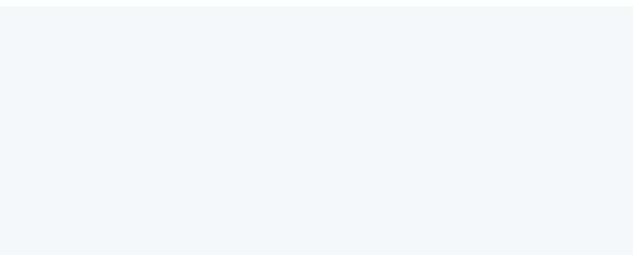



[www.taoglas.com](http://www.taoglas.com)

