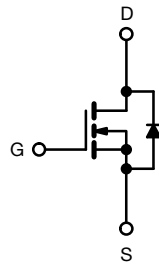
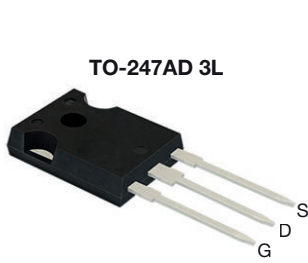


# MaxSiC™ 1200 V N-Channel SiC MOSFET



N-Channel MOSFET

**Marking Code:** 120A080FW

**FEATURES**

- Fast switching speed
- Short circuit withstand time 3  $\mu$ s
- Material categorization: for definitions of compliance please see [www.vishay.com/doc?99912](http://www.vishay.com/doc?99912)


**RoHS**  
 COMPLIANT  
 HALOGEN  
**FREE**
**APPLICATIONS**

- Charger
- Auxiliary motor drive
- DC/DC converter

PRODUCT SUMMARY	
$V_{DS}$ (V) at $T_J$ max.	1200
$R_{DS(on)}$ typ. (m $\Omega$ ) at 25 °C	$V_{GS} = 20$ V   80
$Q_g$ typ. (nC)	47.3
$I_D$ (A)	29
$C_{oss}$ typ. (pF)	50
$P_D$ (W)	139
Configuration	Single

ORDERING INFORMATION	
Package	TO-247AD 3L
Lead (Pb)-free and halogen-free	MXP120A080FW-GE3

ABSOLUTE MAXIMUM RATINGS ( $T_C = 25$ °C, unless otherwise noted)				
PARAMETER		SYMBOL	LIMIT	UNIT
Drain-source voltage <sup>a</sup>		$V_{DS}$	1200	V
Gate-source voltage		$V_{GS}$	-10 / +22	
Recommended operation voltage of gate-source		$V_{GSOP}$	-5 / +20	
Continuous drain current	$T_C = 25$ °C	$I_D$	29	A
	$T_C = 100$ °C	$I_D$	18	
Pulsed drain current <sup>b</sup>		$I_{DM}$	58	
Short-circuit withstand time <sup>c</sup>		$T_{SC}$	3	$\mu$ s
Maximum power dissipation	$T_C = 25$ °C	$P_D$	139	W
	$T_C = 100$ °C	$P_D$	56	
Operating junction and storage temperature range		$T_J, T_{stg}$	-55 to +150	°C
Soldering recommendations (peak temperature)	For 10 s		260	°C

**Notes**

- $T_J = 25$  °C to 150 °C
- Repetitive rating; pulse width limited by maximum junction temperature
- Verified by the design / characterization

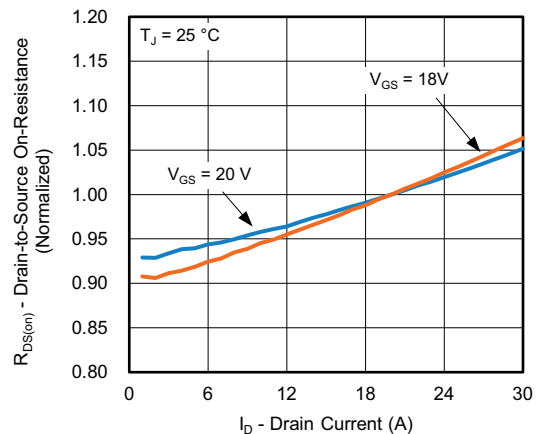
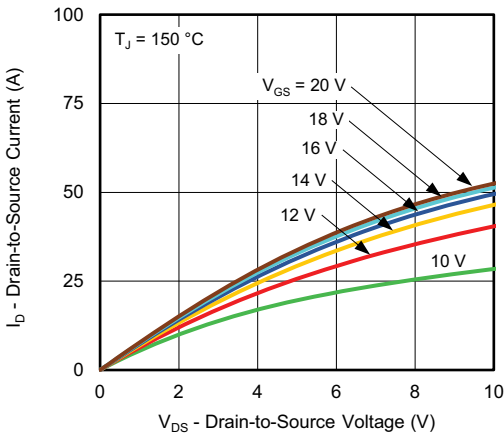
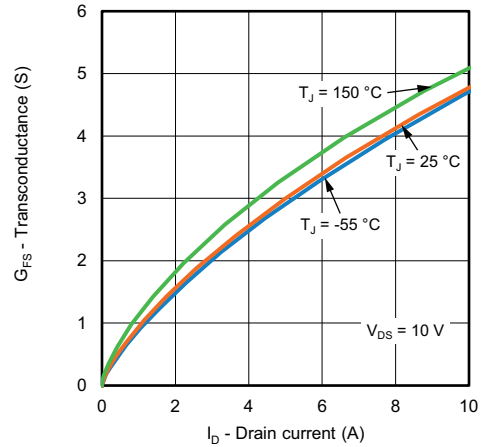
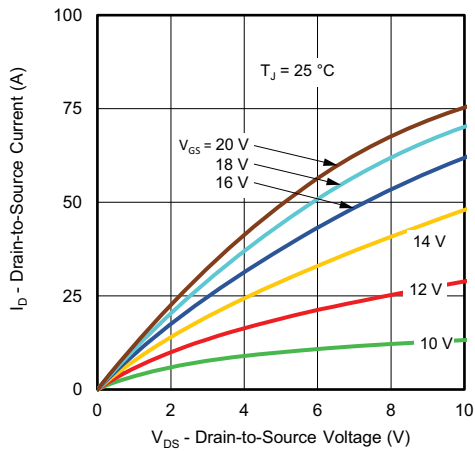
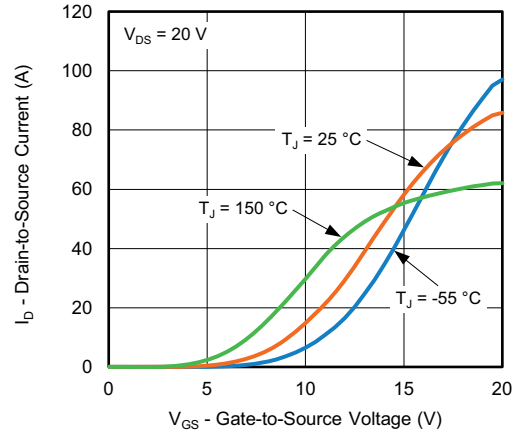
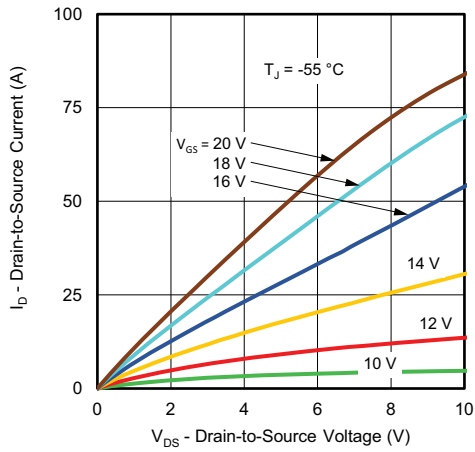


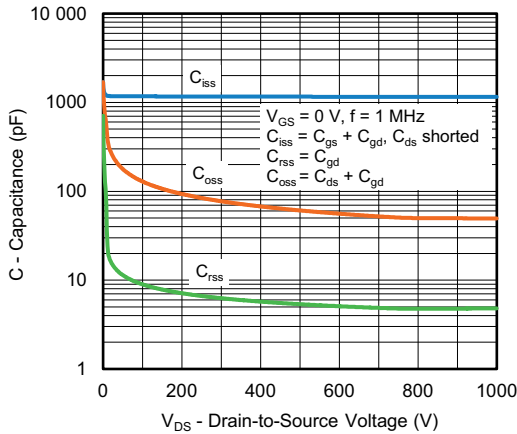
<b>THERMAL RESISTANCE RATINGS</b>				
PARAMETER	SYMBOL	TYP.	MAX.	UNIT
Maximum junction-to-ambient	$R_{thJA}$	-	40	°C/W
Maximum junction-to-case (drain)	$R_{thJC}$	-	0.9	

<b>SPECIFICATIONS</b> ( $T_J = 25\text{ °C}$ , unless otherwise noted)							
PARAMETER	SYMBOL	TEST CONDITIONS	MIN.	TYP.	MAX.	UNIT	
<b>Static</b>							
Drain-source breakdown voltage	$V_{DS}$	$V_{GS} = 0\text{ V}, I_D = 1\text{ mA}$	1200	-	-	V	
Gate-source threshold voltage (N)	$V_{GS(th)}$	$V_{DS} = V_{GS}, I_D = 5\text{ mA}$	-	2.69	-	V	
		$V_{DS} = V_{GS}, I_D = 5\text{ mA}, T_J = 150\text{ °C}$	-	1.86	-	V	
Gate-source leakage	$I_{GSS}$	$V_{GS} = +22\text{ V}, V_{DS} = 0\text{ V}$	-	-	100	nA	
		$V_{GS} = -10\text{ V}, V_{DS} = 0\text{ V}$	-	-	-100		
Zero gate voltage drain current	$I_{DSS}$	$V_{DS} = 960\text{ V}, V_{GS} = 0\text{ V}$	-	-	10	μA	
Drain-source on-state resistance	$R_{DS(on)}$	$V_{GS} = 20\text{ V}, I_D = 20\text{ A}$	-	80	100	mΩ	
		$V_{GS} = 20\text{ V}, I_D = 20\text{ A}, T_J = 150\text{ °C}$	-	128	160		
		$V_{GS} = 18\text{ V}, I_D = 20\text{ A}$	-	95	119		
		$V_{GS} = 18\text{ V}, I_D = 20\text{ A}, T_J = 150\text{ °C}$	-	140	175		
<b>Dynamic</b>							
Input capacitance	$C_{iss}$	$V_{GS} = 0\text{ V}, V_{DS} = 800\text{ V}, f = 1\text{ MHz}$	-	1156	-	pF	
Output capacitance	$C_{oss}$		-	50	-		
Reverse transfer capacitance	$C_{rss}$		-	5	-		
Coss Stored Energy	$E_{oss}$		-	20	-	μJ	
Total gate charge	$Q_g$	$V_{GS} = 18\text{ V}, I_D = 20\text{ A}, V_{DS} = 800\text{ V}$	-	47.3	-	nC	
Gate-source charge	$Q_{gs}$		-	14.2	-		
Gate-drain charge	$Q_{gd}$		-	17.8	-		
Gate Resistance	$R_g$	$V_{DS} = 0\text{ V}, f = 1\text{ MHz}$	-	9.8	-	Ω	
<b>Switching Characteristics</b>							
Turn-on delay time	$t_{d(on)}$	$V_{GS} = -5\text{ V} \sim 18\text{ V}, I_D = 20\text{ A}, V_{DS} = 800\text{ V}, R_{g(ext)} = 4.4\text{ Ω}$	-	25.6	-	ns	
Rise time	$t_r$		-	15.6	-		
Turn-off delay time	$t_{d(off)}$		-	16	-		
Fall time	$t_f$		-	9	-		
Turn-on switching energy	$E_{on}$			-	386	-	μJ
Turn-off switching energy	$E_{off}$			-	37	-	
<b>Body Diode Ratings and Characteristic</b>							
Forward diode voltage	$V_{SD}$	$V_{GS} = -5\text{ V}, I_{SD} = 10\text{ A}, T_J = 25\text{ °C}$	-	5.1	-	V	
Continuous diode forward current	$I_{SD}$	$V_{GS} = -5\text{ V}, T_J = 25\text{ °C}$	-	-	21	A	
Pulsed diode forward current	$I_{SDM}$		-	-	58		
Reverse recovery time	$t_{rr}$	$V_{GS} = -5\text{ V}, I_{SD} = 20\text{ A}, V_R = 800\text{ V}, di/dt = 1000\text{ A/μs}$	-	14	-	ns	
Reverse recovery charge	$Q_{rr}$		-	35	-	nC	
Reverse recovery current	$I_{rrm}$		-	4.5	-	A	

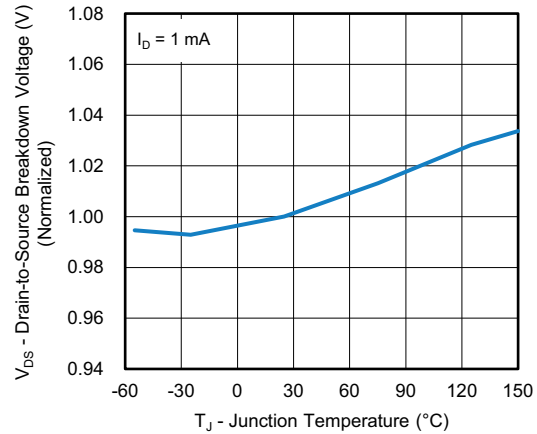


TYPICAL CHARACTERISTICS (25 °C, unless otherwise noted)

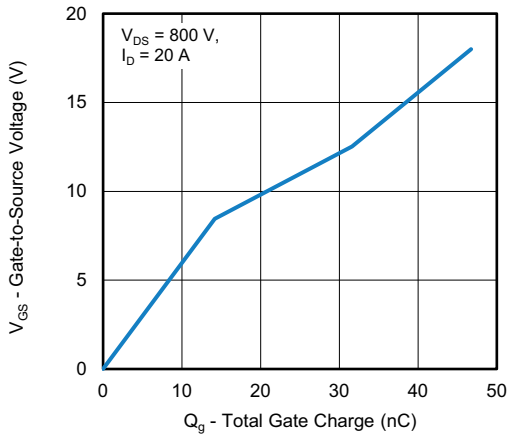




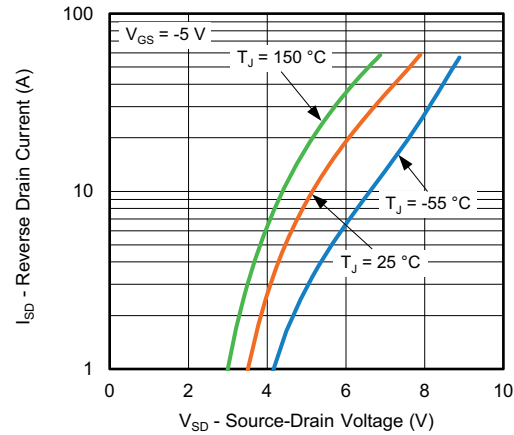
**Fig. 7 - Typical Capacitance vs. Drain-to-Source Voltage**



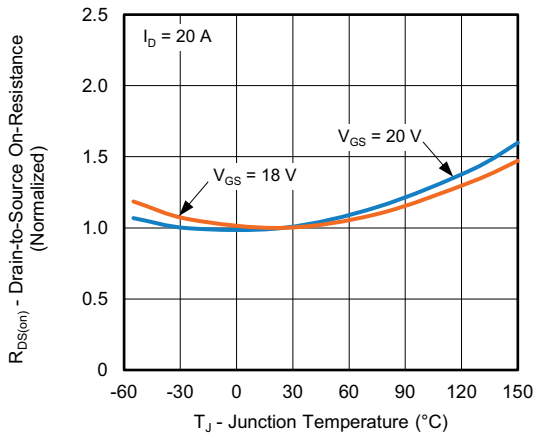
**Fig. 10 - Drain-to-Source Voltage vs. Temperature**



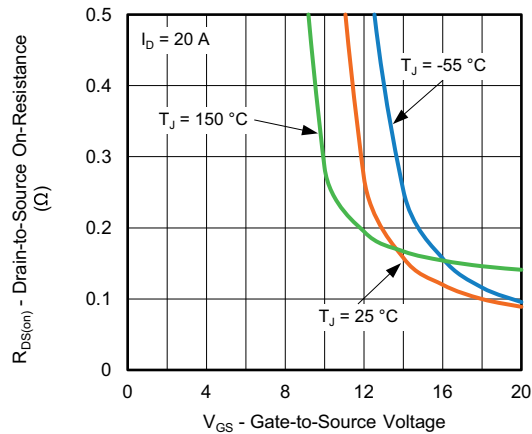
**Fig. 8 - Typical Gate Charge vs. Gate-to-Source Voltage**



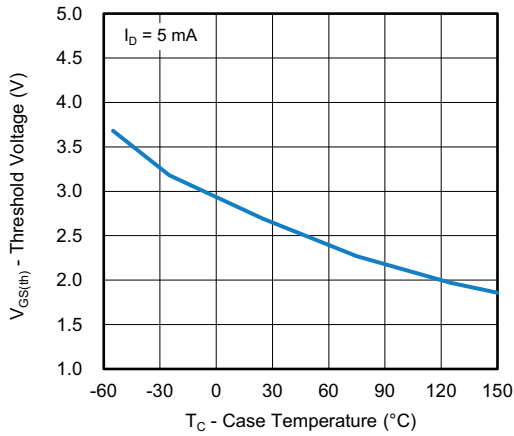
**Fig. 11 - Typical Source-Drain Diode Forward Voltage**



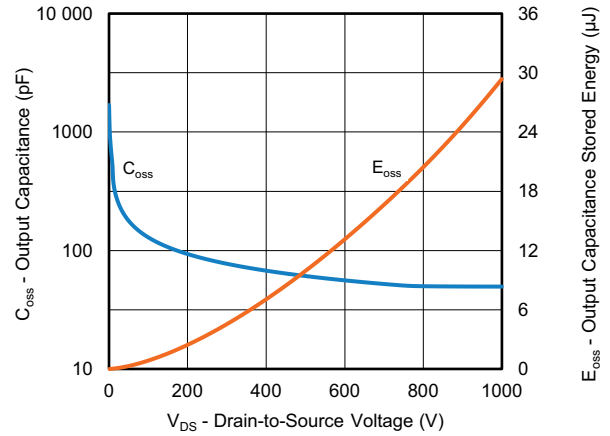
**Fig. 9 - Normalized On-Resistance vs. Temperature**



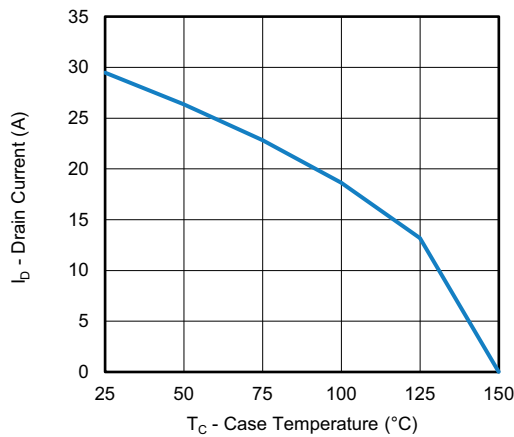
**Fig. 12 - On-Resistance vs. Gate-to-Source Voltage**



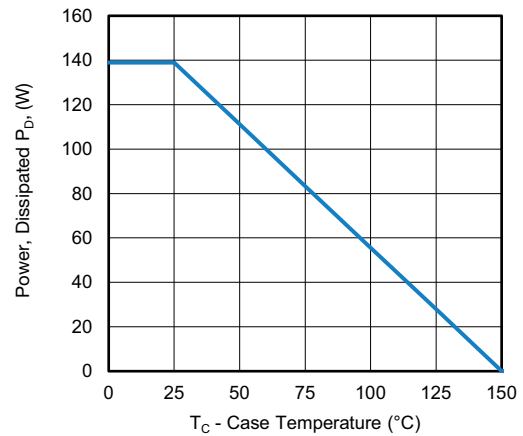
**Fig. 13 - Threshold Voltage vs. Case Temperature**



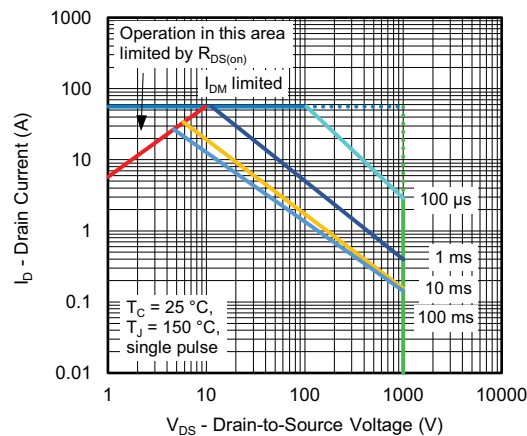
**Fig. 15 - Output Capacitances and its Stored Energy vs. Drain-to-Source Voltage**



**Fig. 14 - Drain Current vs. Case Temperature**



**Fig. 16 - Power, Dissipated P<sub>D</sub> vs. Case Temperature**



**Fig. 17 - Safe Operating Area**

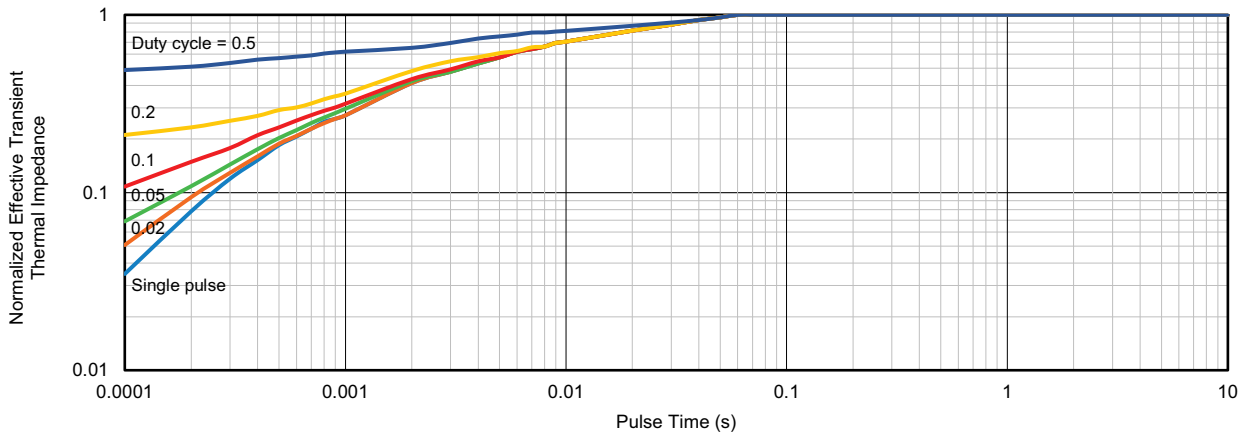
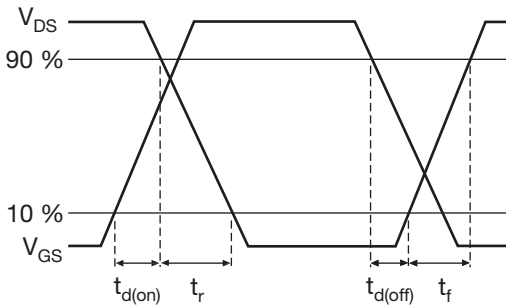
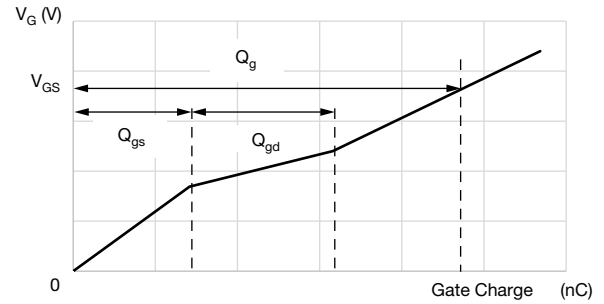
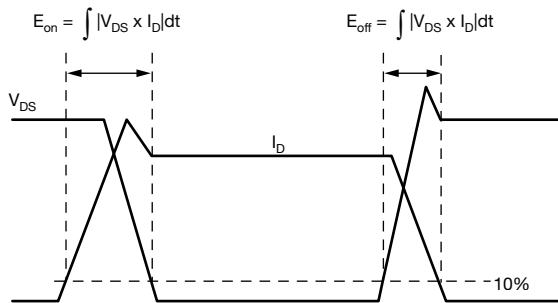
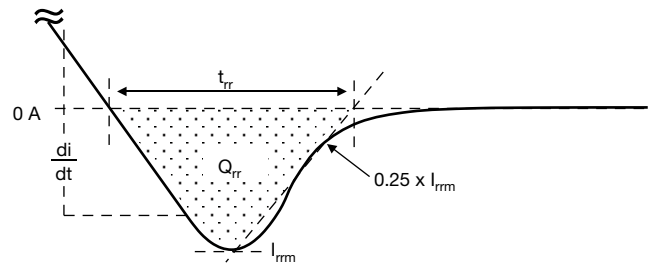
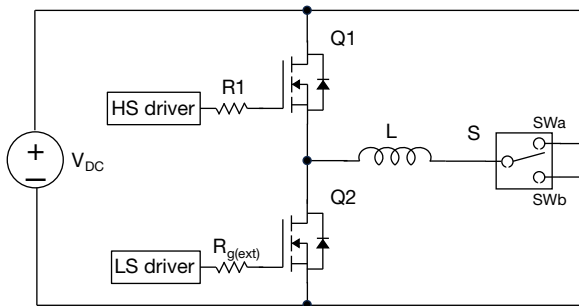


Fig. 18 - Normalized Effective Transient Thermal Impedance

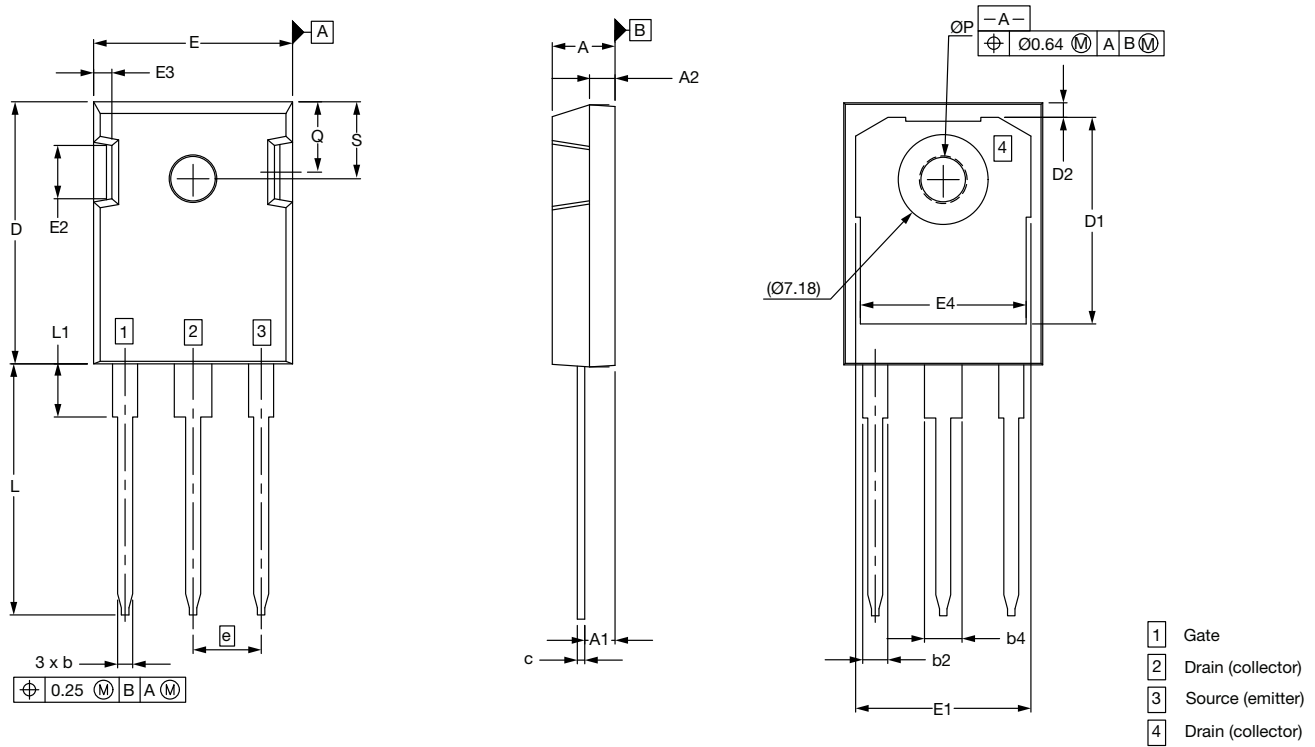

**Fig. 19 - Waveforms of Switching Time**

**Fig. 22 - Waveforms for Gate Charge**

**Fig. 20 - Waveforms for Switching Energy**

**Fig. 23 - Waveforms for Reverse Recovery**

**Fig. 21 - Switching and Reverse Diode Characteristics Measurement Circuit**

Vishay Siliconix maintains worldwide manufacturing capability. Products may be manufactured at one of several qualified locations. Reliability data for Silicon Technology and Package Reliability represent a composite of all qualified locations. For related documents such as package / tape drawings, part marking, and reliability data, see [www.vishay.com/ppg?92811](http://www.vishay.com/ppg?92811).



### Case Outline for TO-247AD 3L

**FACILITY CODE: N**



DIM.	MILLIMETERS	
	MIN.	MAX.
A	4.83	5.21
A1	2.29	2.54
A2	1.91	2.16
b	1.07	1.33
b2	1.91	2.41
b4	2.87	3.38
c	0.55	0.68
D	20.80	21.10
D1	16.25	17.65
D2	0.95	1.25
E	15.75	16.13
E1	13.10	14.15
E2	3.68	5.10
E3	1.00	1.90
E4	12.38	13.43
e	5.44 BSC.	
N	3	
L	19.81	20.32
L1	4.10	4.40
ØP	3.51	3.65
Q	5.49	6.00
S	6.04	6.30

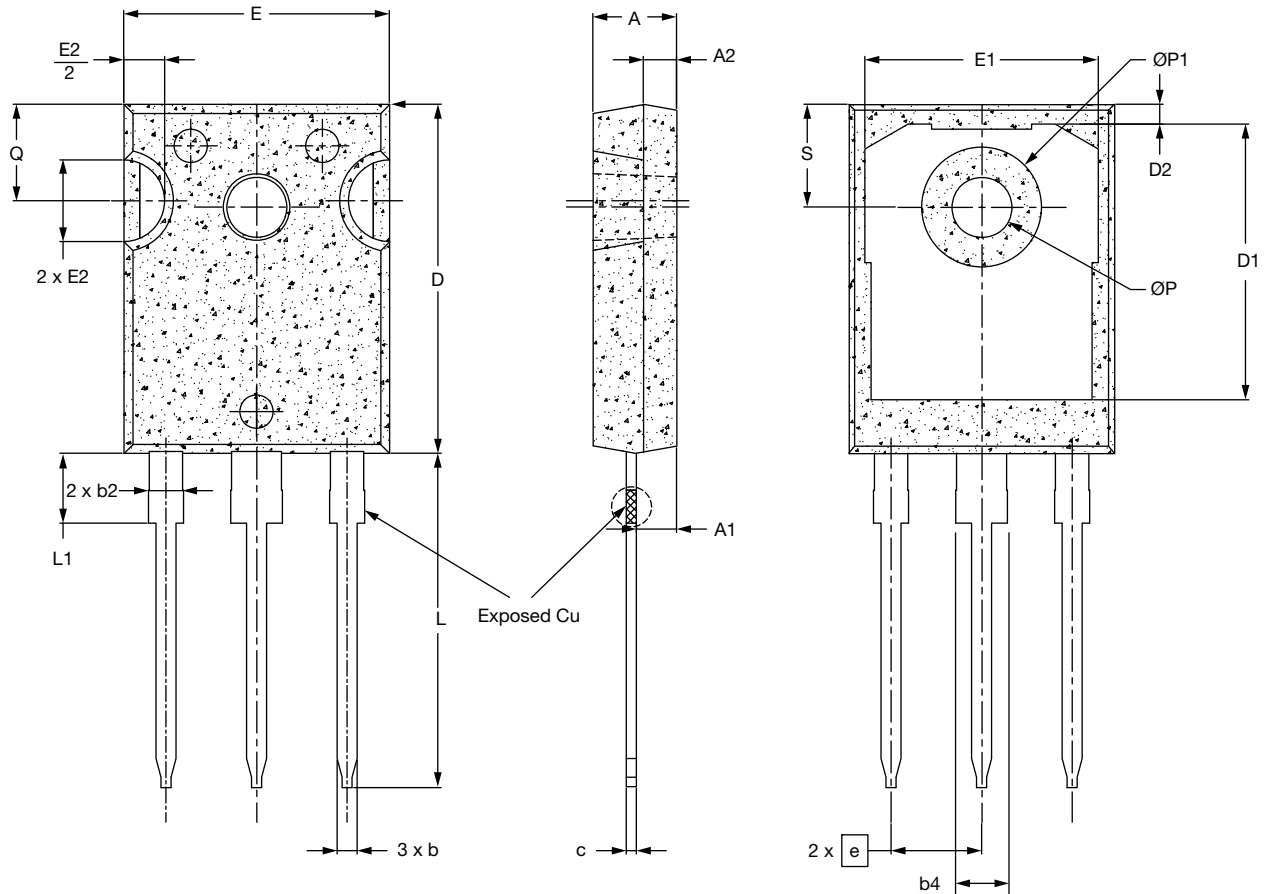
**Notes**

- All metal surfaces: tin plated (MATTE), except area of cut
- Dimensioning and tolerancing confirm to ASME Y14.5M-1994
- All dimensions are in millimeters
- This drawing will meet all dimensions requirement of JEDEC outlines TO-247 AD
- Dimension b2 and b4 does not include dambar protrusion





**FACILITY CODE: 9**





DIM.	MILLIMETERS		
	MIN.	NOM.	MAX.
A	4.83	5.02	5.21
A1	2.29	2.41	2.55
A2	1.50	2.00	2.49
b	1.12	1.20	1.33
b2 <sup>(1)</sup>	1.91	2.00	2.39
b4 <sup>(1)</sup>	2.87	3.00	3.22
c	0.55	0.60	0.69
D <sup>(2)</sup>	20.80	20.95	21.10
D1 <sup>(3)</sup>	16.25	16.55	17.65
D2	0.51	1.19	1.35
E <sup>(2)</sup>	15.75	15.94	16.13
E1 <sup>(3)</sup>	13.46	14.02	14.16
E2	4.32	4.91	5.49
e	5.44 BSC.		
L	19.81	20.07	20.32
L1 <sup>(4)</sup>	4.10	4.19	4.40
ØP <sup>(5)</sup>	3.56	3.61	3.65
ØP1	7.19 ref.		
Q	5.39	5.79	6.20
S	6.04	6.17	6.30
ECN: E24-0303-Rev. B, 19-Aug-2024 DWG: 6118			

### Notes

- Package reference: JEDEC TO-247, variation AD
- All dimensions are in mm
- Slot required, notch may be rounded
- <sup>(1)</sup> Dimension b2 and b4 does not include dambar protrusion
- <sup>(2)</sup> Dimension D and E do not include mold flash
- <sup>(3)</sup> Thermal pad contour optional within dimension D1 and E1
- <sup>(4)</sup> Lead Finish Uncontrolled In L1
- <sup>(5)</sup> ØP to have a draft angle of 1.5 ° ref. to the top of the part with hole diameter of 3.91mm



## Disclaimer

ALL PRODUCT, PRODUCT SPECIFICATIONS AND DATA ARE SUBJECT TO CHANGE WITHOUT NOTICE TO IMPROVE RELIABILITY, FUNCTION OR DESIGN OR OTHERWISE.

Vishay Intertechnology, Inc., its affiliates, agents, and employees, and all persons acting on its or their behalf (collectively, "Vishay"), disclaim any and all liability for any errors, inaccuracies or incompleteness contained in any datasheet or in any other disclosure relating to any product.

Vishay makes no warranty, representation or guarantee regarding the suitability of the products for any particular purpose or the continuing production of any product. To the maximum extent permitted by applicable law, Vishay disclaims (i) any and all liability arising out of the application or use of any product, (ii) any and all liability, including without limitation special, consequential or incidental damages, and (iii) any and all implied warranties, including warranties of fitness for particular purpose, non-infringement and merchantability.

Statements regarding the suitability of products for certain types of applications are based on Vishay's knowledge of typical requirements that are often placed on Vishay products in generic applications. Such statements are not binding statements about the suitability of products for a particular application. It is the customer's responsibility to validate that a particular product with the properties described in the product specification is suitable for use in a particular application. Parameters provided in datasheets and / or specifications may vary in different applications and performance may vary over time. All operating parameters, including typical parameters, must be validated for each customer application by the customer's technical experts. Product specifications do not expand or otherwise modify Vishay's terms and conditions of purchase, including but not limited to the warranty expressed therein.

Hyperlinks included in this datasheet may direct users to third-party websites. These links are provided as a convenience and for informational purposes only. Inclusion of these hyperlinks does not constitute an endorsement or an approval by Vishay of any of the products, services or opinions of the corporation, organization or individual associated with the third-party website. Vishay disclaims any and all liability and bears no responsibility for the accuracy, legality or content of the third-party website or for that of subsequent links.

Vishay products are not designed for use in life-saving or life-sustaining applications or any application in which the failure of the Vishay product could result in personal injury or death unless specifically qualified in writing by Vishay. Customers using or selling Vishay products not expressly indicated for use in such applications do so at their own risk. Please contact authorized Vishay personnel to obtain written terms and conditions regarding products designed for such applications.

No license, express or implied, by estoppel or otherwise, to any intellectual property rights is granted by this document or by any conduct of Vishay. Product names and markings noted herein may be trademarks of their respective owners.