

REVISION	
A	INITIAL DRAWING 02.02.2024

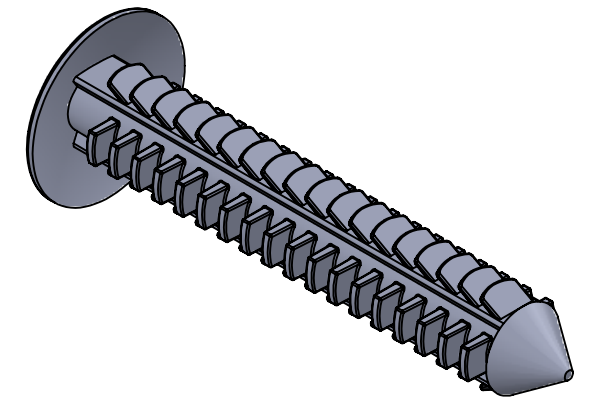

NOTES: DO NOT SCALE DRAWING
MOUNTING HOLE SIZE: Ø6.4
PANEL RANGE: 0.9 to 26.5

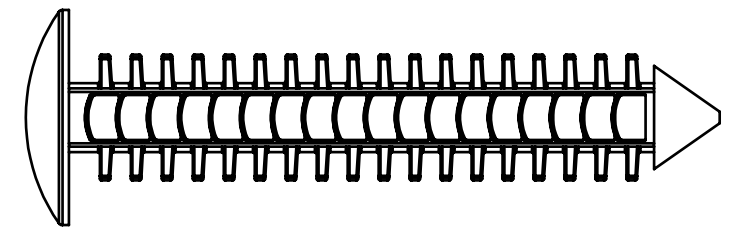
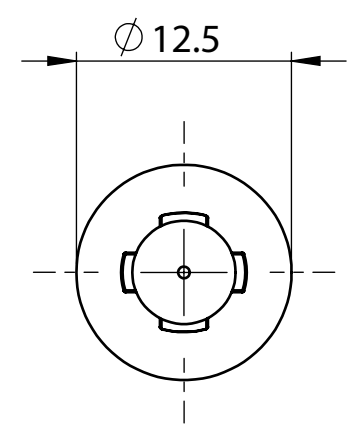
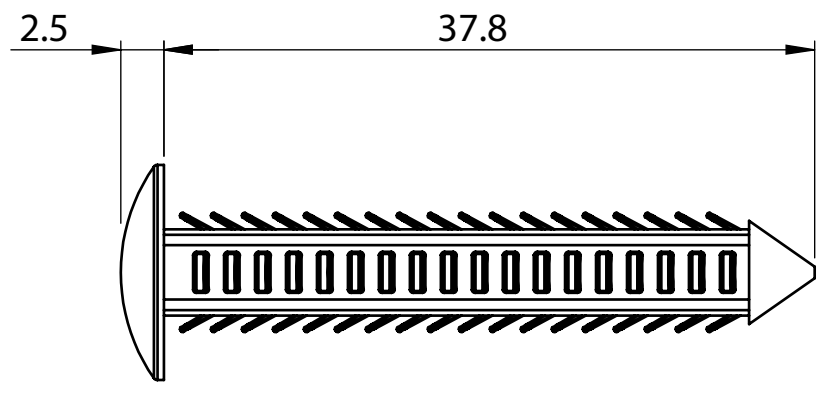

UNLESS OTHERWISE SPECIFIED:
DIMENSIONS ARE IN MM (MILLIMETERS).
TOLERANCES: L<=4: ±0.1
4 < L <=15: ±0.2
15 < L <=50: ±0.3
50 < L <=100: ±0.4

NAME	DATE
DRAWN Andrew Fletcher	08.08.24
CHK'D	
APPVD	

MATERIAL: NYLON 6,6

HEAT TREATMENT: N/A

TITLE: FIR TREE CLIP 6.4mm x 37.8mm

DESIGN RIGHT. TR FASTENINGS LTD, 2024
UNDER NO CIRCUMSTANCES MUST THIS DRAWING BE COPIED
OR DISCLOSED WITHOUT FIRST OBTAINING WRITTEN
AUTHORITY.

CUSTOMER PART NUMBER: N/A

FINISH/COLOUR: BLACK

PART NUMBER: RP0000383425

A4