

Specification

BT45232

BTHQ128064AVD1-FSTF-12-LEDMULTI-COG

Doc. No.: COG-BTD12864-49

Version December 2010

Supplied by:

Midas Displays, Sauls Wharf House, Crittens Road, Great Yarmouth, Norfolk, NR31 0AG.

Telephone: +44 (0)1493 602602

Website: www.midasdisplays.com

Email: sales@midasdisplays.com

Email: tech@midasdisplays.com

DOCUMENT REVISION HISTORY

DOCUMENT REVISION FROM TO	DATE	DESCRIPTION	CHANGED BY	CHECKED BY
A	2010.09.28	First Release. Based on: a.) VL-QUA-012B REV.Y 2010.12.10 According to VL-QUA-012B, LCD size is small because Unit Per Laminate=24 which is more than 6pcs/Laminate.	CHEN YUE	CHI SHAO BO
A B	2010.10.07	Items 1 to 4 were updated: 1.) (Page 6, Figure 2) Block Diagram was updated. 2.) (Page 7,Table 2(a)) Interface signals description was updated. 3.) (Page 11,Table 5) VLCD update define. 4.) (Page 16, Figure 7) Reference circuit was added.	LI WEI	CHI SHAO BO
B C	2010.12.23	Item 1 was updated: 1.) (Page 11,Table 5) None 4 was added.	LI WEI	CHI SHAO BO

Supplied by:

Midas Displays, Sauls Wharf House, Crittens Road, Great Yarmouth, Norfolk, NR31 0AG.

CONTENTS

	<u>Page No.</u>
1. GENERAL DESCRIPTION	4
2. MECHANICAL SPECIFICATIONS	4
3. INTERFACE SIGNALS	7
4. ABSOLUTE MAXIMUM RATINGS	9
4.1 ELECTRICAL MAXIMUM RATINGS – FOR IC ONLY	9
4.2 ENVIRONMENTAL CONDITION	10
5. ELECTRICAL SPECIFICATIONS	11
5.1 TYPICAL ELECTRICAL CHARACTERISTICS	11
5.2 TIMING SPECIFICATIONS	12
5.3 COMMAND TABLE	15
5.4 INITIAL CODE SETTING (FOR REFERENCE ONLY)	16
5.5 REFERENCE CIRCUIT	16
6. ELECTRO-OPTICAL CHARACTERISTICS	17
6.1 ISO PLOT	18
6.2 OPTICAL CHARACTERISTICS DEFINITION	19
7. LCD COSMETIC CONDITIONS	20
8. REMARK	20

Supplied by:

Midas Displays, Sauls Wharf House, Crittens Road, Great Yarmouth, Norfolk, NR31 0AG.

Telephone: +44 (0)1493 602602

Website: www.midasdisplays.com

Email: sales@midasdisplays.com

Email: tech@midasdisplays.com

**Specification
of
LCD Module Type
Model No.: COG-BTD12864-49**

1. General Description

- 128 x 64 Dots FSTN B & W Positive Transflective Dot Matrix LCD Module.
- Viewing Angle: 12 o'clock.
- Driving scheme: 1/65 duty, 1/7 bias.
- 'SITRONIX' ST7565P (COG) LCD controller/ driver or equivalent.
- FPC connection.
- RGB TRI color backlight.
- "RoHS" compliance.

2. Mechanical Specifications

The mechanical detail is shown in Fig. 1 and summarized in Table 1 below.

Table 1

Parameter	Specifications	Unit
Outline dimensions	55.6(W) x 70.2(H) x 4.48(D) (Included FPC. Exclude terminals of backlight)	mm
Viewing area	50.60(W) x 31.0(H)	mm
Active area	46.577(W) x 27.697(H)	mm
Display format	128(W) x 64(H)	dots
Dot size	0.349(W) x 0.418(H)	mm
Dot spacing	0.015(W) x 0.015(H)	mm
Dot pitch	0.364(W) x 0.433(H)	mm
Weight	Approx: 15	grams

Supplied by:

Midas Displays, Sauls Wharf House, Crittens Road, Great Yarmouth, Norfolk, NR31 0AG.

Telephone: +44 (0)1493 602602

Website: www.midasdisplays.com

Email: sales@midasdisplays.com

Email: tech@midasdisplays.com

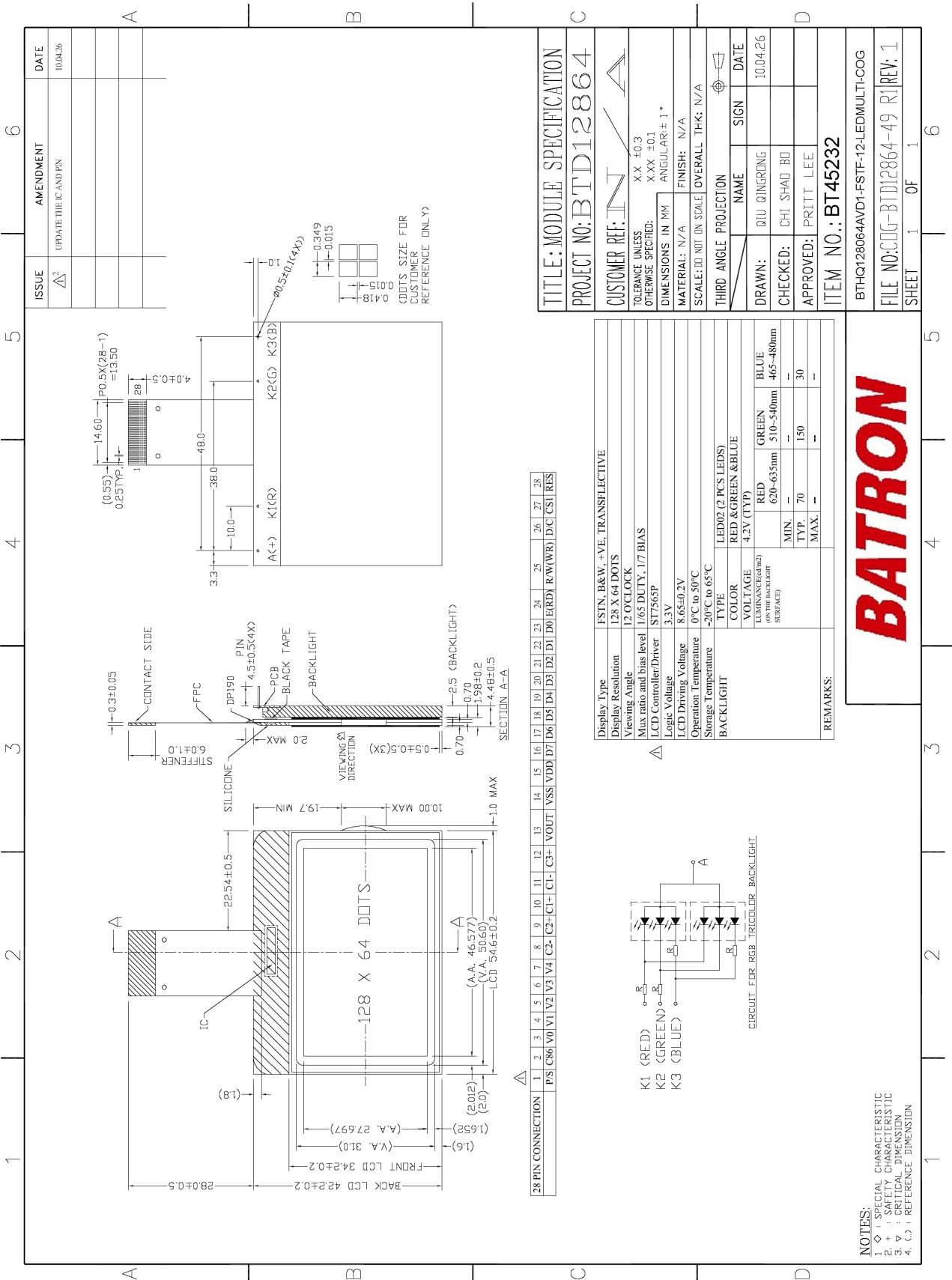

Supplied by: **Figure 1: Module Specification**
 Midas Displays, Sauls Wharf House, Crittens Road, Great Yarmouth, Norfolk, NR31 0AG.

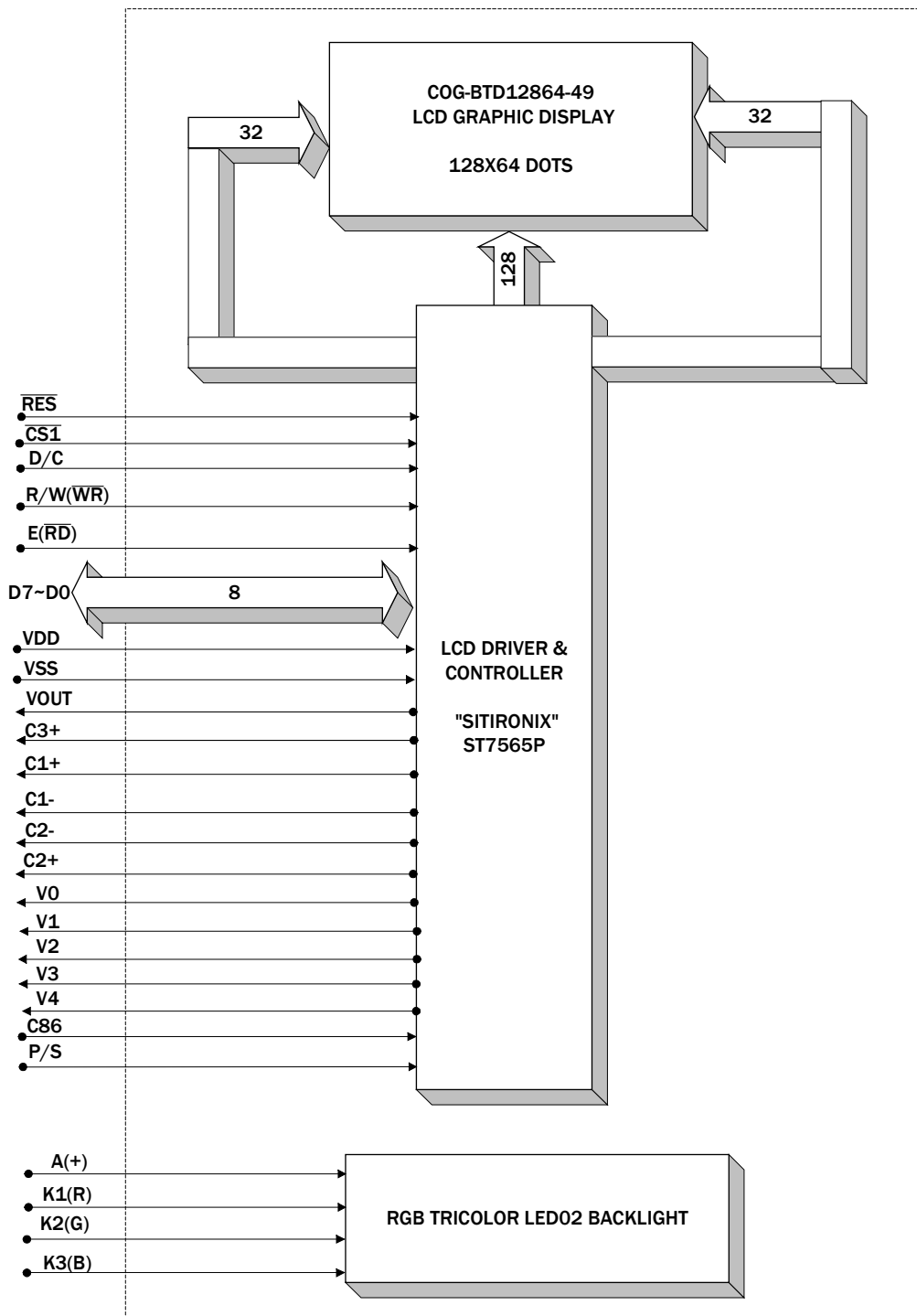

Figure 2: Block Diagram.

Supplied by:

Midas Displays, Sauls Wharf House, Crittens Road, Great Yarmouth, Norfolk, NR31 0AG.

Telephone: +44 (0)1493 602602

Website: www.midasdisplays.com

Email: sales@midasdisplays.com

Email: tech@midasdisplays.com

3. Interface signals

Table 2(a): Pin Assignment

Pin No.	Symbol	Description															
1	P/S	<p>This pin configures the interface to be parallel mode or serial mode.</p> <p>P/S = "H": Parallel data input/output. P/S = "L": Serial data input.</p> <p>The following applies depending on the P/S status:</p> <table border="1"> <thead> <tr> <th>P/S</th> <th>Data/Command</th> <th>Data</th> <th>Read/Write</th> <th>Serial Clock</th> </tr> </thead> <tbody> <tr> <td>"H"</td> <td>D/C</td> <td>D0 to D7</td> <td>\overline{RD}, \overline{WR}</td> <td>X</td> </tr> <tr> <td>"L"</td> <td>D/C</td> <td>D7</td> <td>Write only</td> <td>D6</td> </tr> </tbody> </table> <p>When P/S = "L", D0 to D5 must be fixed to "H".</p> <p>\overline{RD} (E) and \overline{WR} (R/W) are fixed to either "H" or "L". The serial access mode does NOT support read operation.</p>	P/S	Data/Command	Data	Read/Write	Serial Clock	"H"	D/C	D0 to D7	\overline{RD} , \overline{WR}	X	"L"	D/C	D7	Write only	D6
P/S	Data/Command	Data	Read/Write	Serial Clock													
"H"	D/C	D0 to D7	\overline{RD} , \overline{WR}	X													
"L"	D/C	D7	Write only	D6													
2	C86	<p>This is the MPU interface selection pin. C86 = "H": 6800 Series MPU interface. C86 = "L": 8080 Series MPU interface.</p>															
3	V0	<p>This is a multi-level power supply for the liquid crystal drive. The voltage supply applied is determined by the liquid crystal cell, and is changed through the use of a resistive voltage divider or through changing the impedance using an op. amp. Voltage levels are determined based on VSS, and must maintain the relative magnitudes shown below. $V0 \geq V1 \geq V2 \geq V3 \geq V4 \geq VSS$</p> <p>When the power supply turns ON, the internal power supply circuits produce the V1 to V4 voltages shown below. The voltage settings are selected using the LCD bias set command. For 1/7 bias: $V1 = 6/7 * V0$, $V2 = 5/7 * V0$, $V3 = 2/7 * V0$, $V4 = 1/7 * V0$.</p>															
4	V1																
5	V2																
6	V3																
7	V4																
8	C2-	DC/DC voltage converter. Connect a capacitor between this terminal and the CAP2P terminal.															
9	C2+	DC/DC voltage converter. Connect a capacitor between this terminal and the CAP2N terminal.															
10	C1+	DC/DC voltage converter. Connect a capacitor between this terminal and the CAP1N terminal.															
11	C1-	DC/DC voltage converter. Connect a capacitor between this terminal and the CAP1P terminal.															
12	C3+	DC/DC voltage converter. Connect a capacitor between this terminal and the CAP1N terminal.															
13	VOOUT	DC/DC voltage converter. Connect a capacitor between this terminal and VSS or VDD.															
14	VSS	Ground.															
15	VDD	Power supply pins for logic.															

Supplied by:

Midas Displays, Sauls Wharf House, Crittens Road, Great Yarmouth, Norfolk, NR31 0AG.

Table 2(b): Pin Assignment

Pin No.	Symbol	Description
16	D7	<p>This is an 8-bit bi-directional data bus that connects to an 8-bit standard MPU data bus.</p> <p>When the serial interface is selected (P/S = LOW), then D7 serves as the serial data input terminal (SI) and D6 serves as the serial clock input terminal (SCL). At this time, D0 to D5 are set to high impedance.</p> <p>When the chip select is inactive, D0 to D7 are set to high impedance.</p>
17	D6	
18	D5	
19	D4	
20	D3	
21	D2	
22	D1	
23	D0	
24	$E(\overline{RD})$	<p>When connected to 8080 series MPU, this pin is treated as the "\overline{RD}" signal of the 8080 MPU and is LOW-active.</p> <p>The data bus is in an output status when this signal is "L".</p> <p>When connected to 6800 series MPU, this pin is treated as the "E" signal of the 6800 MPU and is HIGH-active.</p> <p>This is the enable clock input terminal of the 6800 Series MPU.</p>
25	R/W(\overline{WR})	<p>When connected to 8080 series MPU, this pin is treated as the "\overline{WR}" signal of the 8080 MPU and is LOW-active.</p> <p>The signals on the data bus are latched at the rising edge of the \overline{WR} signal.</p> <p>When connected to 6800 series MPU, this pin is treated as the "R/W" signal of the 6800 MPU and decides the access type :</p> <p>When R/W = "H": Read.</p> <p>When R/W = "L": Write.</p>
26	D/C	<p>This is connect to the least significant bit of the normal MPU address bus, and it determines whether the data bits are data or command.</p> <p>D/C = "H": Indicates that D0 to D7 are display data.</p> <p>D/C= "L": Indicates that D0 to D7 are control data.</p>
27	$\overline{CS1}$	<p>This is the chip select signal. When $\overline{CS1}$ = "L", then the chip select becomes active, and data/command I/O is enabled.</p>
28	\overline{RES}	<p>When \overline{RES} is set to "L", the register settings are initialized (cleared).</p> <p>The reset operation is performed by the /RES signal level.</p>

Supplied by:

Midas Displays, Sauls Wharf House, Crittens Road, Great Yarmouth, Norfolk, NR31 0AG.

Telephone: +44 (0)1493 602602

Website: www.midasdisplays.com

Email: sales@midasdisplays.com

Email: tech@midasdisplays.com

4. Absolute Maximum Ratings

4.1 Electrical Maximum Ratings – for IC Only

Table 3

Parameter	Symbol	Min.	Max.	Unit
Power Supply voltage (Logic)	VDD	+0.3	+3.6	V
Power Supply voltage (VDD2)	VDD2	+0.3	+3.6	V
Power Supply voltage (V0, VOUT)	V0, VOUT	+0.3	+14.5	V
Power Supply voltage (V1, V2, V3, V4)	V1, V2, V3, V4	V0	+0.3	V

Note:

1. The VDD2, V0 to V4 and VOUT are relative to the VSS = 0V reference.
2. Insure that the voltage levels of V1, V2, V3, and V4 are always such that $VOUT \geq V0 \geq V1 \geq V2 \geq V3 \geq V4$.
3. Permanent damage to the LSI may result if the LSI is used outside of the absolute maximum ratings. Moreover, it is recommended that in normal operation the chip be used at the electrical characteristic conditions, and use of the LSI outside of these conditions may not only result in malfunctions of the LSI, but may have a negative impact on the LSI reliability as well.

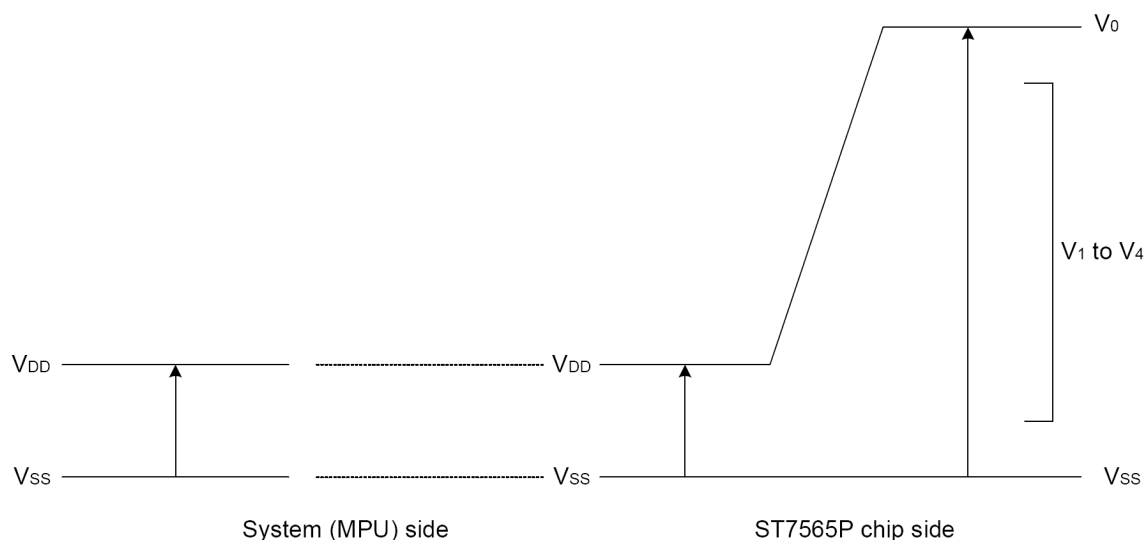

Figure 3

Supplied by:

Midas Displays, Sauls Wharf House, Crittens Road, Great Yarmouth, Norfolk, NR31 0AG.

4.2 Environmental Condition

Table 4

Item	Operating Temperature (Topr)		Storage Temperature (Tstg) (Note 1)		Remark
	Min.	Max.	Min.	Max.	
Ambient Temperature	0°C	+50°C	-20°C	+65°C	Dry
Humidity (Note 1)	90% max. RH for $T_a \leq 40^\circ\text{C}$ < 50% RH for $40^\circ\text{C} < T_a \leq$ Maximum operating temperature				No condensation
Vibration (IEC 68-2-6) cells must be mounted on a suitable connector	Frequency: 10 ~ 55 Hz Amplitude: 0.75 mm Duration: 20 cycles in each direction.				3 directions
Shock (IEC 68-2-27) Half-sine pulse shape	Pulse duration: 11 ms Peak acceleration: $981 \text{ m/s}^2 = 100\text{g}$ Number of shocks: 3 shocks in 3 mutually perpendicular axes.				3 directions

Note 1: Product cannot sustain at extreme storage conditions for long time.

Supplied by:

Midas Displays, Sauls Wharf House, Crittens Road, Great Yarmouth, Norfolk, NR31 0AG.

5. Electrical Specifications

5.1 Typical Electrical Characteristics

At Ta = +25 °C, VDD = +3.3±5%, VSS = 0V.

Table 5

Parameter	Symbol	Conditions	Min.	Typ.	Max.	Unit
Supply voltage (Logic)	VDD-VSS		3.14	3.3	3.47	V
Supply voltage (LCD) (built-in)	VLCD =V0-VSS	Ta = 0 °C, Character mode VDD = +3.3V, Note 1	-	8.9	-	V
		Ta = 25 °C, Character mode VDD = +3.3V, Note 1	8.45	8.65	8.85	V
		Ta = +50 °C, Character mode VDD = +3.3V, Note 1	-	8.1	-	V
Low-level input signal voltage	V _{ILC}	Note 2	VSS	-	0.2xVDD	V
High-level input signal voltage	V _{IHC}	Note 2	0.8xVDD	-	VDD	V
Supply Current (Logic & LCD)	IDD	VDD = +3.3V, Note 1, Character mode	-	0.46	0.69	mA
		VDD = +3.3V, Note 1, Checker board mode	-	0.78	1.2	mA
Supply current of LED02 backlight	VLED (RED)	Forward voltage = 4.2V	-	30	40	mA
	(GREEN) VLED		-	30	40	
	(BLUE) VLED		-	30	40	
Wavelength of LED02 backlight	λ (RED)	Number of LED die =2dies.	620	628	635	nm
	λ (GREEN)		510	525	540	
	λ (BLUE)		465	472	480	
Luminance (on the backlight surface) of backlight	(RED)	Note 4	38	70	140	cd/m ²
	(GREEN)		80	150	280	
	(BLUE)		15	30	80	

Note 1: There is tolerance in optimum LCD driving voltage during production and it will be within the specified range.

Note 2: D/C, D0 to D5, D6, D7, E(RD),R/W(WR),CS1,C86,P/S,RES terminals.

Note 3: Do not display a fixed pattern for more than 30 min. because it may cause image sticking due to LCD characteristics. It is recommended to change display pattern frequently. If customer must fix display pattern on the screen, please consider to activate screen saver.

Note 4: The expected lifetime of backlight is 15K hours at 25°C,RH45%, If=15mA/die. This is a presumption target, no experimental data support.

Supplied by:

Midas Displays, Sauls Wharf House, Crittens Road, Great Yarmouth, Norfolk, NR31 0AG.

5.2 Timing Specifications

System Bus read/Write Characteristics 1 (For the 8080 Series MPU)

At $T_a = 0\text{ }^{\circ}\text{C}$ to $+50\text{ }^{\circ}\text{C}$, $V_{DD} = +3.3\text{V} \pm 5\%$, $V_{SS} = 0\text{V}$.

Table 6

Item	Signal	Symbol	Condition	Rating		Units
				Min.	Max.	
Address hold time	A0	t _{AH8}		0	—	Ns
Address setup time		t _{AW8}		0	—	
System cycle time		t _{CYC8}		240	—	
Enable L pulse width (WRITE)	WR	t _{CCLW}		80	—	
Enable H pulse width (WRITE)		t _{CCHW}		80	—	
Enable L pulse width (READ)	RD	t _{CCLR}		140	—	
Enable H pulse width (READ)		t _{CCHR}		80	—	
WRITE Data setup time	D0 to D7	t _{DS8}		40	—	
WRITE Address hold time		t _{DH8}		0	—	
READ access time		t _{ACC8}	CL = 100 pF	—	70	
READ Output disable time		t _{OH8}	CL = 100 pF	5	50	

*1 The input signal rise time and fall time (t_r , t_f) is specified at 15 ns or less. When the system cycle time is extremely fast, $(t_r + t_f) \leq (t_{CYC8} - t_{CCLW} - t_{CCHW})$ for $(t_r + t_f) \leq (t_{CYC8} - t_{CCLR} - t_{CCHR})$ are specified.

*2 All timing is specified using 20% and 80% of V_{DD} as the reference.

*3 t_{CCLW} and t_{CCLR} are specified as the overlap between $\overline{CS1}$ being "L" ($CS2 = \text{"H"}$) and \overline{WR} and \overline{RD} being at the "L" level.

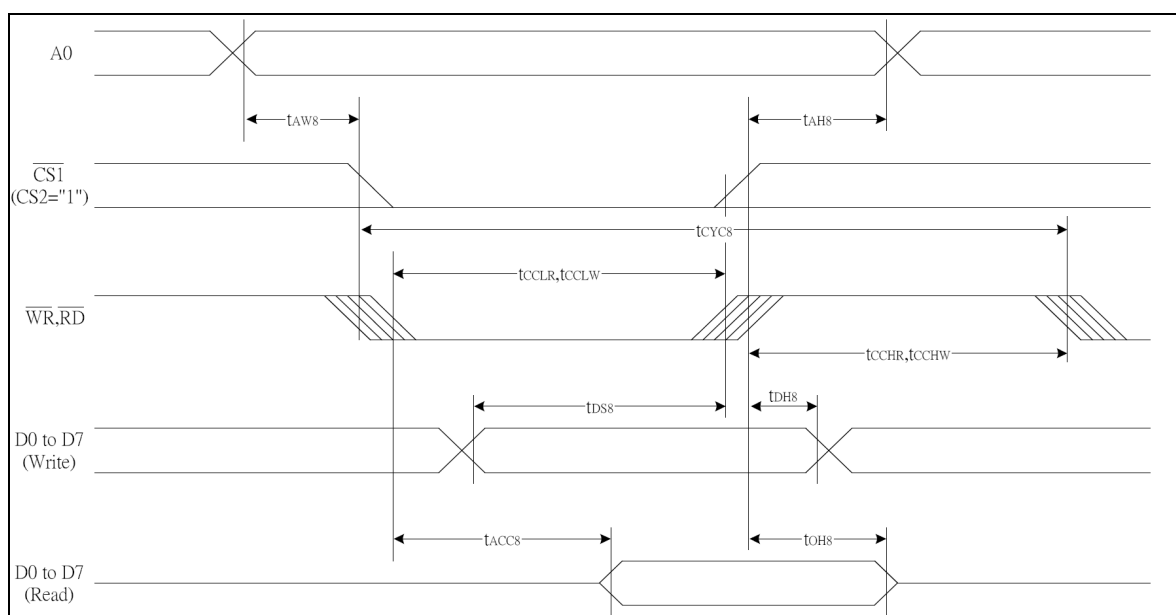

Figure 4: The timing diagram of system bus read/write (For the 8080 Series MPU)

Supplied by:

Midas Displays, Sauls Wharf House, Crittens Road, Great Yarmouth, Norfolk, NR31 0AG.

System Bus read/Write Characteristics 2 (For the 6800 Series MPU)

At $T_a = 0\text{ }^\circ\text{C}$ to $+50\text{ }^\circ\text{C}$, $V_{DD} = +3.3\text{V} \pm 5\%$, $V_{SS} = 0\text{V}$.

Table 7

Item	Signal	Symbol	Condition	Rating		Units
				Min.	Max.	
Address hold time	A0	t_{AH6}		0	—	ns
Address setup time		t_{AW6}		0	—	
System cycle time		t_{CYC6}		240	—	
Enable L pulse width (WRITE)	WR	t_{EWLW}		80	—	
Enable H pulse width (WRITE)		t_{EWHW}		80	—	
Enable L pulse width (READ)	RD	t_{EWLR}		80	—	
Enable H pulse width (READ)		t_{EWHR}		140	—	
WRITE Data setup time	D0 to D7	t_{DS6}		40	—	
WRITE Address hold time		t_{DH6}		0	—	
READ access time		t_{ACC6}	$CL = 100\text{ pF}$	—	70	
READ Output disable time		t_{OH6}	$CL = 100\text{ pF}$	5	50	

*1 The input signal rise time and fall time (t_r , t_f) is specified at 15 ns or less. When the system cycle time is extremely fast, $(t_r + t_f) \leq (t_{CYC6} - t_{EWLW} - t_{EWHW})$ for $(t_r + t_f) \leq (t_{CYC6} - t_{EWLR} - t_{EWHR})$ are specified.

*2 All timing is specified using 20% and 80% of V_{DD} as the reference.

*3 t_{EWLW} and t_{EWLR} are specified as the overlap between $\overline{CS1}$ being "L" ($CS2 = "H"$) and E.

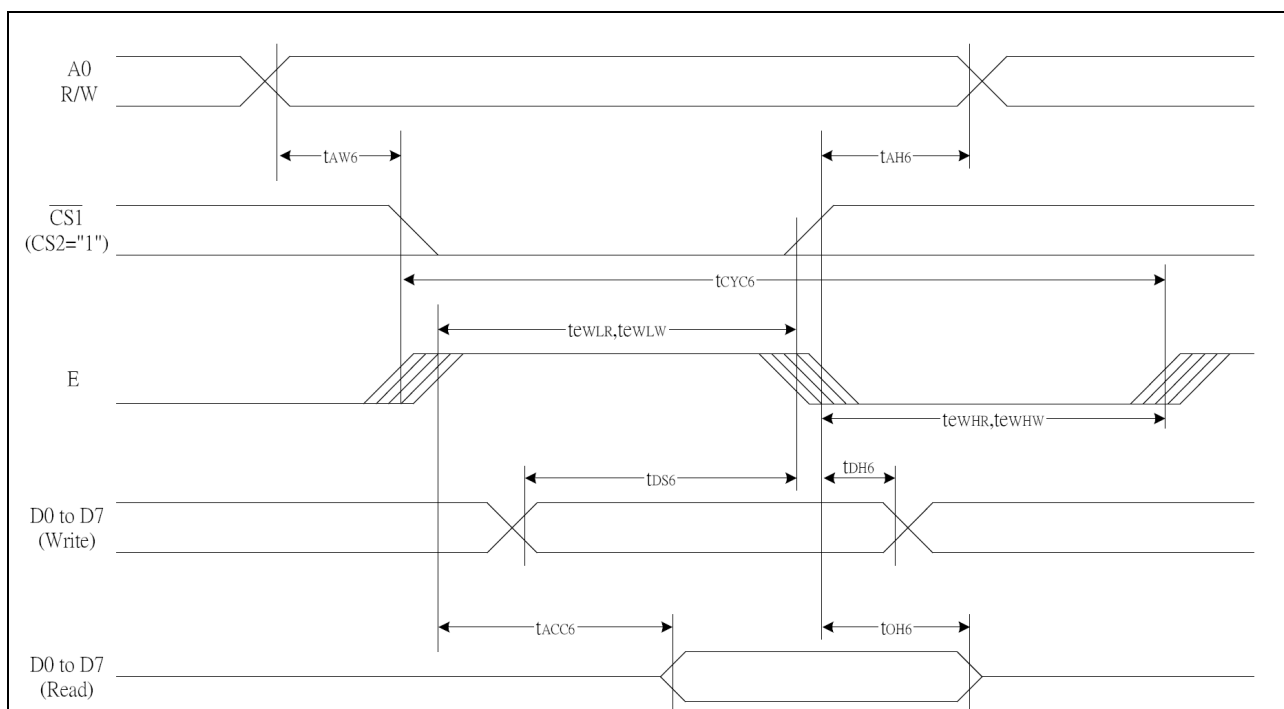

Figure 5: The timing diagram of system bus read/write (For the 6800 Series MPU)

Supplied by:

Midas Displays, Sauls Wharf House, Crittens Road, Great Yarmouth, Norfolk, NR31 0AG.

Reset Timing

At Ta = 0 °C to +50 °C, VDD = +3.3V±5%, VSS = 0V.

Table 8

Item	Signal	Symbol	Condition	Rating			Units
				Min.	Typ.	Max.	
Reset time		t _R		—	—	1.0	us
Reset "L" pulse width	/RES	t _{RW}		1.0	—	—	us

*1 All timing is specified with 20% and 80% of VDD as the standard.

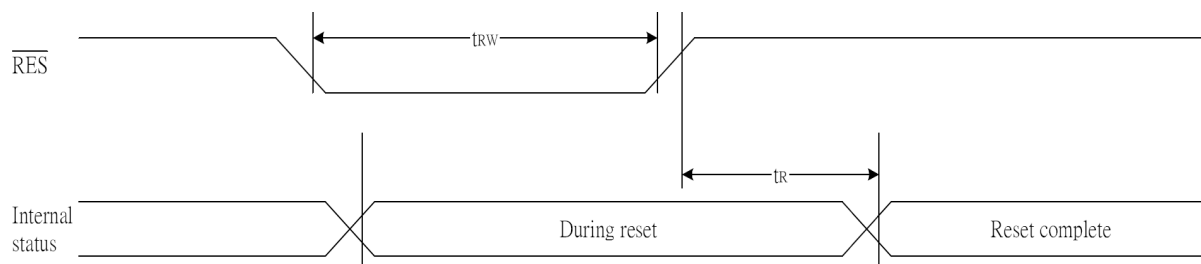

Figure 6: Reset Timing

Supplied by:

Midas Displays, Sauls Wharf House, Crittens Road, Great Yarmouth, Norfolk, NR31 0AG.

Telephone: +44 (0)1493 602602

Website: www.midasdisplays.com

Email: sales@midasdisplays.com

Email: tech@midasdisplays.com

5.3. Command Table

Table 9

Command	Command Code									Function			
	A0	/RD	/WR	D7	D6	D5	D4	D3	D2		D1	D0	
(1) Display ON/OFF	0	1	0	1	0	1	0	1	1	1	0	1	LCD display ON/OFF 0: OFF, 1: ON
(2) Display start line set	0	1	0	0	1	Display start address					0	Sets the display RAM display start line address	
(3) Page address set	0	1	0	1	0	1	1	Page address				0	Sets the display RAM page address
(4) Column address set upper bit	0	1	0	0	0	0	1	Most significant column address				0	Sets the most significant 4 bits of the display RAM column address. Sets the least significant 4 bits of the display RAM column address.
Column address set lower bit	0	1	0	0	0	0	0	Least significant column address				0	
(5) Status read	0	0	1	Status				0	0	0	0	0	Reads the status data
(6) Display data write	1	1	0	Write data							0	Writes to the display RAM	
(7) Display data read	1	0	1	Read data							0	Reads from the display RAM	
(8) ADC select	0	1	0	1	0	1	0	0	0	0	0	0	Sets the display RAM address SEG output correspondence 0: normal, 1: reverse
(9) Display normal/reverse	0	1	0	1	0	1	0	0	1	1	0	1	Sets the LCD display normal/reverse 0: normal, 1: reverse
(10) Display all points ON/OFF	0	1	0	1	0	1	0	0	1	0	0	1	Display all points 0: normal display 1: all points ON
(11) LCD bias set	0	1	0	1	0	1	0	0	0	1	0	1	Sets the LCD drive voltage bias ratio 0: 1/9 bias, 1: 1/7 bias (ST7565P)
(12) Read/modify/write	0	1	0	1	1	1	0	0	0	0	0	0	Column address increment At write: +1 At read: 0
(13) End	0	1	0	1	1	1	0	1	1	1	0	0	Clear read/modify/write
(14) Reset	0	1	0	1	1	1	0	0	0	1	0	0	Internal reset
(15) Common output mode select	0	1	0	1	1	0	0	0	1	*	*	*	Select COM output scan direction 0: normal direction 1: reverse direction
(16) Power control set	0	1	0	0	0	1	0	1	Operating mode			0	Select internal power supply operating mode
(17) V0 voltage regulator internal resistor ratio set	0	1	0	0	0	1	0	0	Resistor ratio			0	Select internal resistor ratio(Rb/Ra) mode
(18) Electronic volume mode set	0	1	0	1	0	0	0	0	0	0	0	1	Set the V0 output voltage electronic volume register
Electronic volume register set				0	0	Electronic volume value					0		
(19) Static indicator ON/OFF	0	1	0	1	0	1	0	1	1	0	0	0	0: OFF, 1: ON
Static indicator register set				0	0	0	0	0	0	0	0	0	Mode
(20) Booster ratio set	0	1	0	1	1	1	1	1	0	0	0	0	select booster ratio 00: 2x,3x,4x 01: 5x 11: 6x
(21) Power saver													Display OFF and display all points ON compound command
(22) NOP	0	1	0	1	1	1	0	0	0	1	1	1	Command for non-operation
(23) Test	0	1	0	1	1	1	1	*	*	*	*	*	Command for IC test. Do not use this command

Supplied by:

Midas Displays, Sauls Wharf House, Crittens Road, Great Yarmouth, Norfolk, NR31 0AG.

5.4 Initial code setting (for reference only)

Table 10

Description	Setting data
Reset	0xe2
LCD bias set	0xa3
ADC select	0xa0
Common output mode select	0xc8
V5 voltage regulator internal resistor ratio set	0x25
Electronic volume mode set	0x81
Electronic volume	0x13
Power control set	0x25
Display start line set	0x40
Page address set	0xb0
Column address upper bit set	0x10
Column address lower bit set	0x04
Display all point ON/OFF	0xa4
Display normal or reverse	0xa6

5.5 Reference circuit

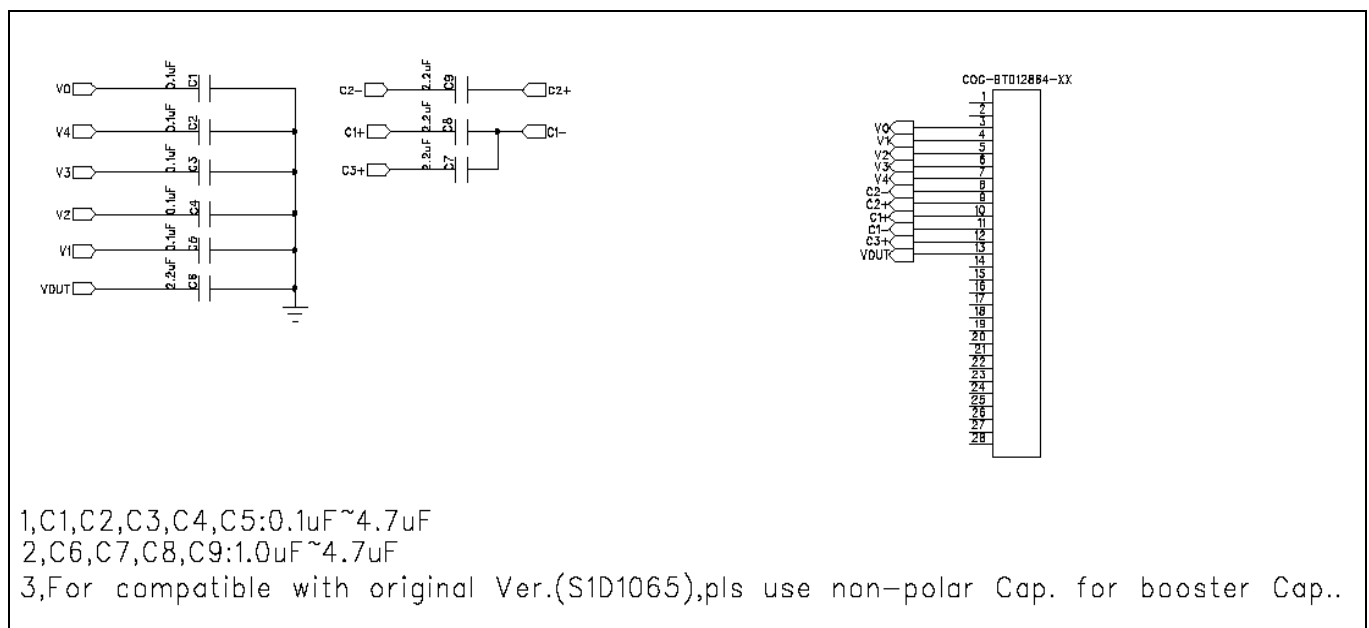

Figure 7: Reference Circuit Diagram

Supplied by:

Midas Displays, Sauls Wharf House, Crittens Road, Great Yarmouth, Norfolk, NR31 0AG.

6. Electro-Optical Characteristics

Table 11(B/L: Red)

Item	Symbol	Temp. °C	Value			Unit	Condition	
			Min.	Typ.	Max.			
Driving voltage	Vop	+25	-	8.75	-	V	Vop= optimum voltage	
Response time	Ton	+25	-	4119	4942	msec	Vop= Optimum voltage $\theta = 0^\circ, \phi = 0^\circ$	
	Toff		-	7087	9213			
Optimum viewing area Cr ≥ 2	$\theta 1(6 \text{ o'clock})$	+25	22	32	-	DEG	$\phi = 0^\circ$	Vop= Optimum voltage (Remark 1)
	$\theta 2(12 \text{ o'clock})$		15	22	-			
	$\phi 1(3 \text{ o'clock})$		14	20	-		$\theta = 0^\circ$	
	$\phi 2(9 \text{ o'clock})$		17	25	-			
Contrast ratio	Cr	+25	2.8	4	-	Vop = Optimum voltage $\theta = 0^\circ, \phi = 0^\circ$		
Transmittance		+25	14%	20%	-	-	Vop = Optimum voltage	

Remark 1: Due to hardware limitation, the maximum measurable angle is 50°

Table 12(B/L: Green)

Item	Symbol	Temp. °C	Value			Unit	Condition	
			Min.	Typ.	Max.			
Driving voltage	Vop	+25	-	8.76	-	V	Vop= optimum voltage	
Response time	Ton	+25	-	5136	6677	msec	Vop= Optimum voltage $\theta = 0^\circ, \phi = 0^\circ$	
	Toff		-	4231	5500			
Optimum viewing area Cr ≥ 2	$\theta 1(6 \text{ o'clock})$	+25	21	30	-	DEG	$\phi = 0^\circ$	Vop= Optimum voltage (Remark 1)
	$\theta 2(12 \text{ o'clock})$		22	35	-			
	$\phi 1(3 \text{ o'clock})$		30	43	-		$\theta = 0^\circ$	
	$\phi 2(9 \text{ o'clock})$		20	28	-			
Contrast ratio	Cr	+25	2.8	4	-	Vop = Optimum voltage $\theta = 0^\circ, \phi = 0^\circ$		
Transmittance		+25	13%	19%	-	-	Vop = Optimum voltage	

Remark 1: Due to hardware limitation, the maximum measurable angle is 50°

Supplied by:

Midas Displays, Sauls Wharf House, Crittens Road, Great Yarmouth, Norfolk, NR31 0AG.

Telephone: +44 (0)1493 602602

Website: www.midasdisplays.com

Email: sales@midasdisplays.com

Email: tech@midasdisplays.com

Table 13(B/L: Blue)

Item	Symbol	Temp. °C	Value			Unit	Condition	
			Min.	Typ.	Max.			
Driving voltage	Vop	+25	-	8.75	-	V	Vop= optimum voltage	
Response time	Ton	+25	-	8487	11033	msec	Vop= Optimum voltage $\theta = 0^\circ, \phi = 0^\circ$	
	Toff		-	7314	9508			
Optimum viewing area Cr ≥ 2	$\theta 1$ (6 o'clock)	+25	21	30	-	DEG	$\phi = 0^\circ$	Vop= Optimum voltage (Remark 1)
	$\theta 2$ (12 o'clock)		28	40	-			
	$\phi 1$ (3 o'clock)		28	40	-		$\theta = 0^\circ$	
	$\phi 2$ (9 o'clock)		20	28	-			
Contrast ratio	Cr	+25	2.8	4	-	Vop = Optimum voltage $\theta = 0^\circ, \phi = 0^\circ$		
Transmittance		+25	12%	17%	-	Vop = Optimum voltage		

Remark 1: Due to hardware limitation, the maximum measurable angle is 50°

6.1 ISO plot

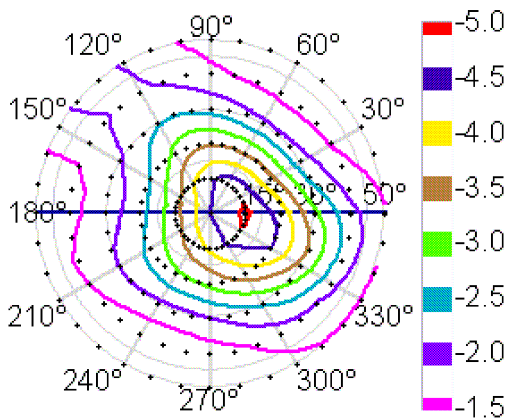

Figure 7: B/L: Red

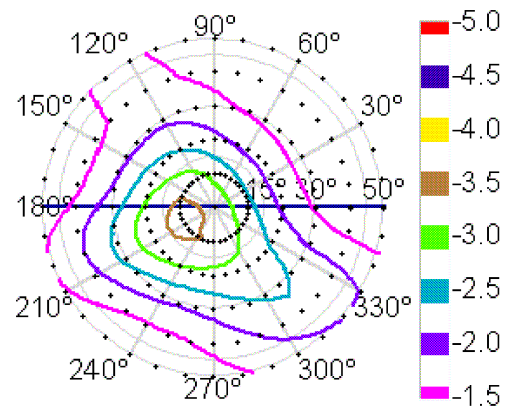

Figure 8: B/L: Green

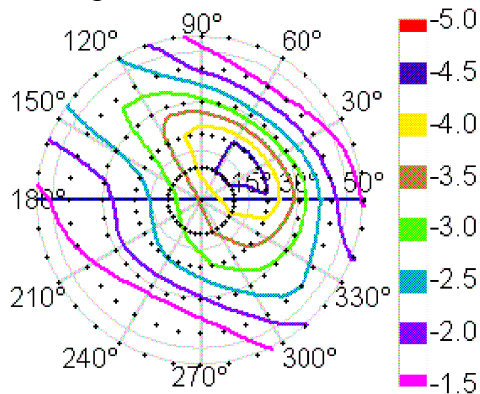

Figure 9: B/L: Blue

Supplied by:

Midas Displays, Sauls Wharf House, Crittens Road, Great Yarmouth, Norfolk, NR31 0AG.

6.2 Optical Characteristics Definition

a.) Viewing Angle

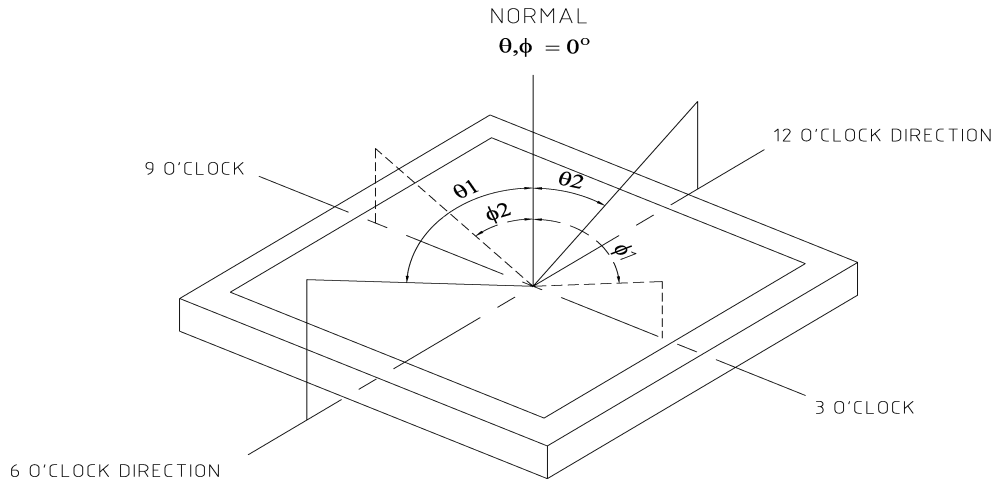

b.) Contrast Ratio

B1 = segments luminance in case of non-selected waveform

B2 = segments luminance in case of selected waveform

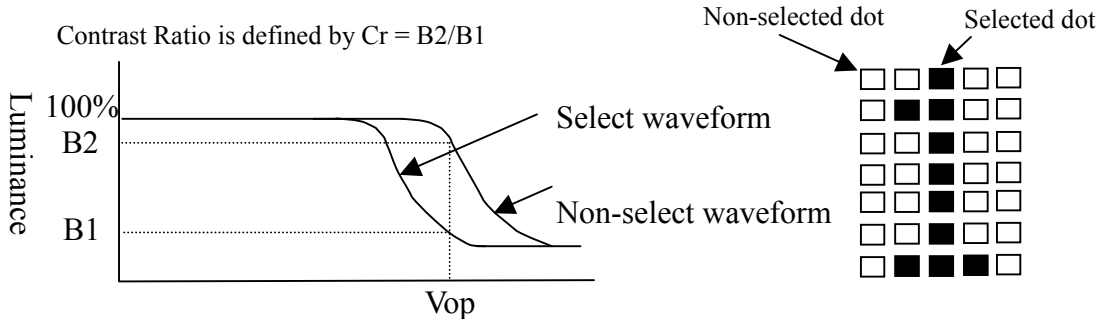

c.) Response Time

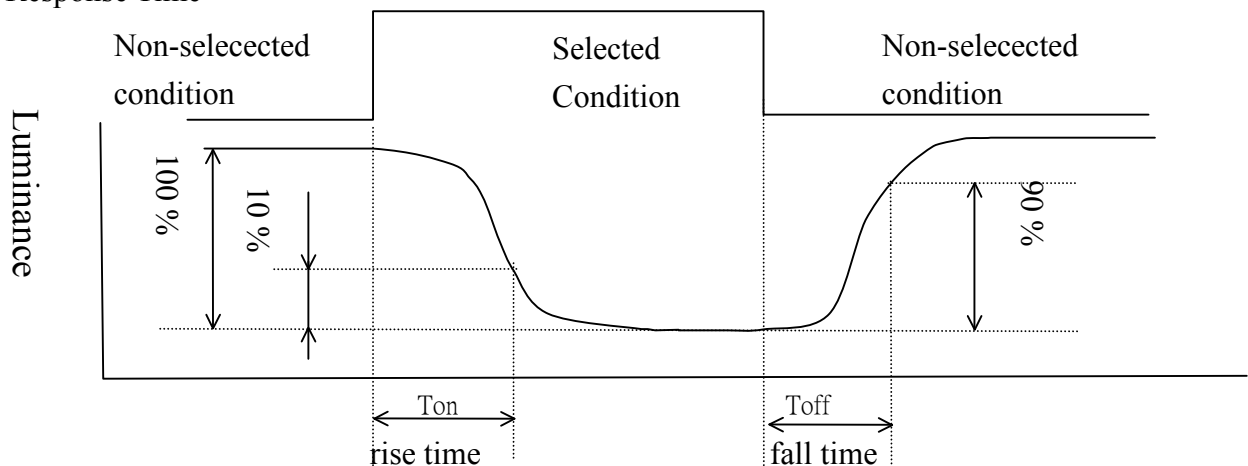

Supplied by:

Midas Displays, Sauls Wharf House, Crittens Road, Great Yarmouth, Norfolk, NR31 0AG.