

# TRI BAND WI-FI 6E/7 PCB ANTENNA



**AANI-FB-0083**

Request Samples



Check Inventory



**41 x 9 x 0.7 mm**  
**RoHS Compliant**  
MSL Level = N/A

## Features

- Compact Design with High Efficiency Up to 90%
- Easy Installation on Flat Surfaces
- Can be Installed on Plastic and Human Body
- Strong Adhesive in High-Temperature and Humid Environment
- Fully Customizable Cable Length and Connector Options
- RoHS Compliant

## Applications

- WiFi/WLAN coverage
  - WiFi 7 (802.11be)
  - WiFi 6/6E (802.11ax)
  - WiFi 4/5 (802.11b/g/n/ac)
- Bluetooth® / ZigBee® / Thread/ Matter
- Router and Networking
- Home Automation and Remote Sensing

## Product Image



# TRI BAND WI-FI 6E/7 PCB ANTENNA



AANI-FB-0083

Request Samples



Check Inventory



41 x 9 x 0.7 mm  
RoHS Compliant  
MSL Level = N/A

## Electrical Specification

Parameter	Specification			Unit
Operating Frequency	2400 – 2483.5	5150 - 5850	5925 - 7125	MHz
VSWR (Typ.)	< 2.5			
Peak gain	2.6	3.9	4.2	dBi
Efficiency (Avg.)	91.5	87.3	72.1	%
Impedance	50			$\Omega$
Polarization	Linear			
Radiation Pattern	Omni-directional			

## Mechanical Specification

Parameter	Specification
Antenna Dimensions	41 x 9 x 0.7 mm
Antenna Type	Flexible Printed Circuit
Mounting Type	Adhesive
RF Connector <sup>(1)</sup>	u.FL/IPEX-1/MHF1, w.FL/IPEX-4/MHF4
RF Cable Type <sup>(1)</sup>	$\varnothing$ 1.13 mm
Cable Length <sup>(1)</sup>	50 mm, 100 mm, 150 mm, 200 mm, 250 mm, 300 mm

(1): Fully customizable RF Cable & Connector

## Environmental Specification

Parameter	Specification
Operating Temperature	-40°C to +85°C
Storage Temperature	-40°C to +85°C
RoHS Complaint	Yes
PB Free	Yes



5101 Hidden Creek Ln Spicewood TX 78669  
Phone: 512-371-6159 | Fax: 512-351-8858  
For terms and conditions of sales, please visit:  
[www.abracon.com](http://www.abracon.com)

REVISED: 08-12-24

ABRACON IS  
ISO9001-2015  
CERTIFIED

# TRI BAND WI-FI 6E/7 PCB ANTENNA



**AANI-FB-0083**

Request Samples



Check Inventory



41 x 9 x 0.7 mm  
**RoHS Compliant**  
 MSL Level = N/A

## Ordering Information

Part Number	Description	Connector Option
AANI-FB-0083-0050I	TRI BAND WI-FI 6E/7 PCB ANTENNA with MHF1 connector and 50mm cable	u.FL/IPEX-1/MHF1
AANI-FB-0083-0050W	TRI BAND WI-FI 6E/7 PCB ANTENNA with MHF4 connector and 50mm cable	w.FL/IPEX-4/MHF4
AANI-FB-0083-0100I	TRI BAND WI-FI 6E/7 PCB ANTENNA with MHF1 connector and 100mm cable	u.FL/IPEX-1/MHF1
AANI-FB-0083-0100W	TRI BAND WI-FI 6E/7 PCB ANTENNA with MHF4 connector and 100mm cable	w.FL/IPEX-4/MHF4
AANI-FB-0083-0150I	TRI BAND WI-FI 6E/7 PCB ANTENNA with MHF1 connector and 150mm cable	u.FL/IPEX-1/MHF1
AANI-FB-0083-0150W	TRI BAND WI-FI 6E/7 PCB ANTENNA with MHF4 connector and 150mm cable	w.FL/IPEX-4/MHF4
AANI-FB-0083-0200I	TRI BAND WI-FI 6E/7 PCB ANTENNA with MHF1 connector and 200mm cable	u.FL/IPEX-1/MHF1
AANI-FB-0083-0200W	TRI BAND WI-FI 6E/7 PCB ANTENNA with MHF4 connector and 200mm cable	w.FL/IPEX-4/MHF4
AANI-FB-0083-0250I	TRI BAND WI-FI 6E/7 PCB ANTENNA with MHF1 connector and 250mm cable	u.FL/IPEX-1/MHF1
AANI-FB-0083-0250W	TRI BAND WI-FI 6E/7 PCB ANTENNA with MHF4 connector and 250mm cable	w.FL/IPEX-4/MHF4

Note: Different cable and connector configurations that are not listed may be available upon request via [Abracon online support](#)



5101 Hidden Creek Ln Spicewood TX 78669  
 Phone: 512-371-6159 | Fax: 512-351-8858  
 For terms and conditions of sales, please visit:  
[www.abracon.com](http://www.abracon.com)

**REVISED: 08-12-24**

ABRACON IS  
 ISO9001-2015  
 CERTIFIED

# TRI BAND WI-FI 6E/7 PCB ANTENNA



**AANI-FB-0083**

Request Samples



Check Inventory



**41 x 9 x 0.7 mm**  
**RoHS Compliant**  
**MSL Level = N/A**

## Product Dimensions

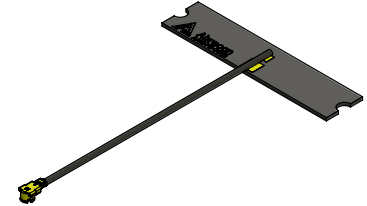
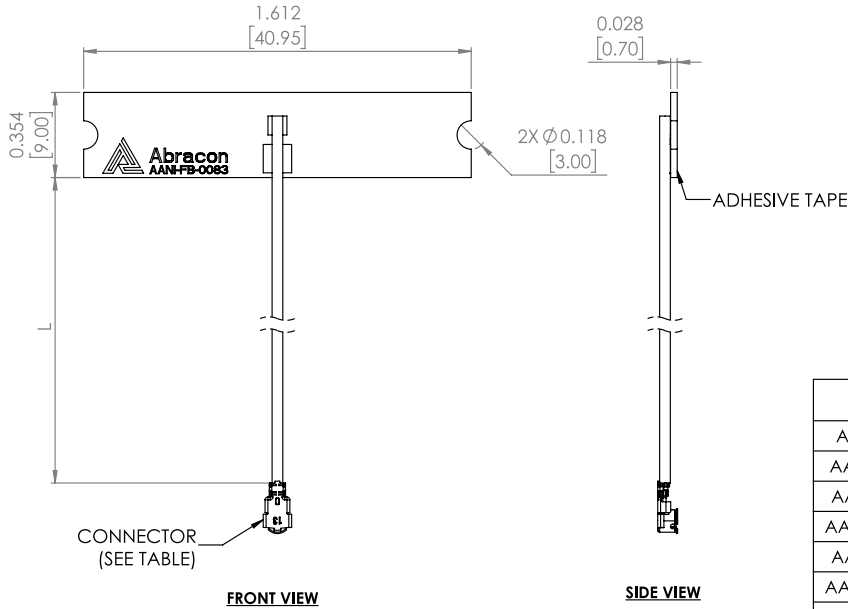

PART NUMBER	CABLE LENGTH (L)	CONNECTOR
AANI-FB-0083-0050I	1.968[50]	u.FL/IPEX-1/MHF1
AANI-FB-0083-0050W	1.968[50]	w.FL/IPEX-4/MHF4
AANI-FB-0083-00100I	3.937[100]	u.FL/IPEX-1/MHF1
AANI-FB-0083-00100W	3.937[100]	w.FL/IPEX-4/MHF4
AANI-FB-0083-00150I	5.905[150]	u.FL/IPEX-1/MHF1
AANI-FB-0083-00150W	5.905[150]	w.FL/IPEX-4/MHF4
AANI-FB-0083-00200I	7.874[200]	u.FL/IPEX-1/MHF1
AANI-FB-0083-00200W	7.874[200]	w.FL/IPEX-4/MHF4
AANI-FB-0083-00250I	9.842[250]	u.FL/IPEX-1/MHF1
AANI-FB-0083-00250W	9.842[250]	w.FL/IPEX-4/MHF4
AANI-FB-0083-00300I	11.811[300]	u.FL/IPEX-1/MHF1
AANI-FB-0083-00300W	11.811[300]	w.FL/IPEX-4/MHF4

### CONNECTOR

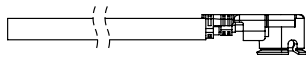

u.FL/IPEX-1/MHF1

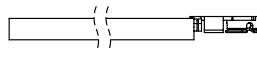

w.FL/IPEX-4/MHF4

Unit : inches[mm]

# TRI BAND WI-FI 6E/7 PCB ANTENNA



AANI-FB-0083

Request Samples



Check Inventory



41 x 9 x 0.7 mm  
RoHS Compliant  
MSL Level = N/A

## Measurement Setup photo

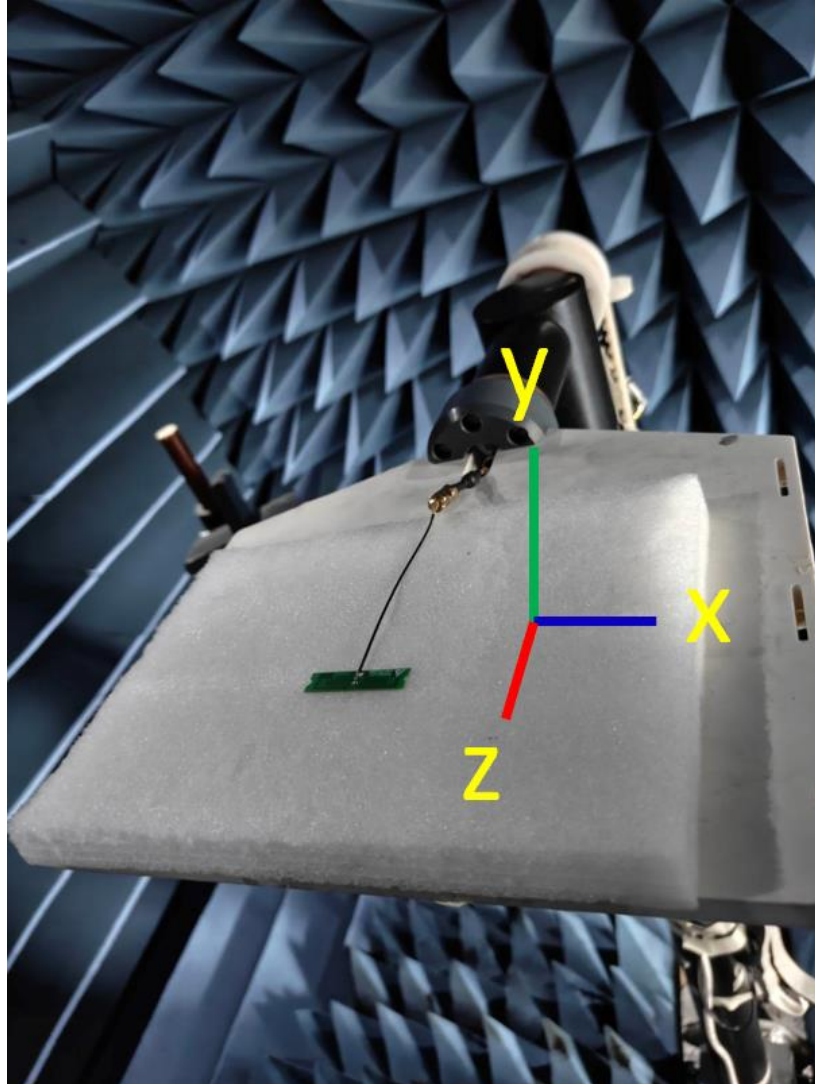

# TRI BAND WI-FI 6E/7 PCB ANTENNA



AANI-FB-0083

Request Samples



Check Inventory



41 x 9 x 0.7 mm  
RoHS Compliant  
MSL Level = N/A

## Reflection Characteristics – Return Loss & VSWR

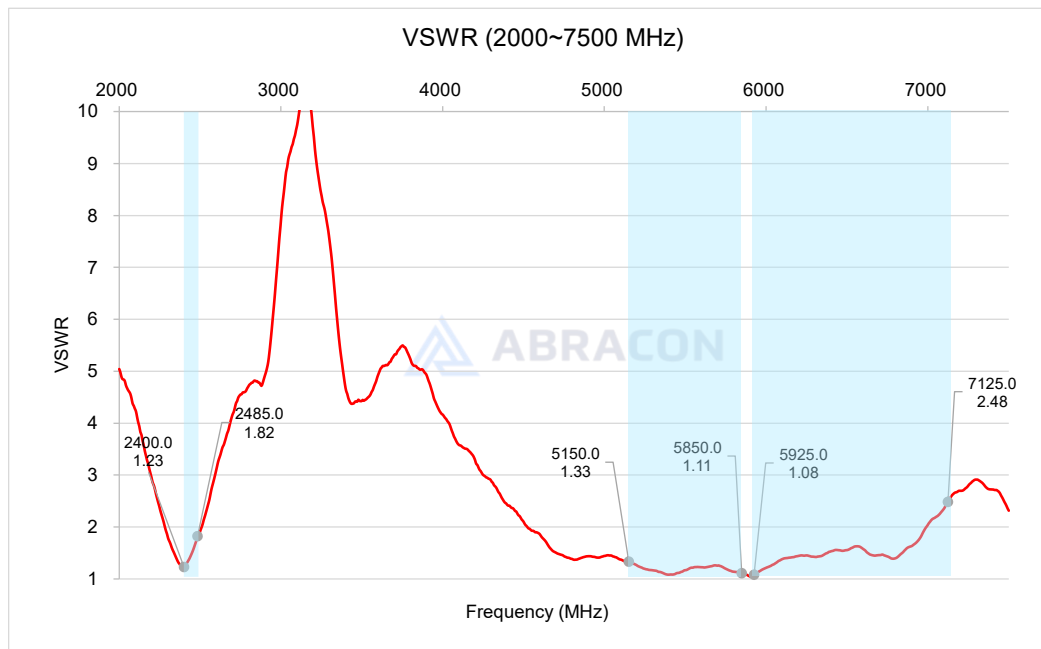
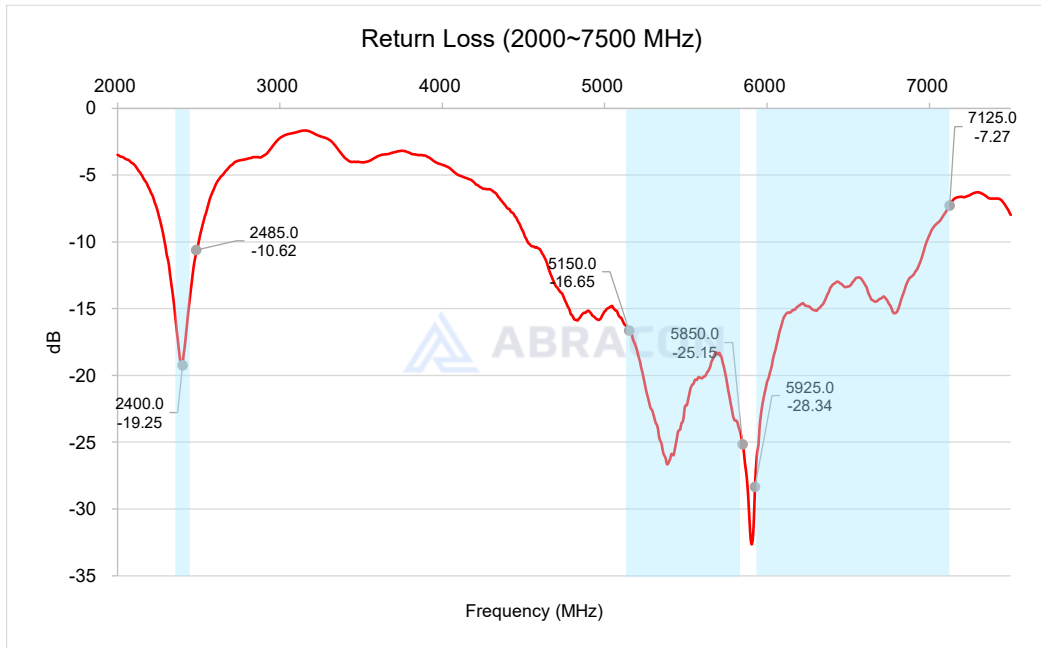

5101 Hidden Creek Ln Spicewood TX 78669  
Phone: 512-371-6159 | Fax: 512-351-8858  
For terms and conditions of sales, please visit:  
[www.abracon.com](http://www.abracon.com)

REVISED: 08-12-24

ABRACON IS  
ISO9001-2015  
CERTIFIED

# TRI BAND WI-FI 6E/7 PCB ANTENNA



**AANI-FB-0083**

Request Samples



Check Inventory



**41 x 9 x 0.7 mm**  
**RoHS Compliant**  
MSL Level = N/A

## Radiation Characteristics – Peak Gain

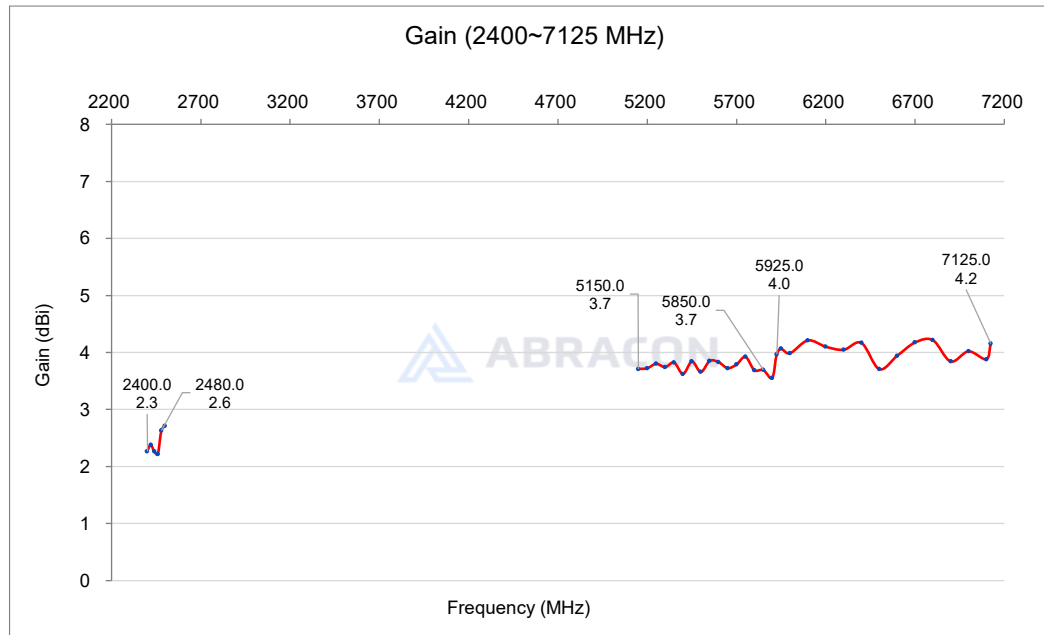

# TRI BAND WI-FI 6E/7 PCB ANTENNA



**AANI-FB-0083**

Request Samples



Check Inventory



**41 x 9 x 0.7 mm**  
**RoHS Compliant**  
MSL Level = N/A

## Radiation Characteristics – Total Efficiency (%)

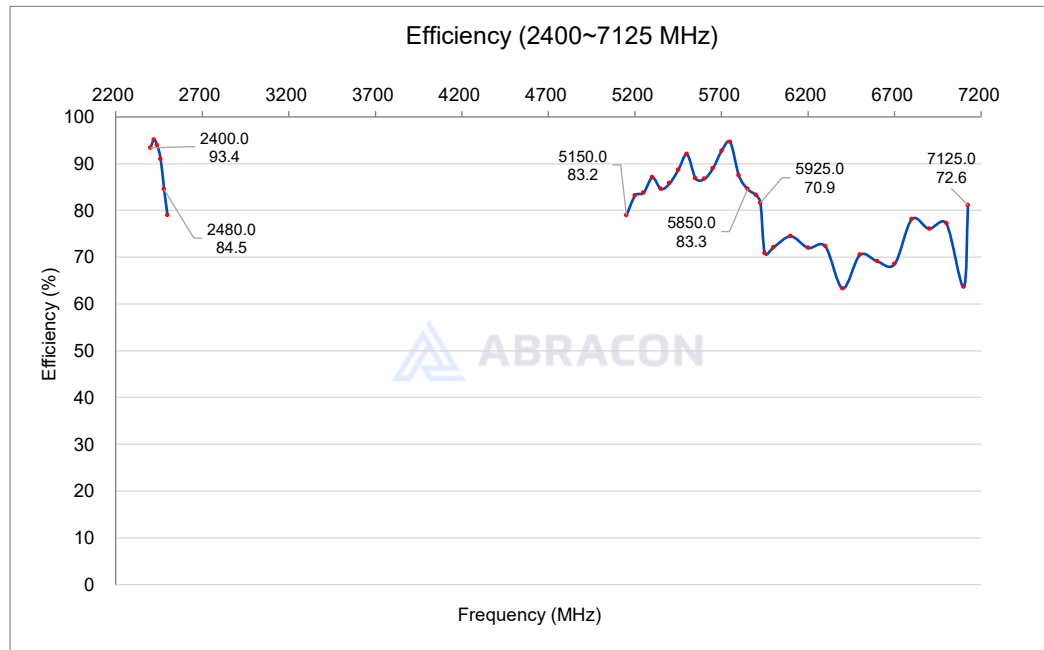



# TRI BAND WI-FI 6E/7 PCB ANTENNA



AANI-FB-0083

Request Samples



Check Inventory



41 x 9 x 0.7 mm  
RoHS Compliant  
MSL Level = N/A

## Radiation Characteristics – 3D & 2D pattern

2450MHz

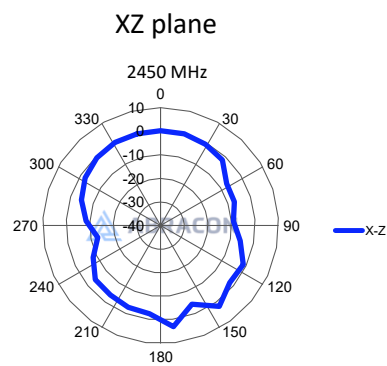
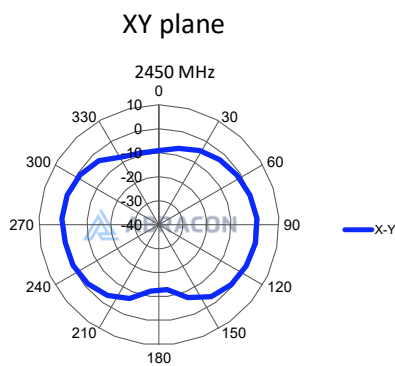
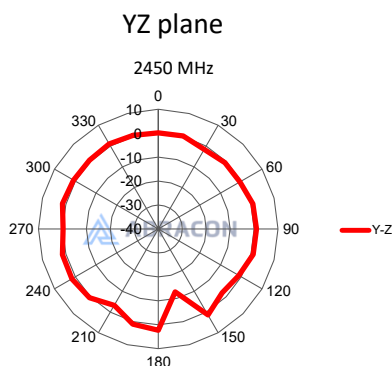
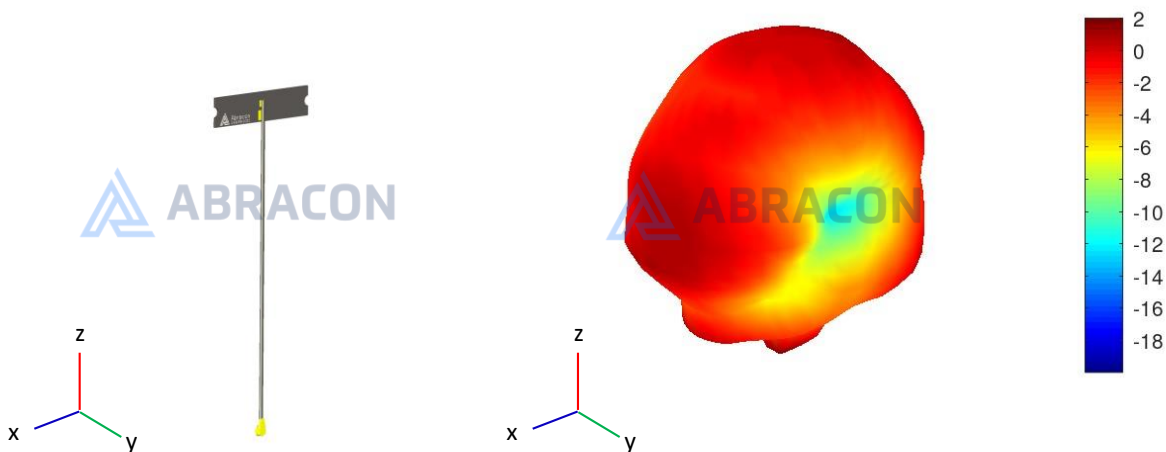

# TRI BAND WI-FI 6E/7 PCB ANTENNA



AANI-FB-0083

Request Samples



Check Inventory



41 x 9 x 0.7 mm  
RoHS Compliant  
MSL Level = N/A

5550MHz

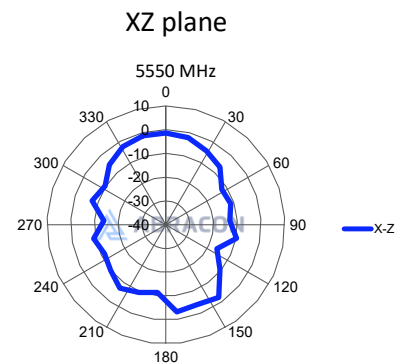
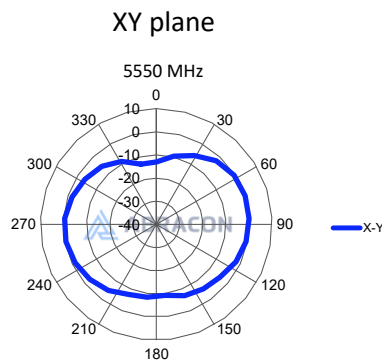
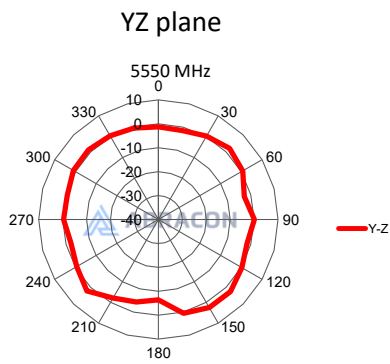
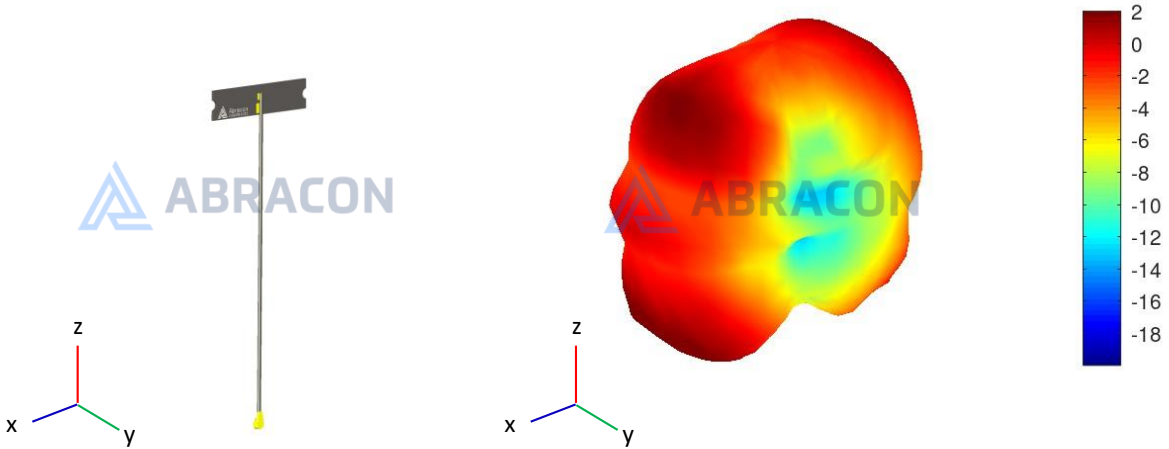

# TRI BAND WI-FI 6E/7 PCB ANTENNA



**AANI-FB-0083**

Request Samples



Check Inventory



**41 x 9 x 0.7 mm**  
**RoHS Compliant**  
**MSL Level = N/A**

6525MHz

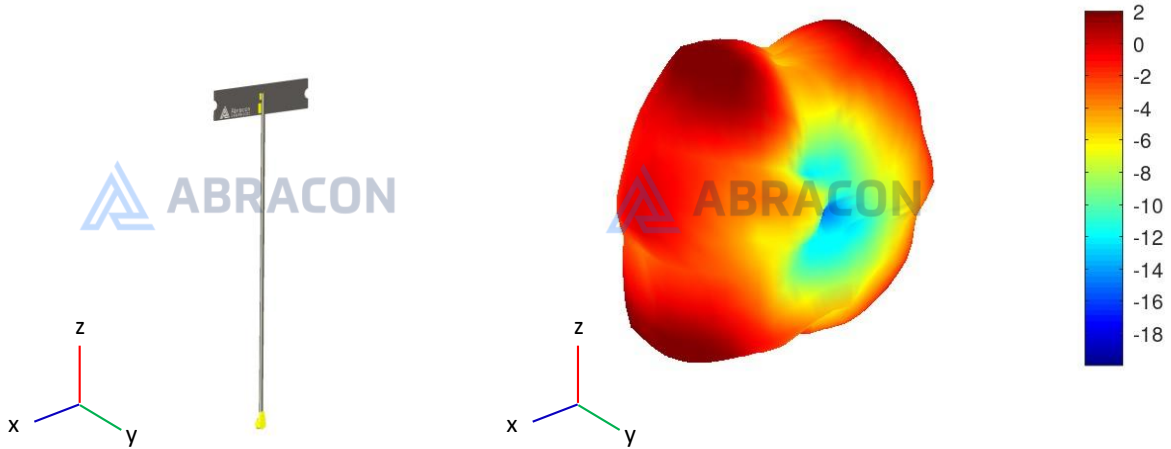

YZ plane

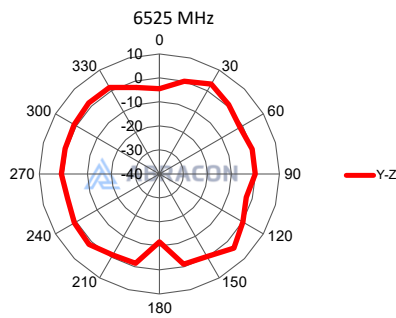

XY plane

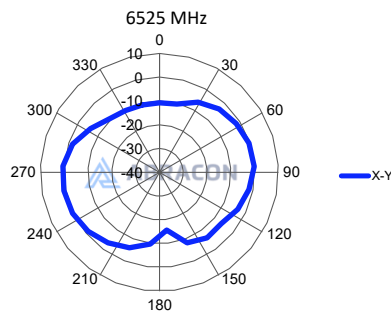

XZ plane

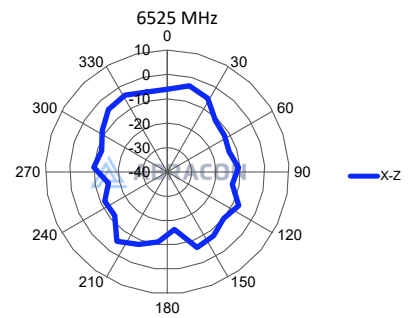

# TRI BAND WI-FI 6E/7 PCB ANTENNA



**AANI-FB-0083**

Request Samples



Check Inventory



**41 x 9 x 0.7 mm**  
**RoHS Compliant**  
**MSL Level = N/A**

## Packaging

Number of Antenna/ bags: 50 pcs

Total Pcs / package: 1000 pcs

**ATTENTION:** Abracon LLC's products are Commercial-Off-The-Shelf ("COTS"), which are designed, intended, and validated for use in commercial, industrial, and automotive applications. The customer is responsible for testing and verifying the performance of an Abracon solution to meet their system-level requirements.



5101 Hidden Creek Ln Spicewood TX 78669  
Phone: 512-371-6159 | Fax: 512-351-8858  
For terms and conditions of sales, please visit:  
[www.abracon.com](http://www.abracon.com)

**REVISED: 08-12-24**

ABRACON IS  
ISO9001-2015  
CERTIFIED