

Overview

KEMET's VS vibration sensors can detect vibrations in a wide frequency range from 10 Hz up to 15 kHz, through the effective conversion of vibrations to electrical signal by utilizing proprietary optimized piezo ceramic material and original vibration amplifying design. As no amplifier is required, it makes it very easy to embed.

Its ability to detect even the faintest levels of vibration throughout a large sensing bandwidth makes it ideal for predictive maintenance and process control operations in industrial IoT, allowing for correction and data analysis flow to PLC, micro-computer or analyzers.

Benefits

- Proprietary piezo ceramic material
- High sensitivity
- Large sensing bandwidth
- Built-in amplifier

J Type

- Unique detachable cable design for easy installation
- Compact and low-profile (Ø 18.0 × 11.0 mm)
- Waterproof and oil-resistant
- Case-insulated
- Current noise resistant

VS-JV10A, VS-JV02A



Applications

Typical applications include abnormal vibration detection and condition monitoring of production facilities of all industries, motors, bearings, and pumps.

B Type

- Integrated cable
- Ultra compact and ultra low-profile (8.4 x 11.4 x 2.9 mm)
- Easy to embed

VS-BV203-B



Ordering Information

VS-	J	V	10		A	-K01
Series	Model Type	Output Type	Sensitivity	Interface	Version	Accessories
VS = Vibration Sensor	B J	V = Voltage C = Current	02 = 2 mV/m/s ² 10 = 10 mV/m/s ² 20 = 20 mV/m/s ²	Blank = M8 connector type 3 = Integrated 3m cable type	A B	Blank = Without accessory K01 = Cable + magnet + stud for J type sensor K02 = Cable for J type sensor K03 = Cable + magnet for J type sensor K04 = Cable + stud for J type sensor

Environmental Compliance

All KEMET Vibration Sensors are RoHS and REACH Compliant.



Article 33(1) of the REACH Regulation states that manufacturers and importers of articles (products) are required to notify their customers of the presence of any Substances of Very High Concern (SVHC) in their products exceeding 0.1% by weight and provide instructions on safe use of the product.

KEMET Corporation reports regarding the Article 33(1) of REACH Regulation as follows:

1. Applicable Product: Vibration Sensors (VS series)

2. Report for the content of REACH SVHC list:

The product(s) above contains a substance by more than 0.1wt% per product weight that was published in the 8th update of the REACH SVHC substances (December 19, 2012).

3. Regarding the safety of the vibration sensors (Piezoceramic products):

The Piezoceramic that is used in this product becomes ceramic by sintering powder containing PZT as the main ingredient. It is chemically stable, with minimum risks toward the human body or environment within the intended use of the product. Please note that risks could occur in the case of inhalation or accidental oral uptake of powder ceramics.

4. Technical product information on the vibration sensors (Piezoceramic products):

The manufacturing technique of the "piezoceramic products" whose main ingredient is Lead Titanium Zirconium Oxide (PZT) has been established, and there is no alternative material that can exhibit superior performance than PZT at this moment. Please note that the piezoceramic is listed as an exempt on RoHS (2011/65/EU) AnnexIII (7c.1).

5. The responsibility of piezoceramic manufacturers:

Piezoceramic manufacturers report information regarding PZT containment in their products to the customers to obey the article 33 of the REACH regulation

Approvals

The KEMET vibration sensors are designed according to following standards:

VS-JV10A

Standard		Certification Body	File Number
CE	IEC 61000-6-4:2018 (EMI)	TEE	T1860701
	IEC 61000-6-2:2016 (EMC)	TEE	T1860701
IP67 (equivalent) ¹	EN 50581:2012	TÜV	20180920

¹ With the connector inserted and tightened.

VS-BV203-B

Standard		Certification Body	File Number
CE	IEC 61000-6-4:2018 (EMI)	TEE	T1860702
	IEC 61000-6-2:2016 (EMC)	TEE	T1860702

Area of Acceleration Detection

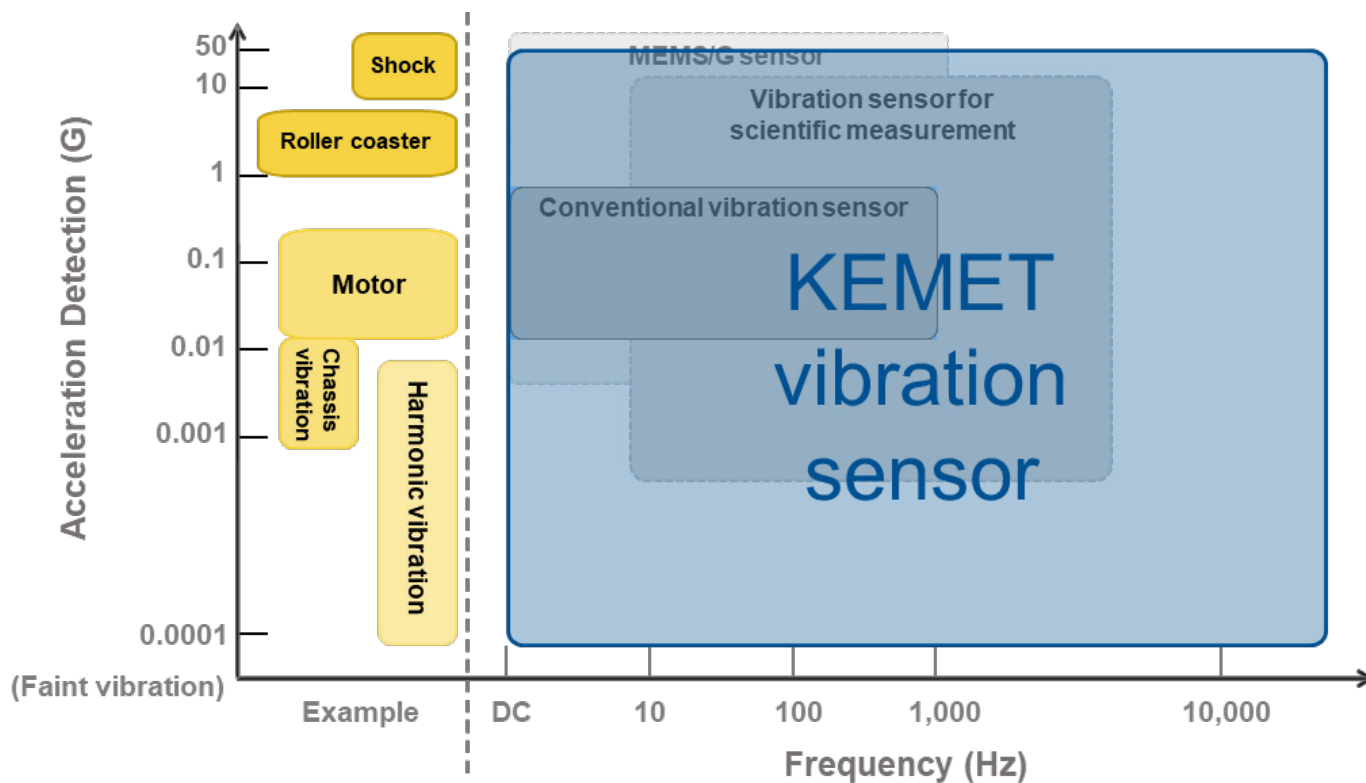

Table 1A - Ratings & Part Number Reference - Dynamic Characteristics

Part Number	Sensitivity (mV/m/s ²) at 160 Hz, Z axis ¹	Sensitivity Tolerance	Measuring Range (m/s ²) at 160 Hz	Frequency Range (Hz)	Resonant Frequency (kHz)
VS-JV10A	10	±15%	±100	10 to 15,000	> 30
VS-JV02A	2		±500		
VS-BV203-B	20		±50		

¹ Measurement axis is Z axis only.

Table 1B - Ratings & Part Number Reference - Electrical Characteristics

Part Number	Power Supply Voltage (V) Typical	Current Consumption (mA) Typical	Offset Voltage (V)	Acceleration Noise Density (m/s ² /√Hz) at 160 Hz	Grounding	Protection Class
VS-JV10A	3.2 to 5.5 (5 V typical)	0.50	1.5 center voltage value	0.003	Case-insulated	III
VS-JV02A	3.2 to 5.5 (5 V typical)	0.50	1.5 center voltage value		Case-insulated	III
VS-BV203-B	3.0 to 5.5 (3.3 V typical)	0.35	1/2 power supply voltage		Case-grounded	III

All values are typical at 25°C, 5 V.

Table 1C - Ratings & Part Number Reference - Environmental Characteristics

Part Number	Operating Temperature Range (°C)	Storage Temperature Range (°C)	Operating Humidity Range ^{1 & 2} (%RH)	Storage Humidity Range ² (%RH)	Impact Resistance (Shock) (G)	Weight ³ (g)
VS-JV10A	-25 to +85	-25 to +85	10 to 90	10 to 90	1,000	19
VS-JV02A	-25 to +85	-25 to +85				19
VS-BV203-B	-25 to +75	-25 to +75				1

¹ Assuming no condensation.

² In ambient temperature 40°C or less, 90%RH (maximum). In ambient temperature exceeding 40°C, the absolute humidity is less than 90% R.H. by Temperature = 40°C conversion.

³ Without cable.

Sensitivity

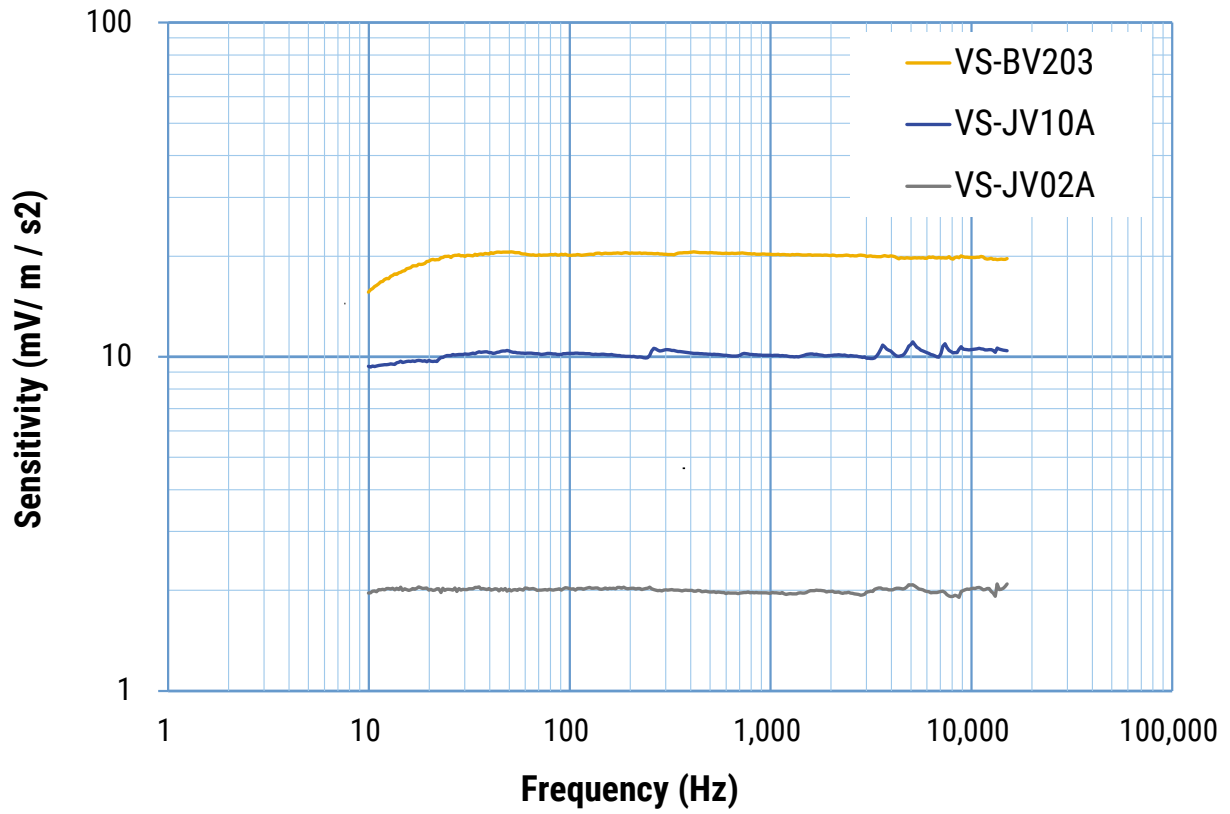

Dimensions - Millimeters

VS-JV10A, VS-JV02A

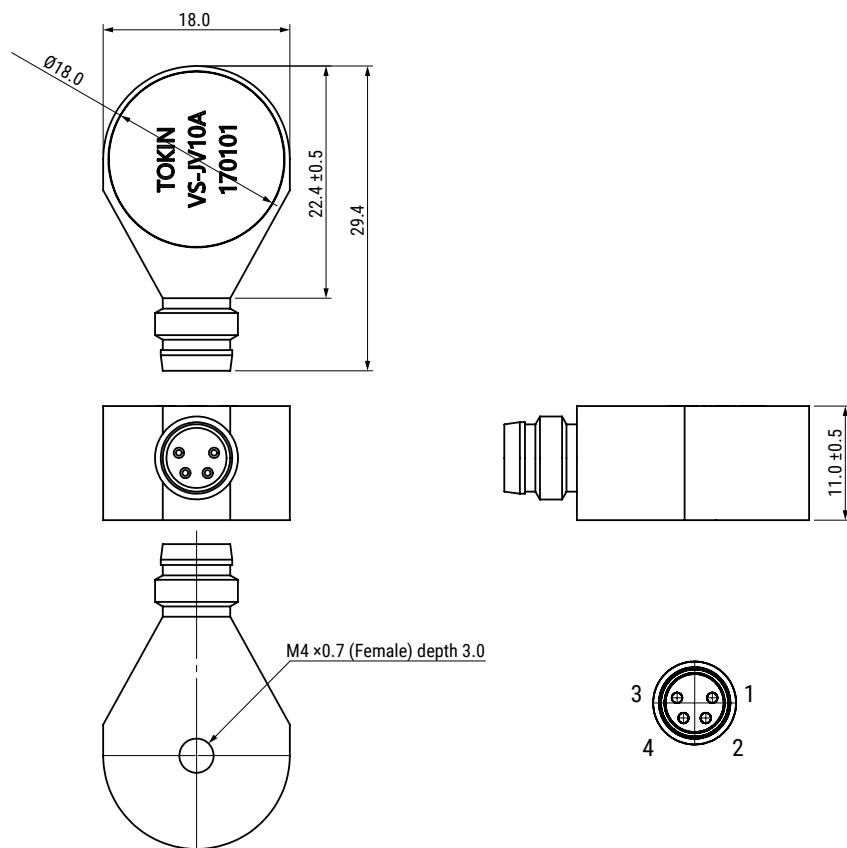

Pin Assignment	Symbol	Function
1	V_{IN}	Power input
2	V_{OUT}	Sensor output
3	SG	Signal ground
4	N.C.	N/A





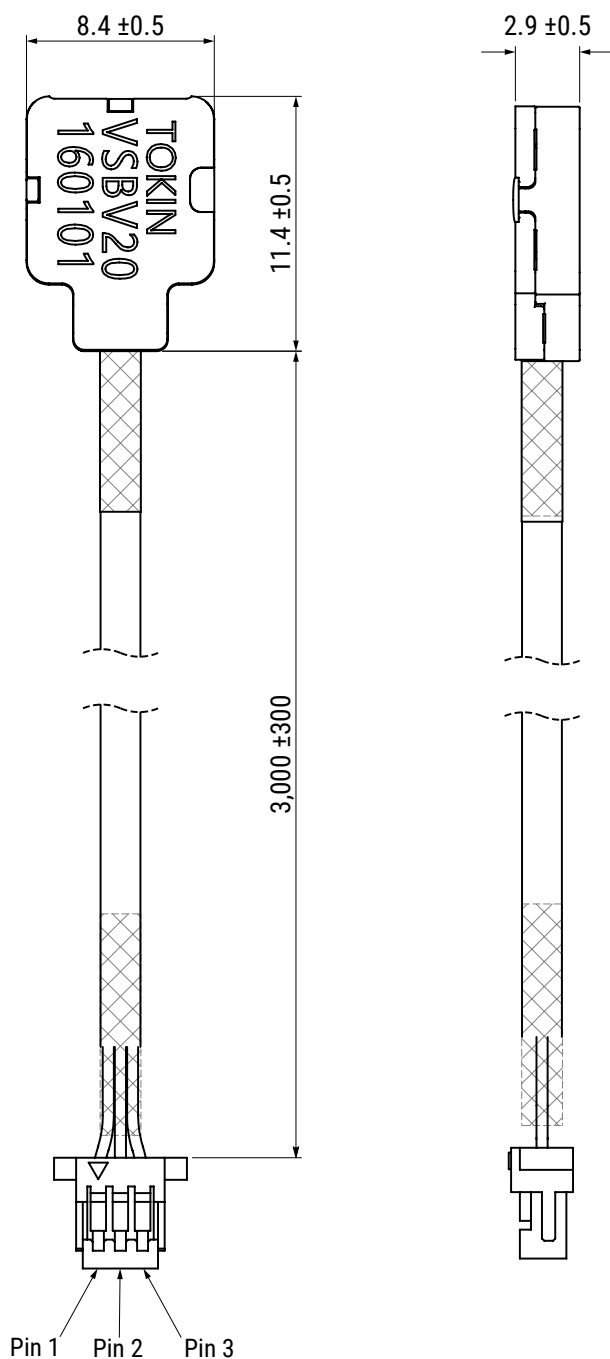





Dimensions - Millimeters cont.

VS-BV203-B



Pin Assignment	Symbol	Function
1	V_{IN}	Power input
2	V_{OUT}	Sensor output
3	GND	Ground

Accessories

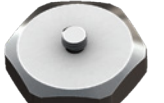
Part Number	Sensor VS-JV10A or VS-JV02A	Cable VSC-100PURS4-M8D-01	Magnet Base VM-03	Mounting Stud VA-01
VS-JV10A-K01 VS-JV02A-K01				
VS-JV10A-K02 VS-JV02A-K02				
VS-JV10A-K03 VS-JV02A-K03				
VS-JV10A-K04 VS-JV02A-K04				

Cable & Connector VSC-100PURS4-M8D-01 - Millimeters

Cable Length: 10 m

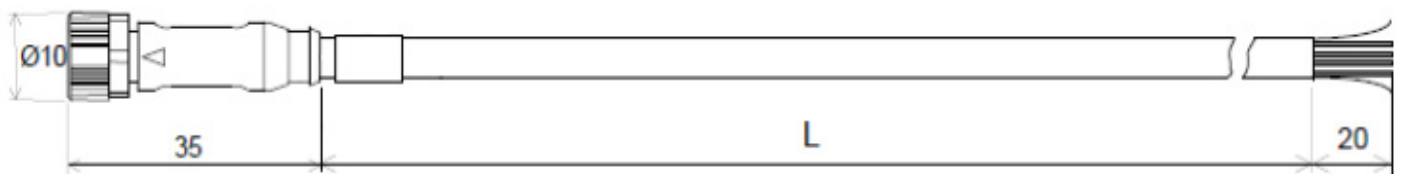

M8 Connector

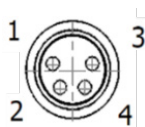

- Pin 1: Brown/ V_{IN}
- Pin 2: White/ V_{OUT}
- Pin 3: Blue/SG (Signal Ground)
- Pin 4: Black/N.C.

Accessories cont.

Basic Configuration

Product Name	Jacket Material	Outer Diameter (mm)	Cable Length (m)	Conductor (mm ²)	Connector	Tightening Torque (Nm)
VSC-100PURS4-M8D-01	PUR	φ5.3	10	0.34 (similar to AWG22)	M8 (female))	0.4

Connection

Pin Assignment	Wire Color	Symbol	Function ¹
1	Brown	V _{IN}	Power input
2	White	V _{OUT}	Sensor output
3	Blue	SG	Signal ground
4	Black	N.C.	N/A
Other conductor	Shield	FG	Frame ground

¹ When connected to VS-JV10A.

Magnet Base VM-03 - Millimeters

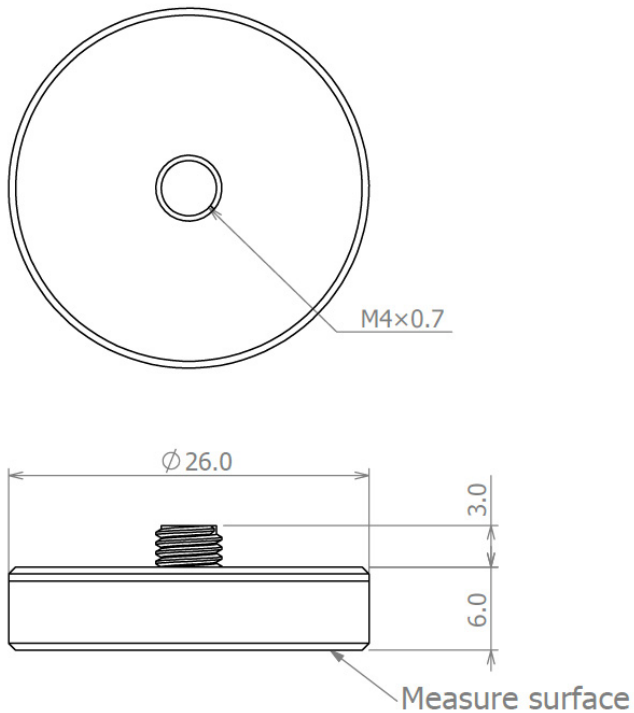

Basic Configuration

Product Name	Material	Dimensions (mm)	Mounting (mm)	Mounting Torque (Nm)	Attractive Force ¹ (N)	Weight (g)
VM-03	SUS430	φ26×6 (excluding protruding part)	M4×0.7	1.5	> 40	23

¹ Attractive surface: SS400 and for conditions where ambient temperature is 25°C.

Accessories cont.

Mounting Stud VA-01 - Millimeters

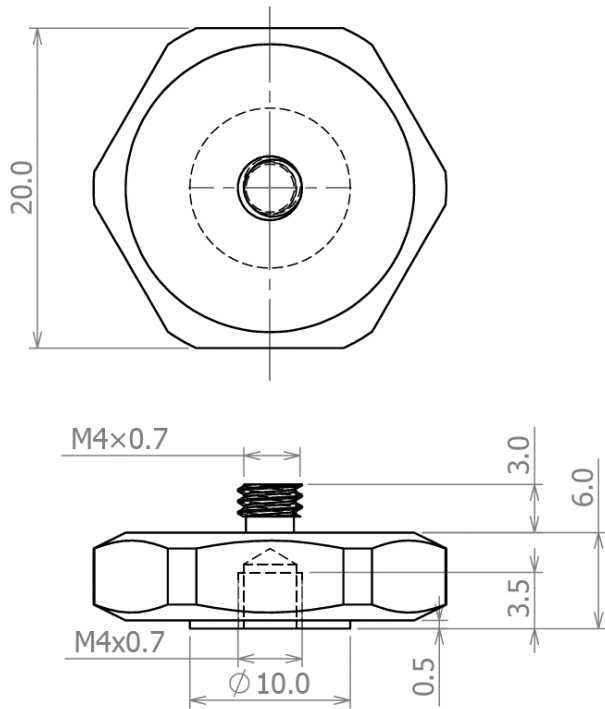

Basic Configuration

Product Name	Material	Dimensions (mm)	Mounting (mm) Sensor Mounting	Mounting (mm) Grounding	Mounting Torque (Nm)	Weight (g)
VA-01	SUS303	φ22×6 (excluding protruding part)	M4×0.7	M4×0.7/Adhesive	1.5	14

Marking

VS-JV10A, VS-JV02A

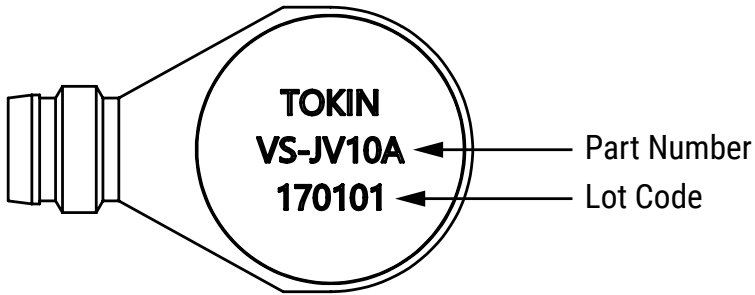

VS-BV203-B

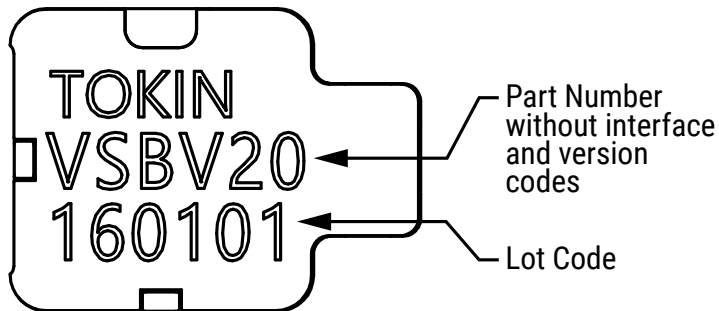

Lot Code	
1st and 2nd digit = Last two digits of Year	xx = 20xx
3rd and 4th digit = Month of the Year	01 = January 02 = February to 11 = November 12 = December
5th and 6th digit = Serial Number	01 02 03 etc.

Packaging

Part Number	Packaging Type	Pieces per Inner Box	Pieces per Outer Box
VS-JV10A	Box	1	100
VS-JV10A-K01	Box	1	10
VS-JV10A-K02	Box	1	10
VS-JV10A-K03	Box	1	10
VS-JV10A-K04	Box	1	10
VS-JV02A	Box	1	100
VS-JV02A-K01	Box	1	10
VS-JV02A-K02	Box	1	10
VS-JV02A-K03	Box	1	10
VS-JV02A-K04	Box	1	10
VS-BV203-B	Box	1	100

Handling Precautions

Vibration Sensor VS-JV10A, VS-JV02A

- To secure the sensor body with screws, use M4 screws with a standard mounting torque (1.5 Nm).
- Tighten the M8 connector with the torque specified for the cable to be used. The specified torque for the standard cable is 0.4Nm.
- When connecting the connector, align the pins on the sensor and cable, and fully insert the cable before tightening the screw.

Cable & Connector VSC-100PURS4-M8D-01

- Please tighten the M8 connector with the specified torque (0.4Nm) of a standard cable before use.
- When connecting the connector, align the pins on the sensor and cable, and fully insert the cable before tightening the screw.

Magnet Base VM-03

- Use a tightening torque 1.5 Nm when screwing the vibration sensor onto the magnet base.
- Vibration measurements undertaken using the magnet base are affected by both the materials and surface conditions of the attached surface, which changes the output characteristics of the sensor. Please test and confirm operation in the specific target environment before use.
- Since strong magnets base are used, be careful not to allow your hand to become caught between several magnet bases or between a magnet base and a metal object.
- Do not place the magnet base close to mobile phones, analog clocks, magnetic cards, magnetic tapes, etc. This can result in the loss of stored information.
- Be aware that improperly stored magnet bases are dangerous, as they may strongly attract nearby magnets and metal objects.

Mounting Stud VA-01

- Use a tightening torque 1.5 Nm when screwing the vibration sensor onto the mounting stud.
- Vibration measurements undertaken using the magnet base are affected by both the materials and surface conditions of the attached surface, which changes the output characteristics of the sensor. Please test and confirm operation in the specific target environment before use.

Handling Precautions cont.

Vibration Sensors in General

- For outdoor usage and usage in special environments that exceed the conditions given in this product specification, please test and confirm operation in the specific target environment before use.
- Hold the connector body when attaching or detaching the connector.
- Do not touch the mating face with wet hands.
- Make sure to wipe off any moisture present on or near the connector before use.
- Do not pull on the connector or the cable. This can break the connector or disconnect the cable.
- This product detects vibration and may be affected by cable vibrations, depending on the installation conditions. It is recommended that the cable be slightly slack and fixed to a stationary surface or the same surface as the sensor.
- When using the sensor, connect a load resistance of 100kΩ or higher to the sensor output terminals.
- This sensor uses ceramic material and are breakable in case of strong shocks due to drop, etc.
- Do not touch the sensor body or cable during operation. This can cause malfunction.
- Avoid installations conditions where pressure is continuously applied to the sensor, e.g., installation where the sensor body is sandwiched or exposed to an applied pressure. This can lead to distortion of the case, which will adversely affect sensor performance, and may cause breakage.
- Any modifications to the sensor after shipping will invalidate the warranty.
- In mission critical applications, we urge users to take appropriate measures, such as providing redundancy, to prevent a large effect on operation of the customer's products and systems in the event of sensor failures.
- Do not operate or store in dusty high temperature environment, near fire, under strong light or sunshine, in the air containing salt or oil.
- KEMET recommends that maximum storage temperature not exceed 85°C for VS-JV10A, VS-JV02A and 75°C for VS-BV203-B and maximum storage humidity not exceed 90% relative humidity and atmospheres should be free of chlorine and sulfur bearing compounds. Temperature fluctuations should be minimized to avoid condensation on the parts.
- Handle products properly as industrial waste. When disposing, please contact your local waste disposal service and make sure the disposal methods meet all legal requirements.
- Vibration sensors' stock should be used promptly, preferably within 1 year of receipt.

KEMET Electronics Corporation Sales Offices

For a complete list of our global sales offices, please visit www.kemet.com/sales.

Disclaimer

YAGEO Corporation and its affiliates do not recommend the use of commercial or automotive grade products for high reliability applications or manned space flight.

All product specifications, statements, information and data (collectively, the "Information") in this datasheet are subject to change. The customer is responsible for checking and verifying the extent to which the Information contained in this publication is applicable to an order at the time the order is placed. All Information given herein is believed to be accurate and reliable, but it is presented without guarantee, warranty, or responsibility of any kind, expressed or implied.

Statements of suitability for certain applications are based on KEMET Electronics Corporation's ("KEMET") knowledge of typical operating conditions for such applications, but are not intended to constitute – and KEMET specifically disclaims – any warranty concerning suitability for a specific customer application or use. The Information is intended for use only by customers who have the requisite experience and capability to determine the correct products for their application. Any technical advice inferred from this Information or otherwise provided by KEMET with reference to the use of KEMET's products is given gratis, and KEMET assumes no obligation or liability for the advice given or results obtained.

Although KEMET designs and manufactures its products to the most stringent quality and safety standards, given the current state of the art, isolated component failures may still occur. Accordingly, customer applications which require a high degree of reliability or safety should employ suitable designs or other safeguards (such as installation of protective circuitry or redundancies) in order to ensure that the failure of an electrical component does not result in a risk of personal injury or property damage.

Although all product-related warnings, cautions and notes must be observed, the customer should not assume that all safety measures are indicated or that other measures may not be required.

When providing KEMET products and technologies contained herein to other countries, the customer must abide by the procedures and provisions stipulated in all applicable export laws and regulations, including without limitation the International Traffic in Arms Regulations (ITAR), the US Export Administration Regulations (EAR) and the Japan Foreign Exchange and Foreign Trade Act.

KEMET is a registered trademark of KEMET Electronics Corporation.