



# TAOGLAS®



# Datasheet

**Part No:**  
*MA343.W.LBI.001*

**Description**

3-in-1 White Magnet Mount GNSS and 2x 4G LTE MIMO  
With 2m of RG-174 Cable and SMA(M) Connectors

**Features:**

Low-profile Magnetic Mount Antenna  
2\* 4G/LTE MIMO covering 600-6000MHz  
1\* GPS-GLONASS  
Dims: 58mm \* 58mm \* 65mm  
Cable: 2m of RG174  
Connector: SMA(M)  
RoHS & Reach Compliant

<b>1.</b>	<b>Introduction</b>	<b>3</b>
<b>2.</b>	<b>Specification</b>	<b>4</b>
<b>3.</b>	<b>Mechanical Drawing</b>	<b>7</b>
<b>4.</b>	<b>Packaging</b>	<b>8</b>
<b>5.</b>	<b>Antenna Characteristics</b>	<b>9</b>
<b>6.</b>	<b>LNA Characteristics</b>	<b>15</b>
<b>7.</b>	<b>Radiation Patterns</b>	<b>18</b>
<hr/>		
	Changelog	48

Taoglas makes no warranties based on the accuracy or completeness of the contents of this document and reserves the right to make changes to specifications and product descriptions at any time without notice. Taoglas reserves all rights to this document and the information contained herein. Reproduction, use or disclosure to third parties without express permission is strictly prohibited.

Ireland & USA  
ISO 9001:2015  
Certified



Taiwan  
ISO 9001:2015  
Certified



# 1. Introduction



The Taoglas MA343 magnetic mount antenna is a high performance 3-in-1 combination antenna with GNSS and 2x 5G/4G MIMO. The robust, compact housing is just at only 65mm tall and 58mm in diameter, it is an ideal for external antenna for assets requiring GNSS, Cellular and Wi-Fi connectivity.

The GPS/GLONASS/Galileo antenna has stable gain and radiation patterns on all bands. The 5G/4G antenna, covers all worldwide LTE bands, includes many sub 6GHz, 5G FR1 bands and includes fallback to 3G/2G bands where required.

The IP67 rated enclosure is made from a durable, UV resistant ASA material that makes it resistant to vandalism or impact. An integrated rubber O-ring under the enclosure prevents water ingress under the antenna. It is mounted from the inside of the user device enclosure and the small thread allows for installation in situations where space is minimal.

Typical applications include:

- Smart Metering and Remote Monitoring
- Digital Signage
- Transportation and Telematics

Cable type and length, and connectors are fully customizable, and the MA343 can also be customized for other configurations. It is also available in black (MA343.A.LBI.001). Contact your regional Taoglas customer support team for more information.

## 2. Specification

GNSS Frequency Bands					
GPS	L1 1575.42 MHz	L2 1227.6 MHz	L5 1176.45 MHz		
	■	□	□		
GLONASS	G1 1602 MHz	G2 1248 MHz	G3 1207 MHz		
	■	□	□		
Galileo	E1 1575.24 MHz	E5a 1176.45 MHz	E5b 1201.5 MHz	E6 1278.75 MHz	
	■	□	□	□	
BeiDou	B1C 1575.42 MHz	B1I 1561 MHz	B2a 1176.45 MHz	B2b 1207.14 MHz	B3 1268.52 MHz
	■	■	□	□	□
L-Band	L-Band 1542 MHz				
	□				
QZSS (Regional)	L1 1575.42 MHz	L2C 1227.6 MHz	L5 1176.45 MHz	L6 1278.75e6	
	■	□	□	□	
IRNSS (Regional)	L5 1176.45 MHz				
	□				
SBAS	L1/E1/B1 1575.42 MHz	L5/B2a/E5a 1176.45 MHz	G1 1602 MHz	G2 1248 MHz	G3 1207 MHz
	■	□	■	□	□

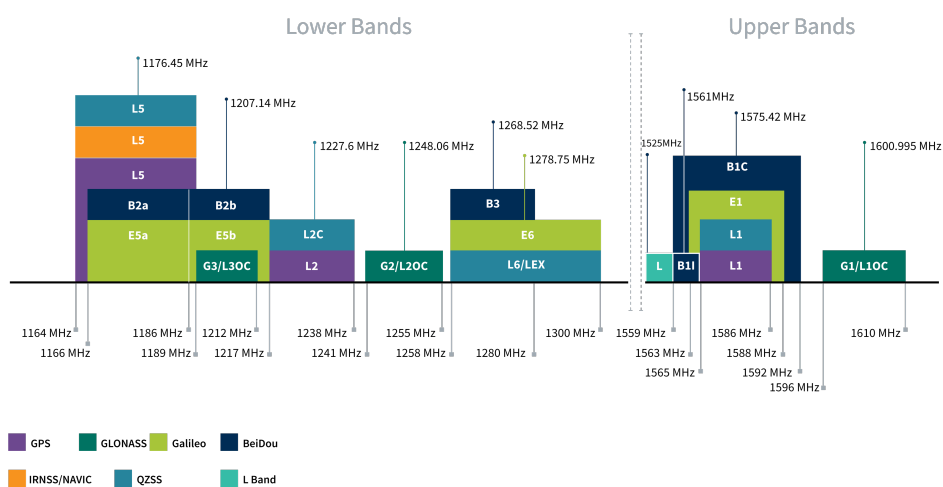

GNSS Bands and Constellations

GNSS Electrical			
Frequency (MHz)	1561	1575.42	1603
VSWR (max.)	3:1	3:1	3:1
Passive Antenna Efficiency (%)	28.22	36.12	45.39
Passive Antenna Gain (dBi)	-3.73	-1.2	-1.2
Polarization	RHCP		
Impedance	50 Ω		

LNA and Filter Electrical Properties			
Frequency (MHz)	1561	1575.42	1603
Gain (dB)	31.7	31.2	29.8
Noise (dB)	2.29	2.15	2.5
Voltage Range	1.8-5.5V		
Current Consumption	9 ± 3		
Out-off-band rejection (dB)	> 70 @700-960MHz , > 60 @ 1710-6000MHz		

LTE Electrical									
Band	Frequency (MHz)	Measurement	Efficiency (%)	Average Gain (dB)	Peak Gain (dBi)	Impedance	Polarization	Radiation Pattern	Max. input power
5GNR/4G Band71	617-698	LTE1	28.1	-5.51	-0.78	50 Ω	Linear	Omni	2W
		LTE2	24.7	-6.07	-0.91				
4G/3G Band 12,13,14,17,28,29	698-824	LTE1	44.7	-3.50	0.99				
		LTE2	43.3	-3.63	1.12				
4G/3G/NB-IoT/Cat M Band 5,8,18,19,20,26,27	824-960	LTE1	46.7	-3.31	0.99				
		LTE2	57.4	-2.41	1.55				
5GNR/4G Band 21,32,74,75,76	1427-1518	LTE1	33.2	-4.79	2.87				
		LTE2	30.6	-5.15	2.68				
4G/3G Band 1,2,3,4,9,23,25,35,39,66	1710-2200	LTE1	65.3	-1.85	5.93				
		LTE2	63.5	-1.97	5.34				
4G/3G Band 7,30,38,40,41	2300-2690	LTE1	69.0	-1.61	5.64				
		LTE2	70.9	-1.50	5.95				
5GNR/4G Band 22,42,48,77,78,79	3300-5000	LTE1	55.7	-2.54	6.84				
		LTE2	61.6	-2.10	6.70				
LTE5200/Wi-Fi5800	5150-5925	LTE1	57.3	-2.42	6.00				
		LTE2	56.4	-2.48	5.97				

### Mechanical

<b>Dimensions</b>	58 x 58 x 65mm
<b>Material</b>	ASA
<b>Connector</b>	SMA(M)
<b>Cable</b>	2m of RG174

### Environmental

<b>Temperature Range</b>	-40 - +85°C
<b>RoHs &amp; REACH Compliant</b>	Yes

### 3. Mechanical Drawing

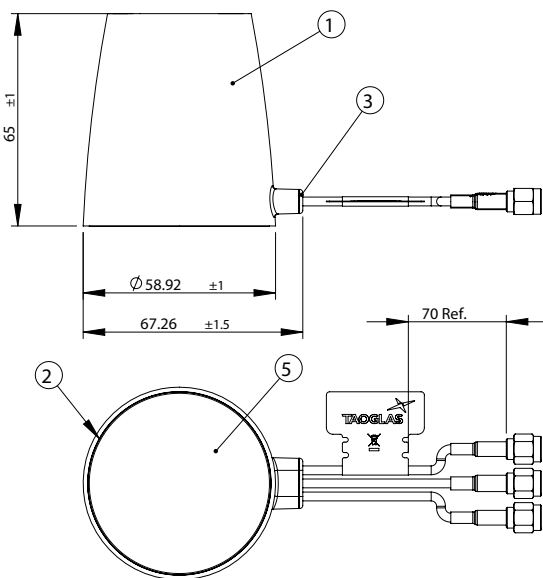
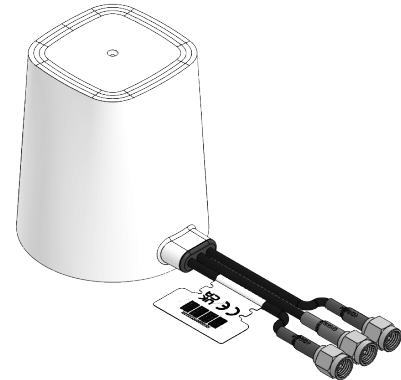
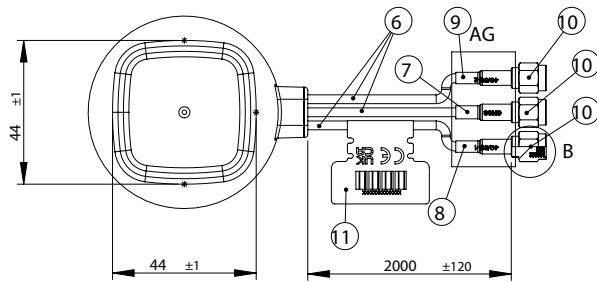

DETAIL AG  
SCALE 1 : 1

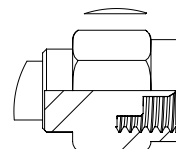

DETAIL B  
SCALE 2 : 1

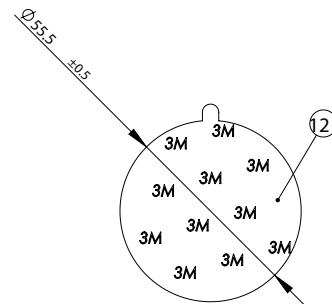

Accessory

	Name	Material	Finish	Qty
1	Top housing	ASA	White	1
2	Bottom housing	ASA	Black	1
3	Grommet	Silicone Rubber	Black	1
4	Magnet pack/N48	NdFeB	Ni Plated	1
5	Matte Silver Label	PET	Matte Silver	1
6	RG174 Coaxial Cable	PVC	Black	3
7	Heat Shrink Tube(GNSS)	PE	Blue Tube/White Text	1
8	Heat Shrink Tube(4G/5G-1)	PE	Red Tube/White Text	1
9	Heat Shrink Tube(4G/5G-2)	PE	Red Tube/White Text	1
10	SMA/MST Plug for RG-316/RG-174	Brass	Au Plated	3
11	CE,WEEE and UKCA mark logo Label	PEPA	White	1
12	Double Sided Adhesive	3M VHB 5952	Black foam/Red liner	1

## 4. Packaging

1 PCS /PE Bag  
Weight: 161g

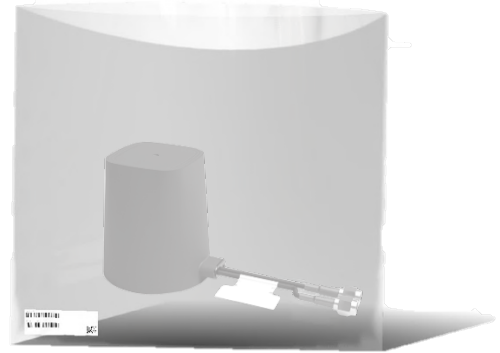

60 PCS / Carton  
Dimensions: 430 x 380 x 280mm  
Weight: 10.76Kg





## 5. Antenna Characteristics

### 5.1 Test Setup

AUT



Vector Network Analyzer

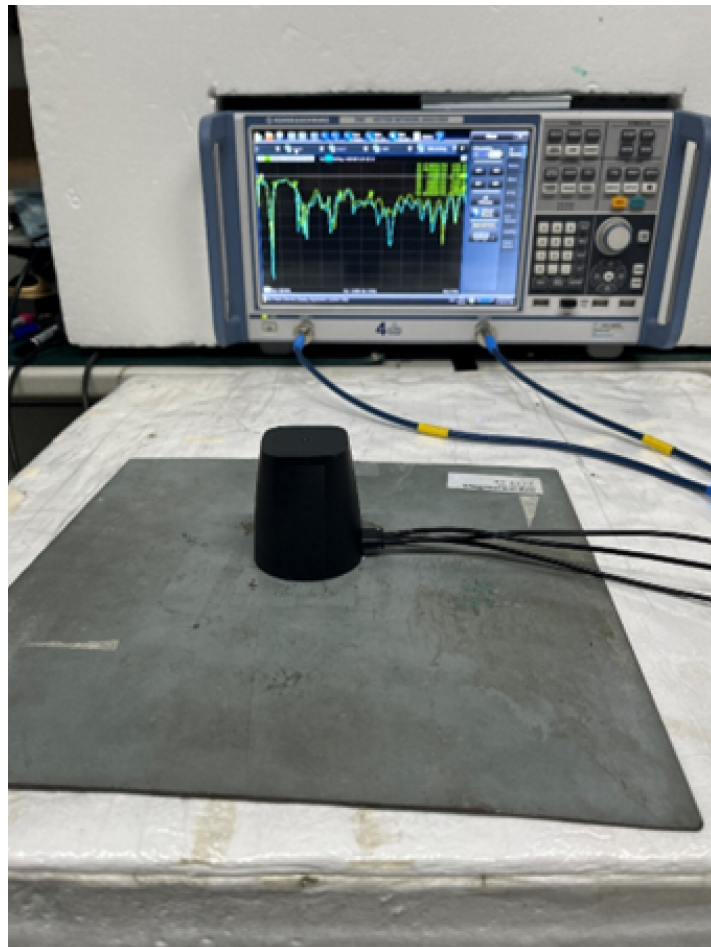

## 5.2 GNSS - Return Loss

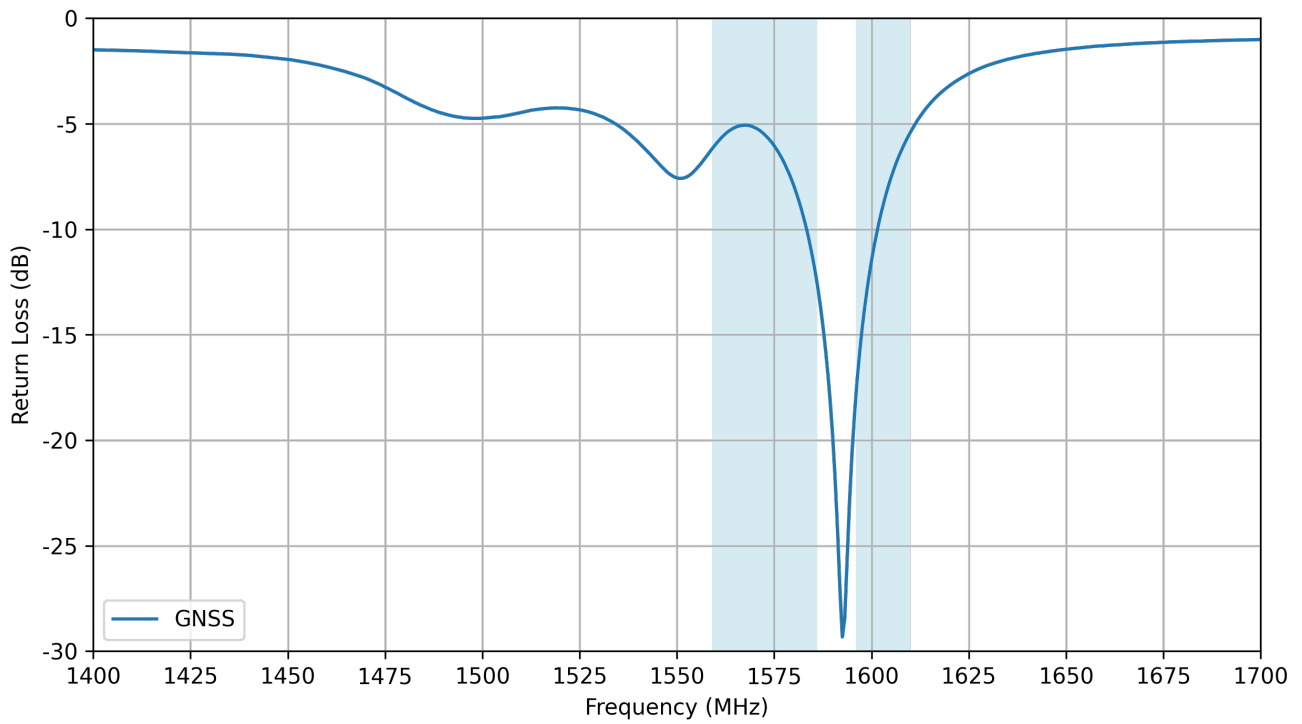

## 5.3 GNSS - VSWR

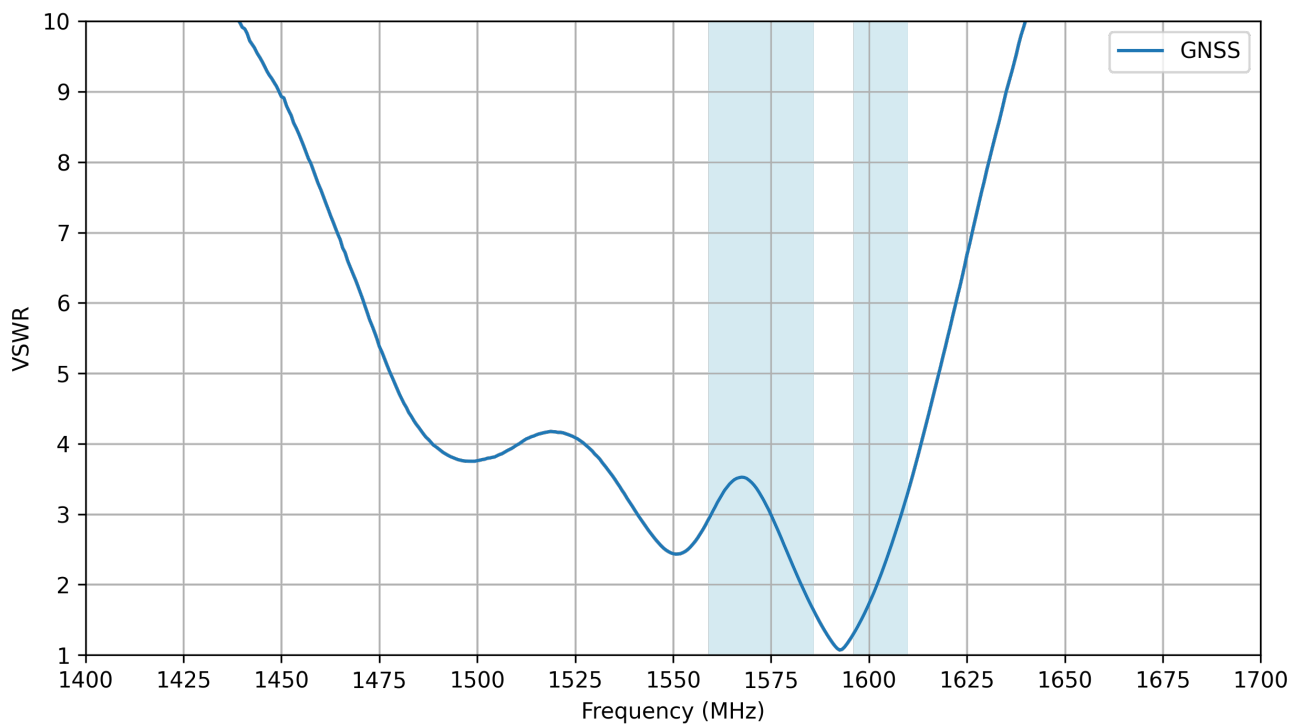

## 5.4 GNSS - Efficiency

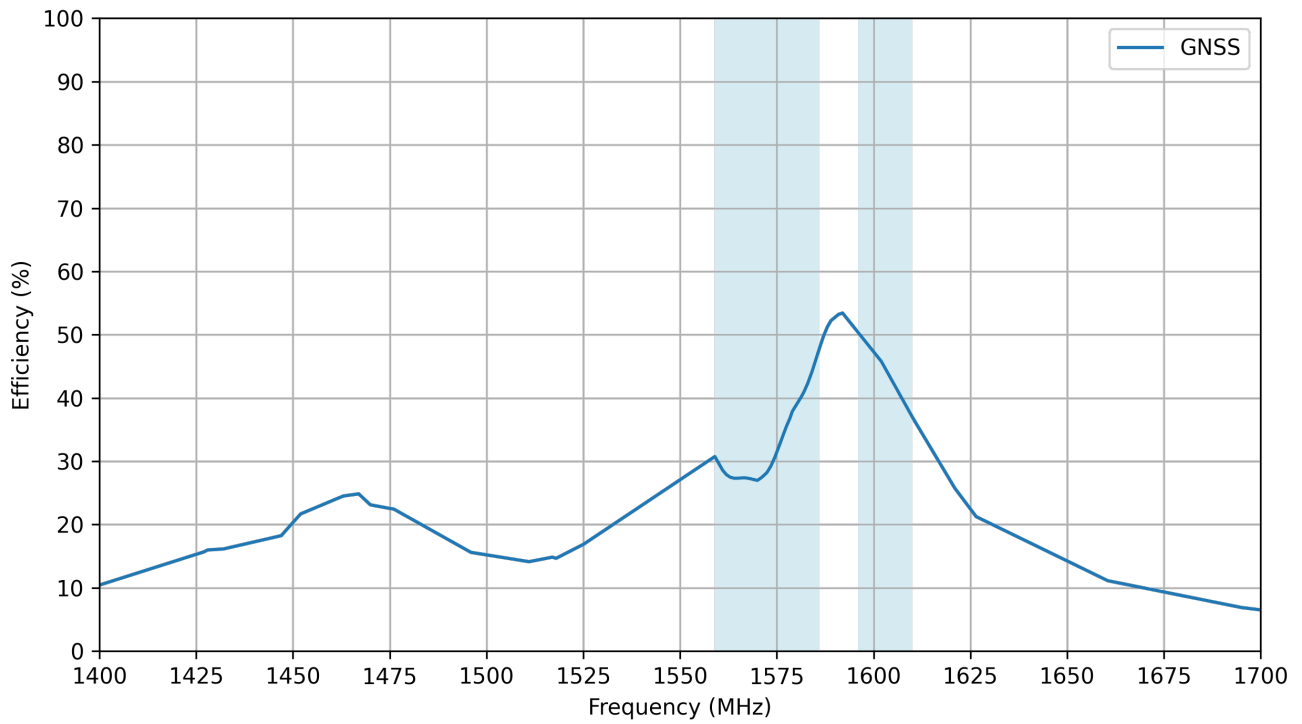

## 5.5 GNSS - Average Gain

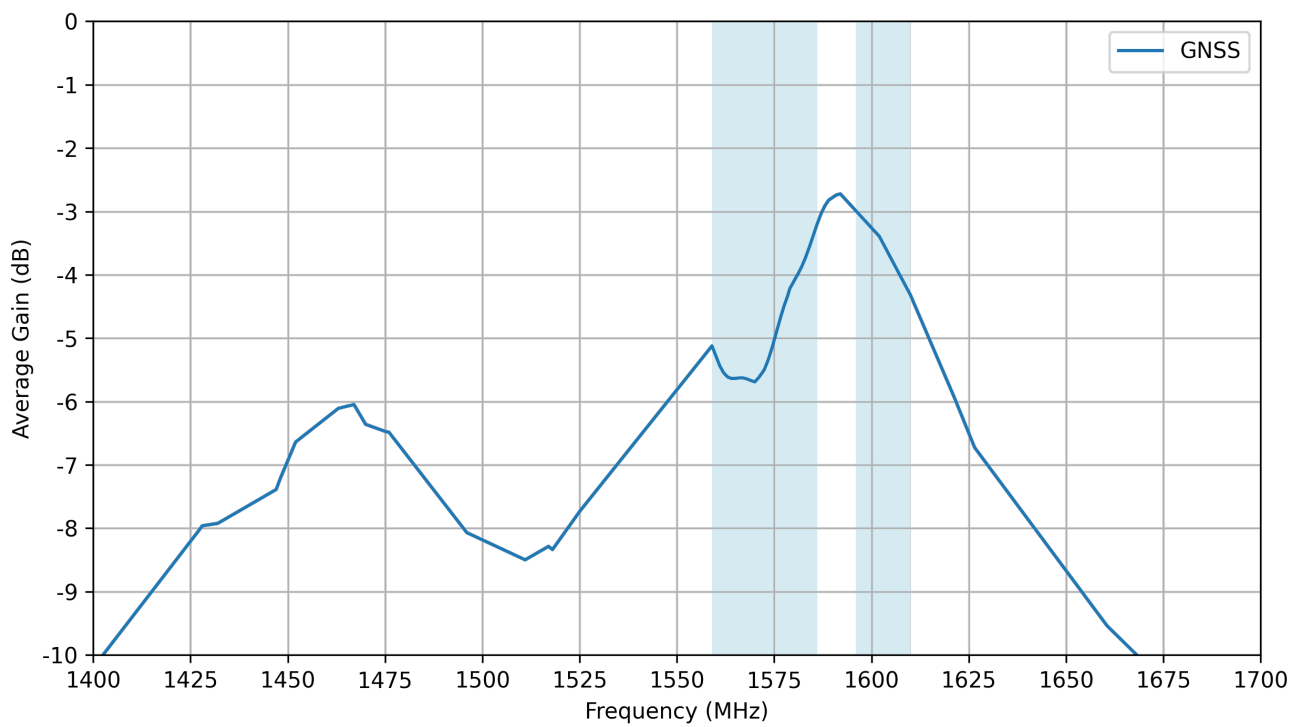

## 5.6 GNSS - Peak Gain (Gtotal)

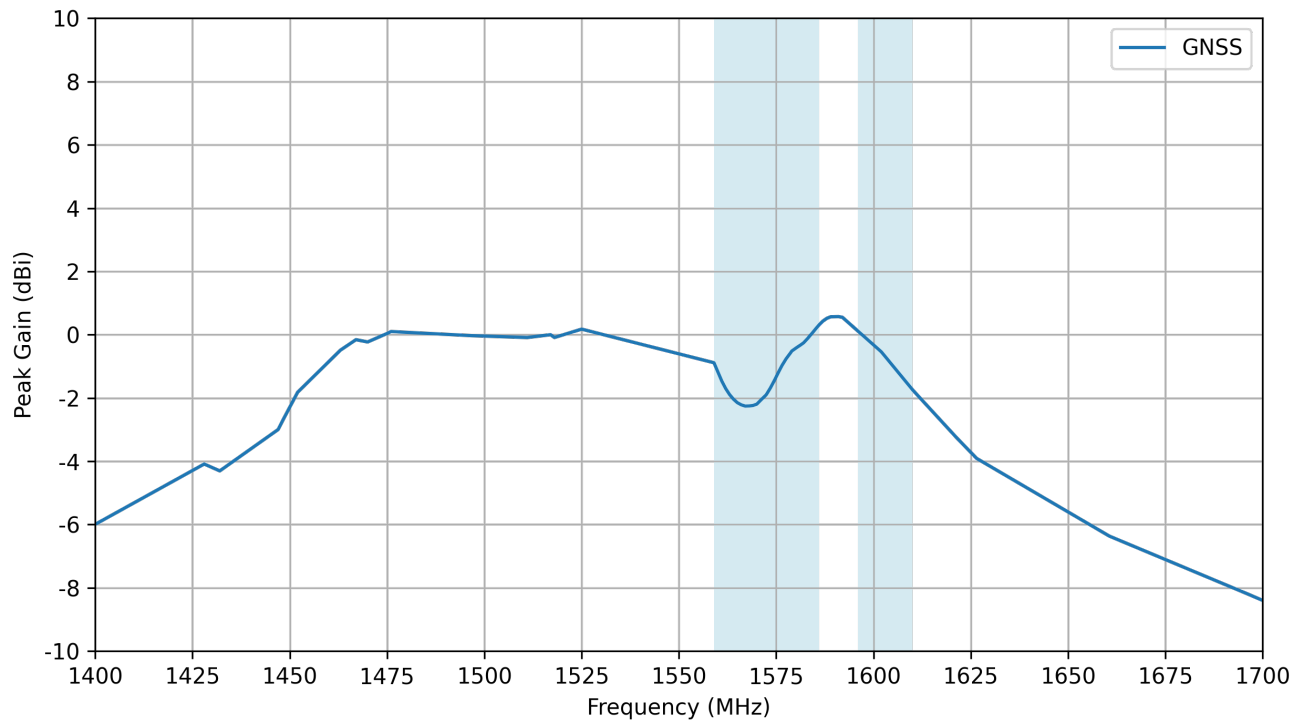

## 5.7 LTE - Return Loss

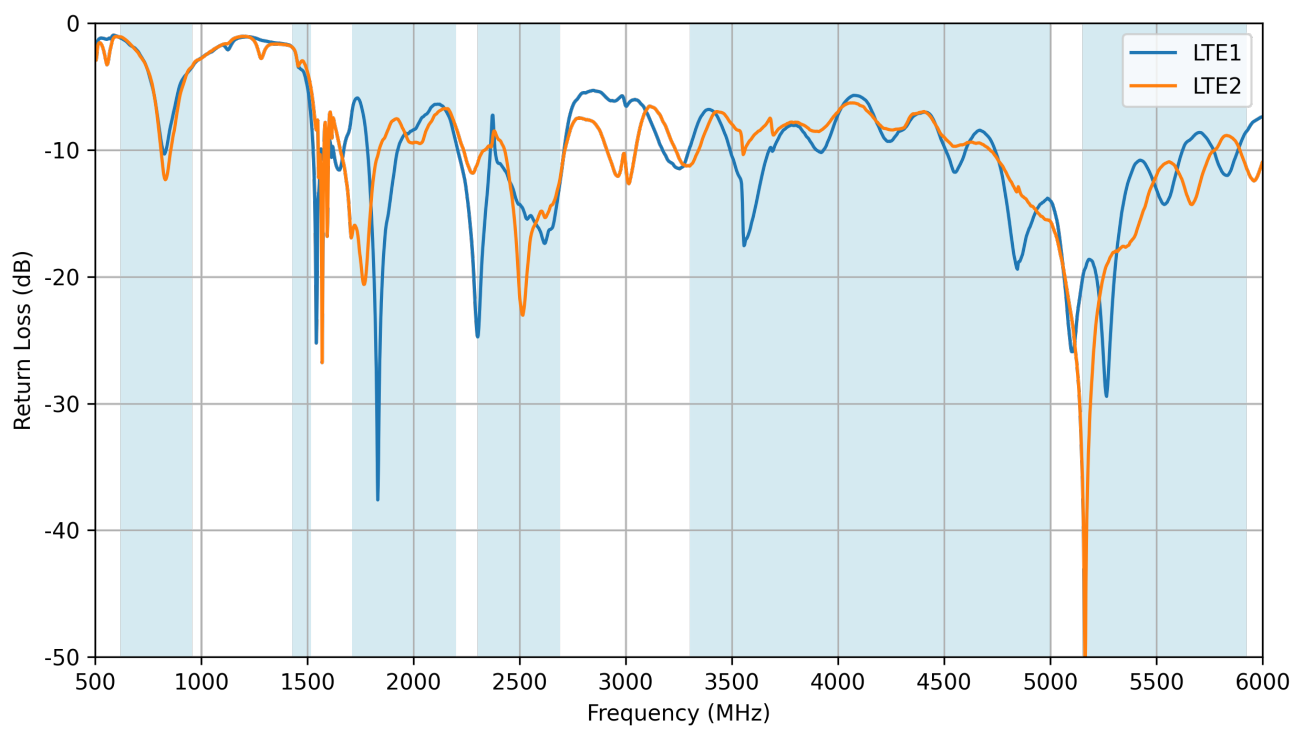

### 5.8 LTE - VSWR

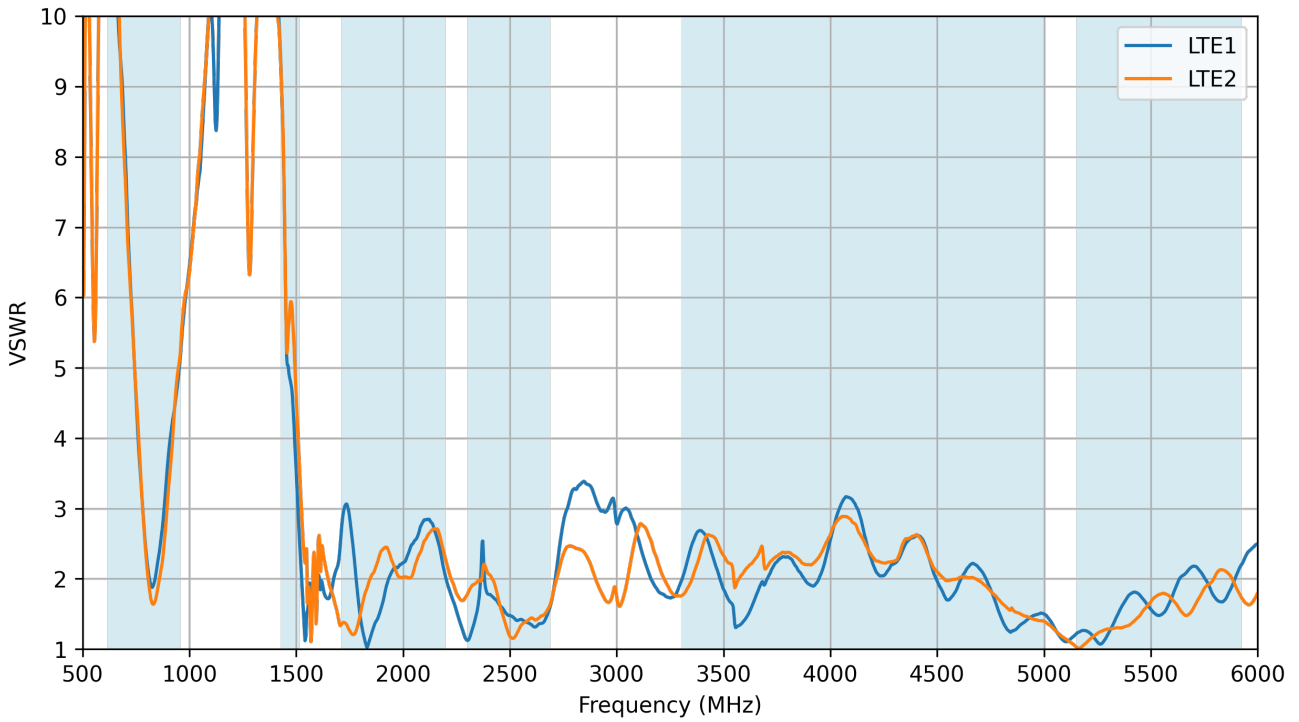

### 5.9 LTE - Efficiency

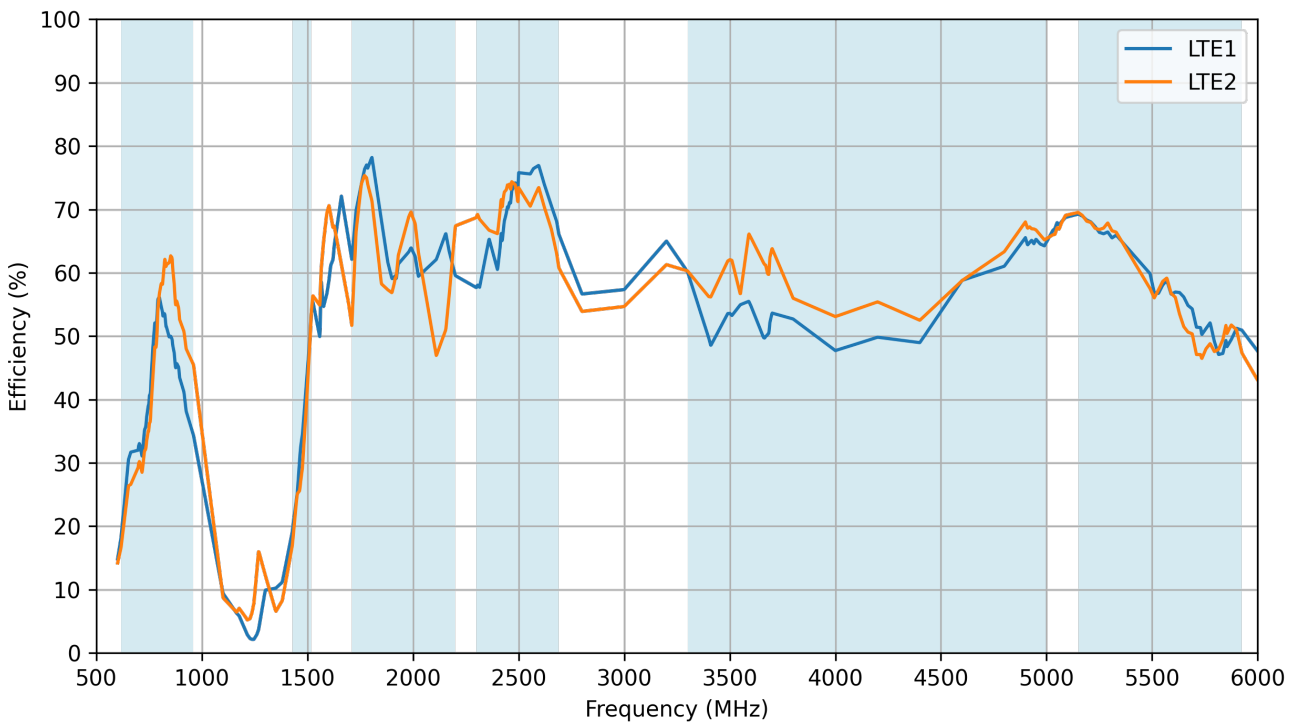

### 5.10 LTE - Average Gain

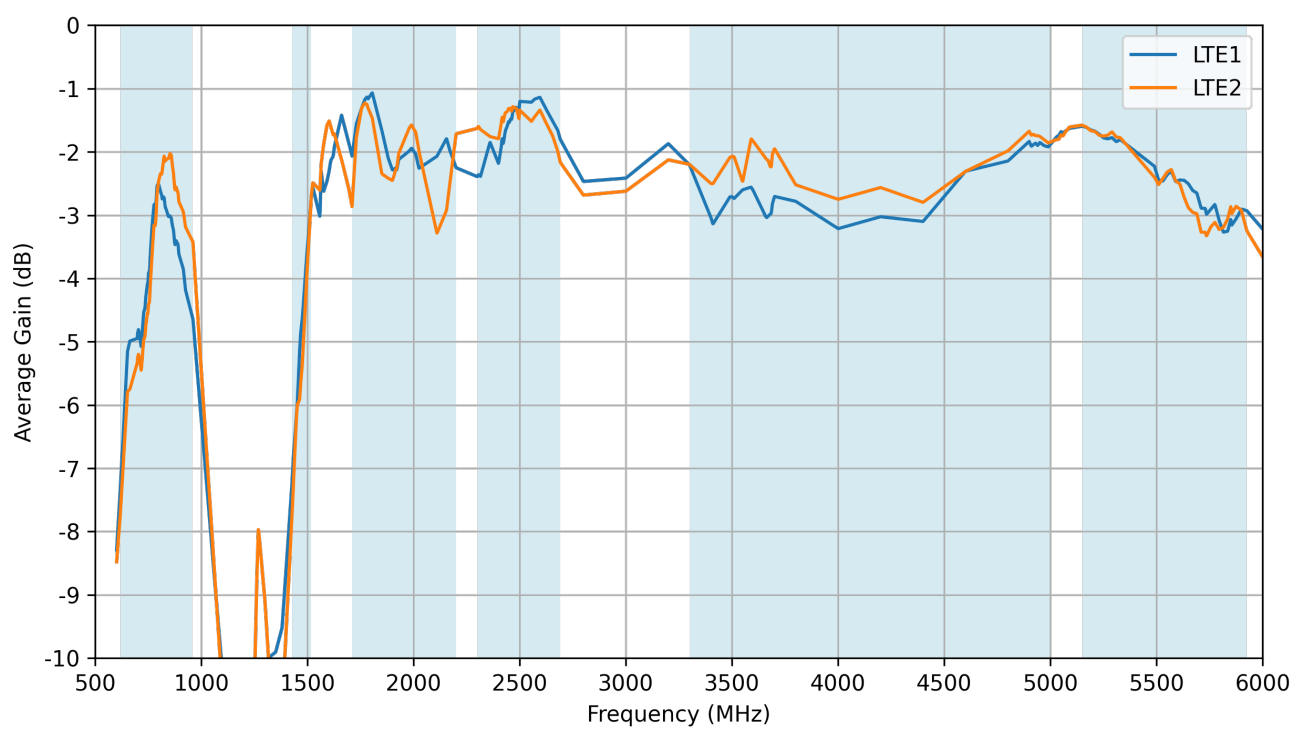

### 5.11 LTE - Peak Gain

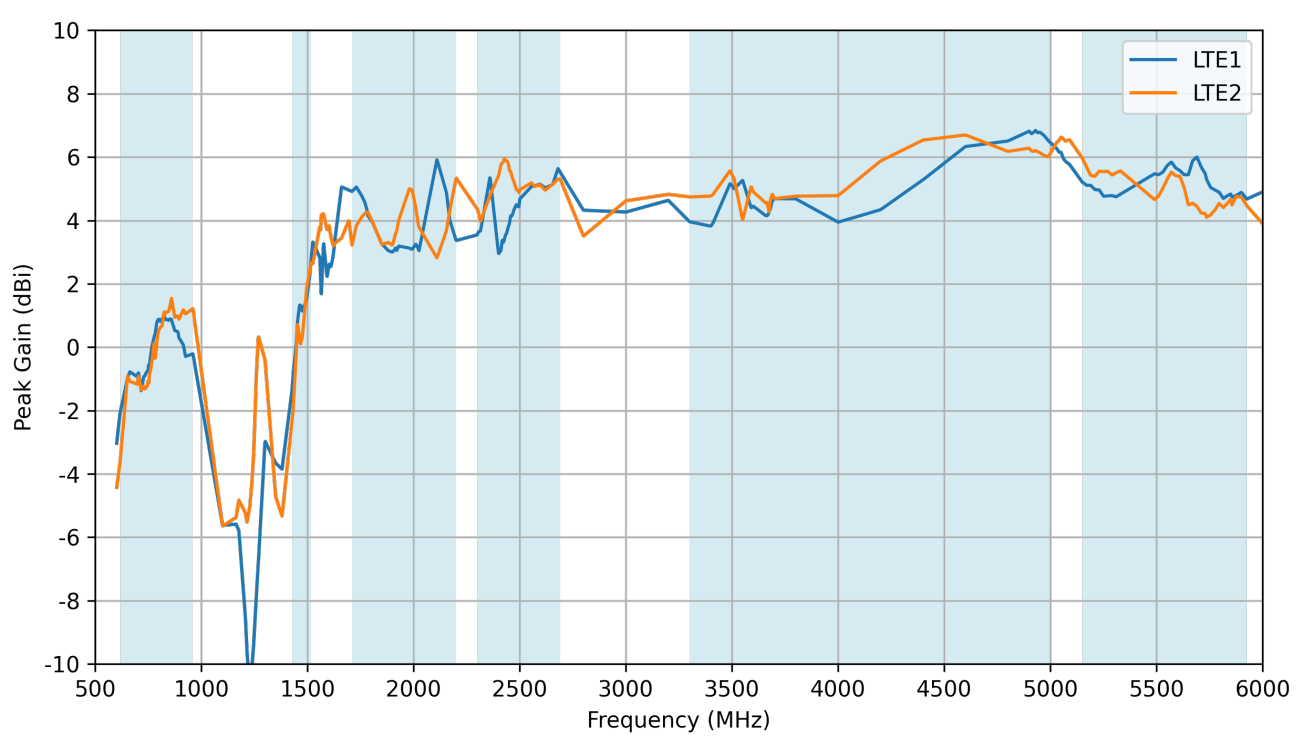

## 6. LNA Characteristics

### 6.1 Block Diagram

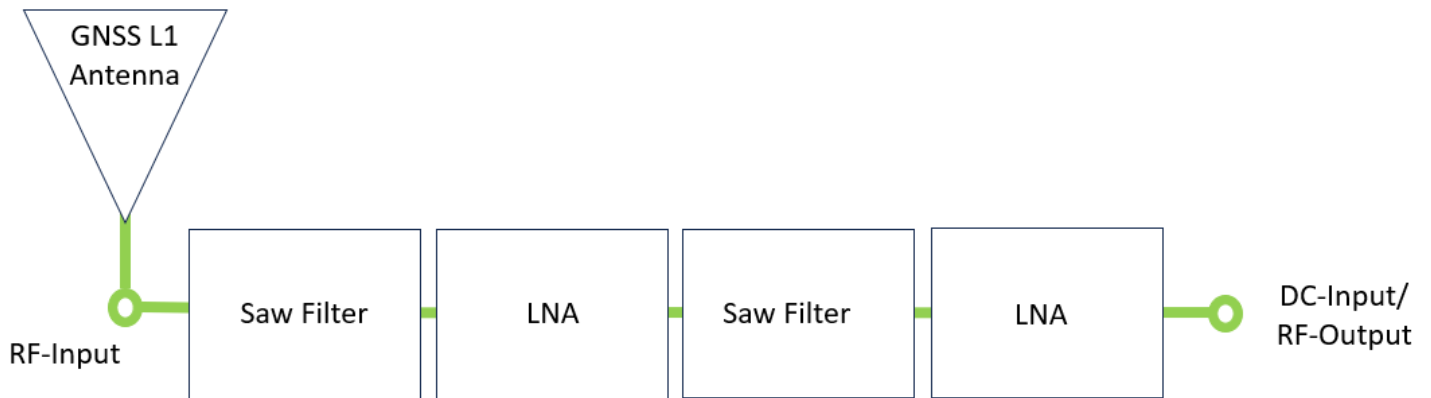

### 6.2 Gain

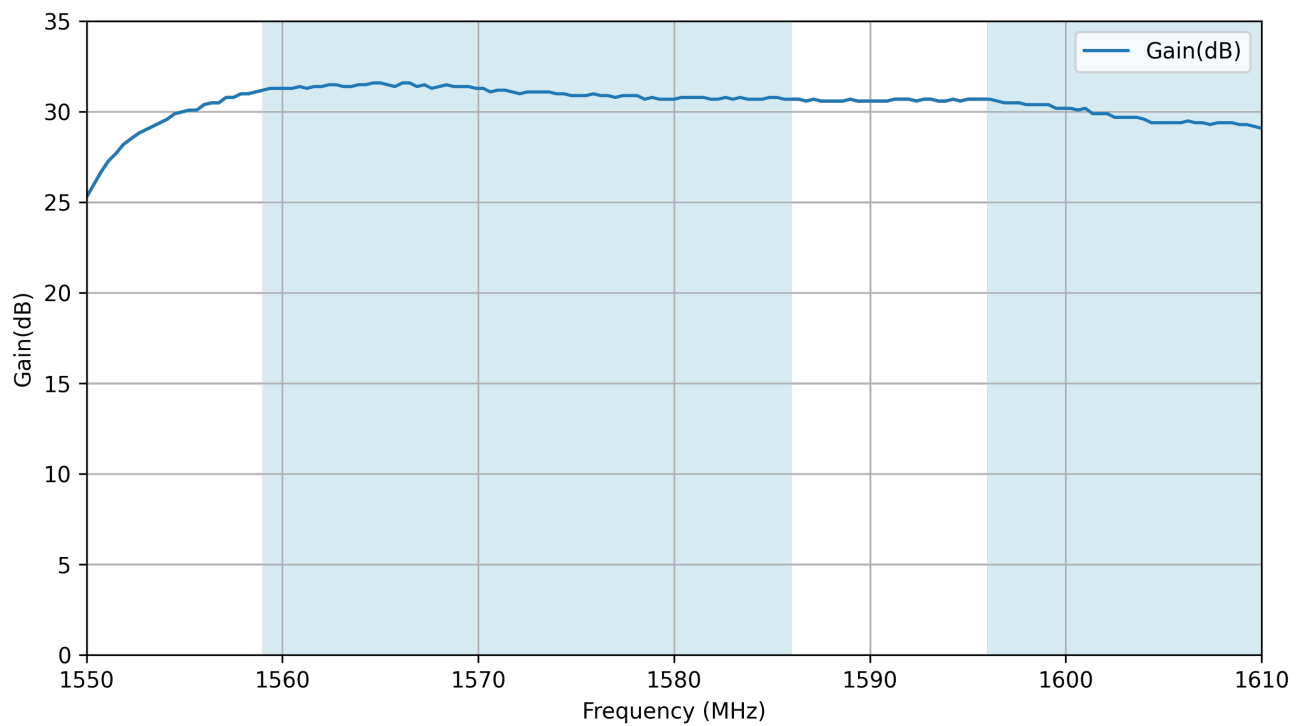

### 6.3 Noise Figure

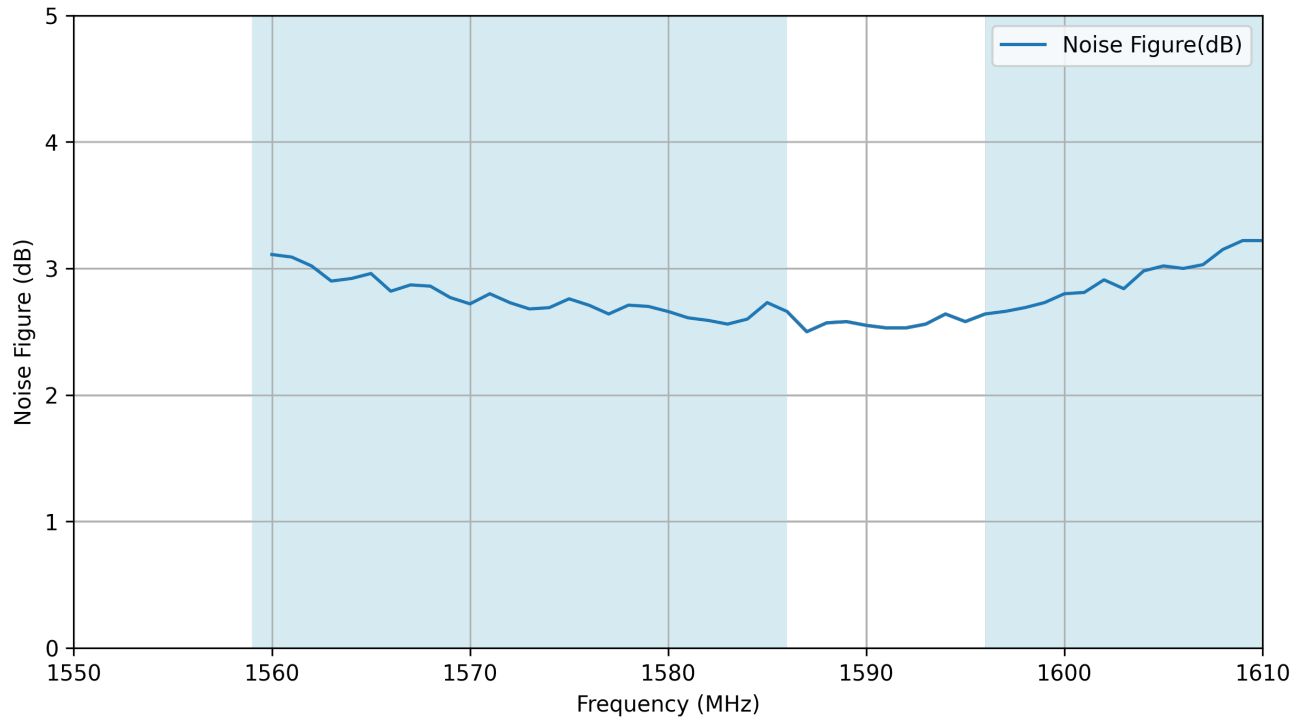

### 6.4 Wide Band Gain

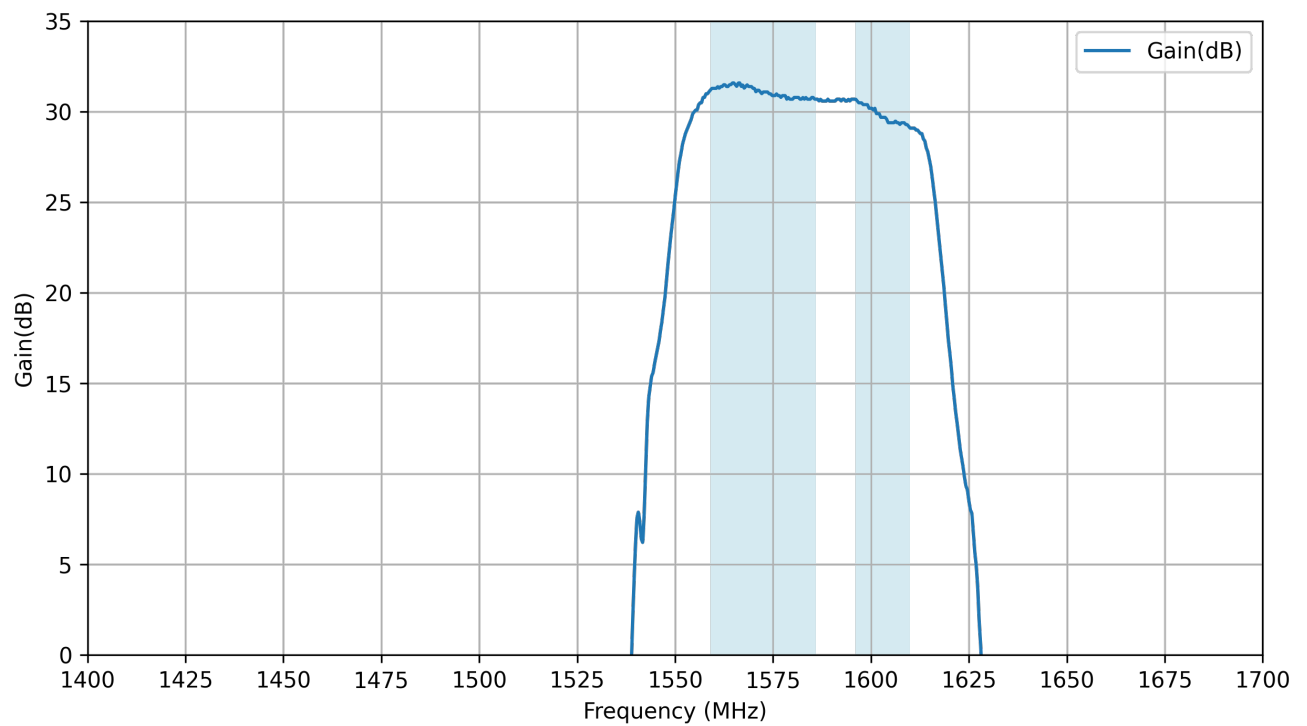



## 6.5 Out Of Band Rejection

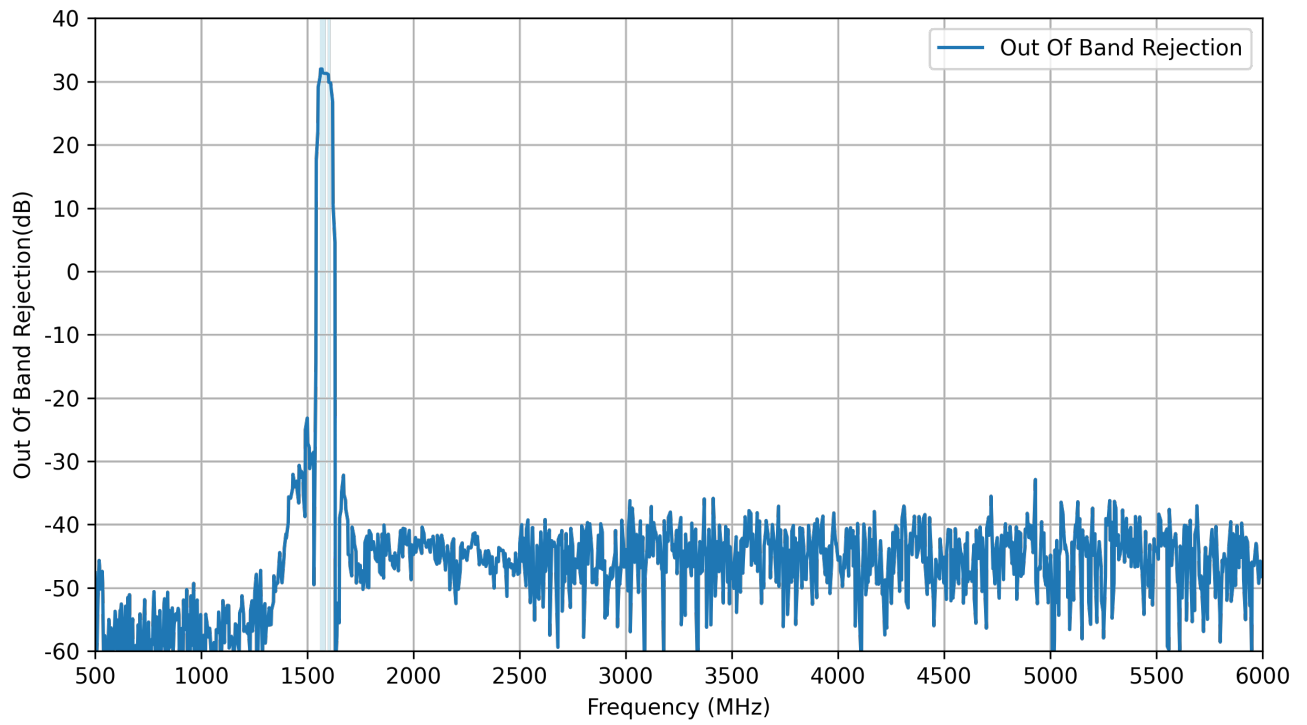

## 6.6 Group Delay

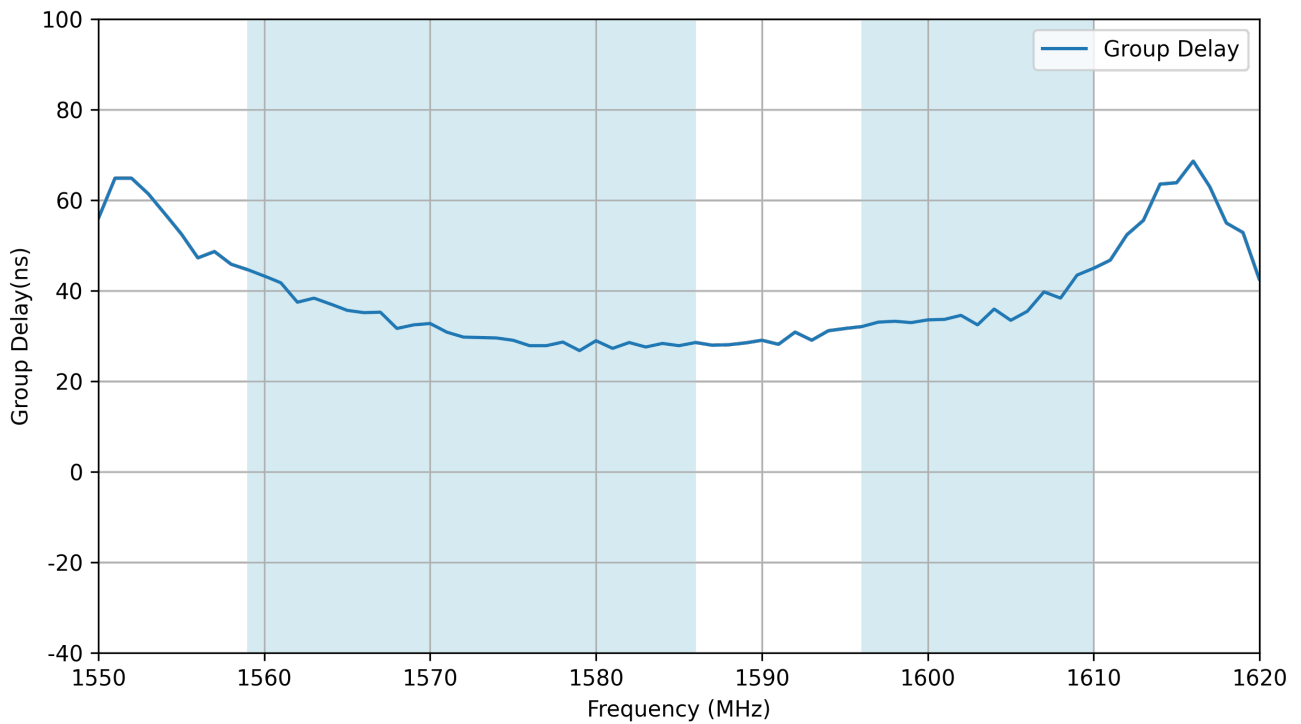

# 7. Radiation Patterns

## 7.1 Test Setup

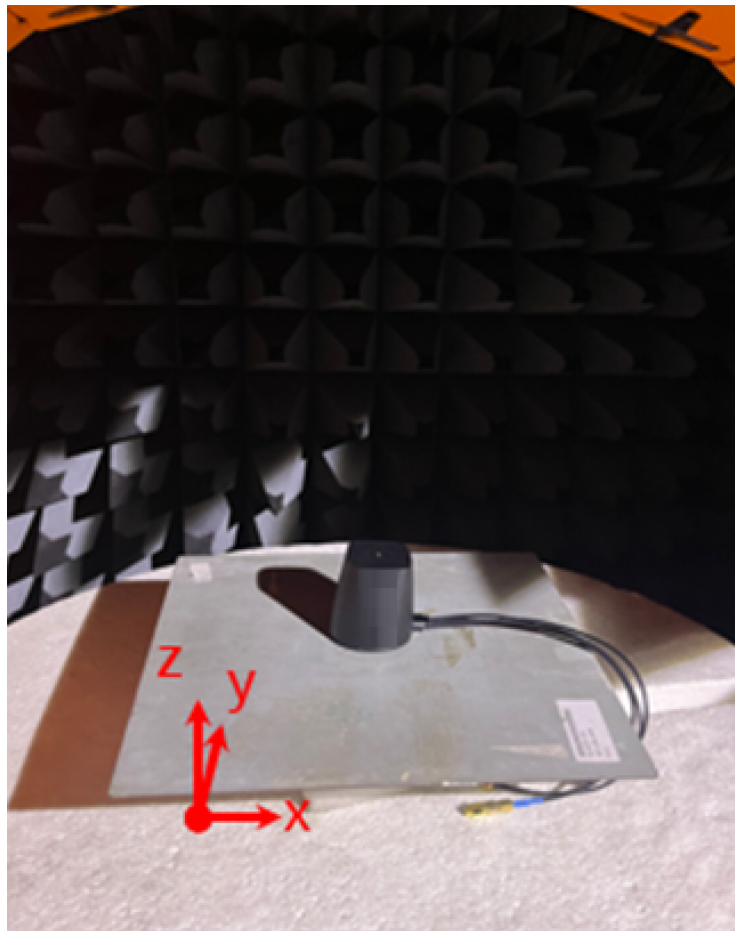
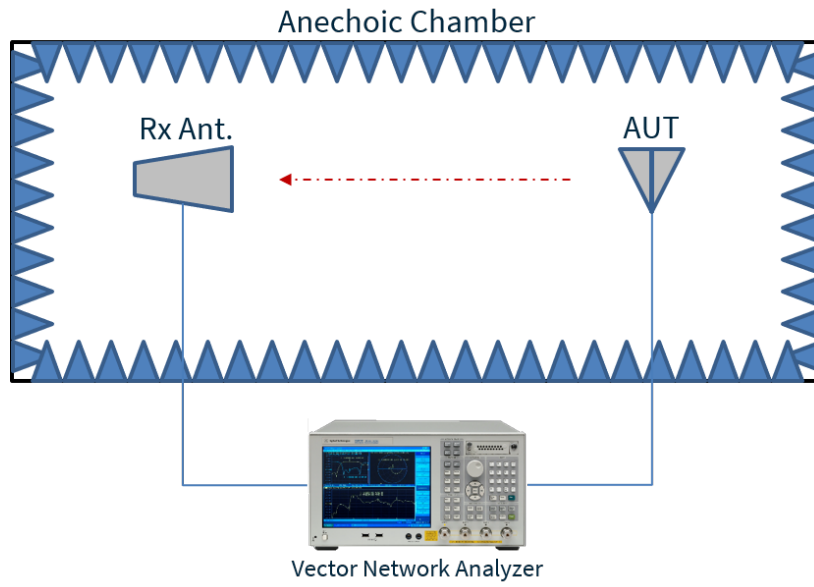

Chamber Set-up on 30x30cm Ground Plane

7.2 GNSS Patterns at 1576 MHz

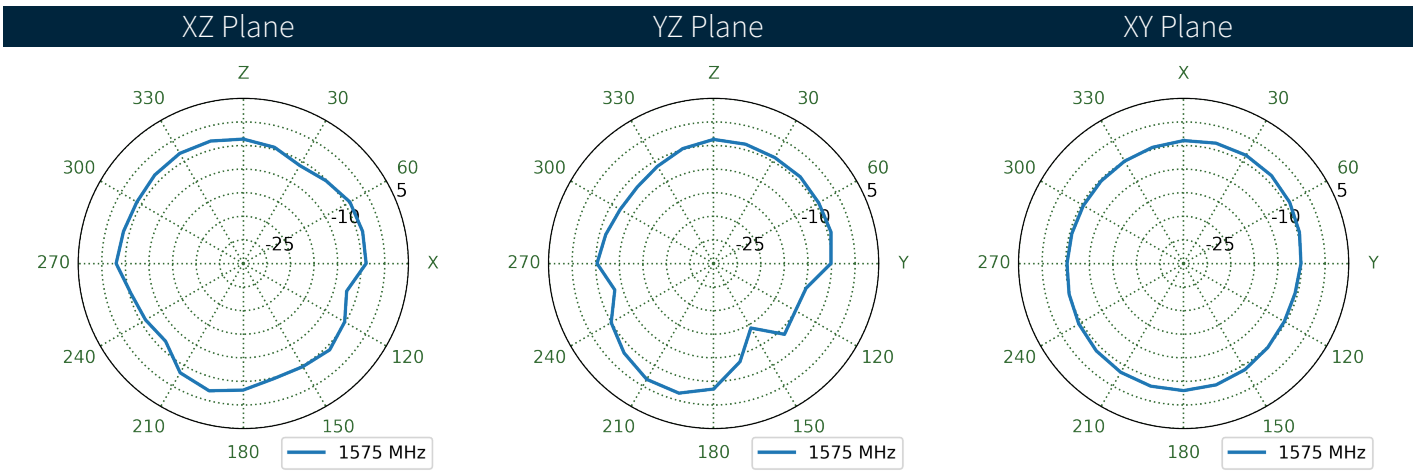
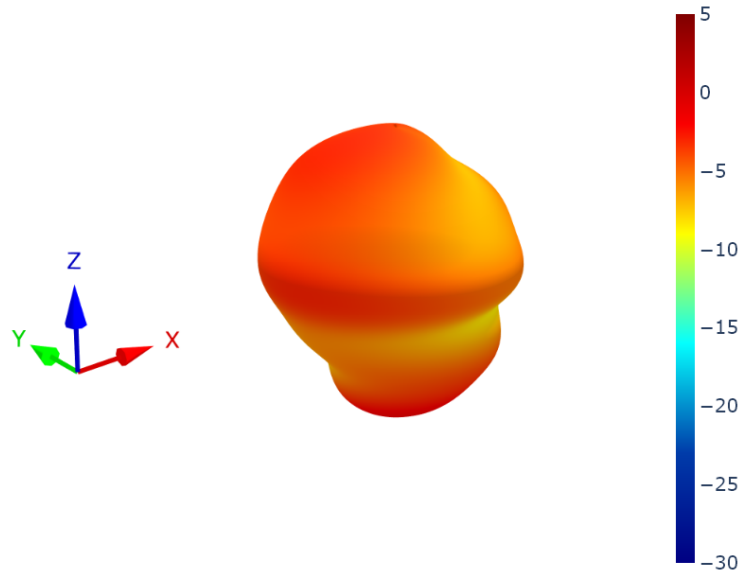

## 7.3 GNSS Patterns at 1562 MHz

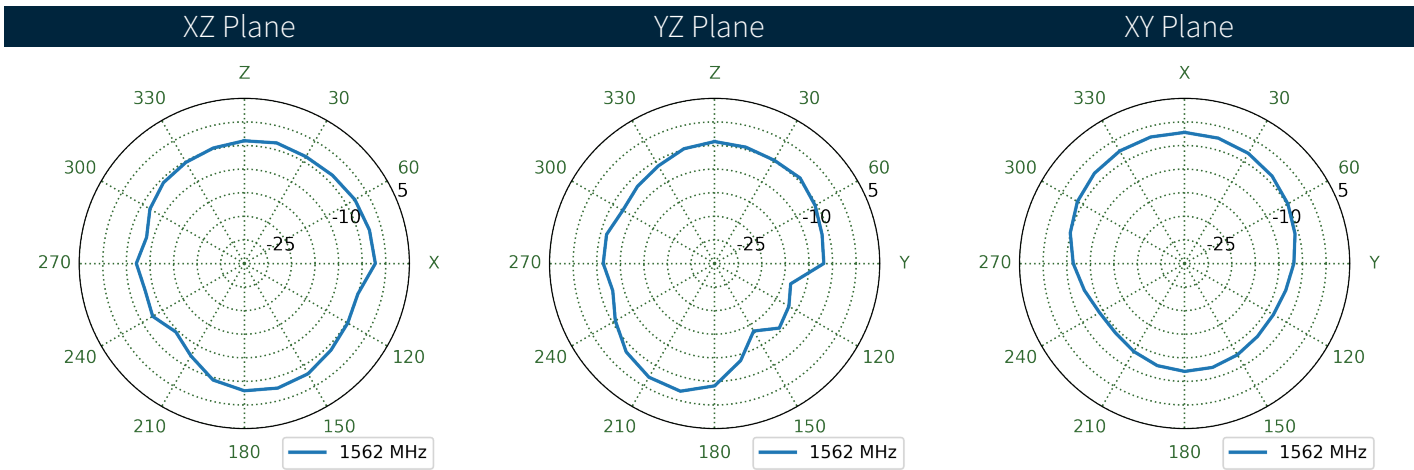
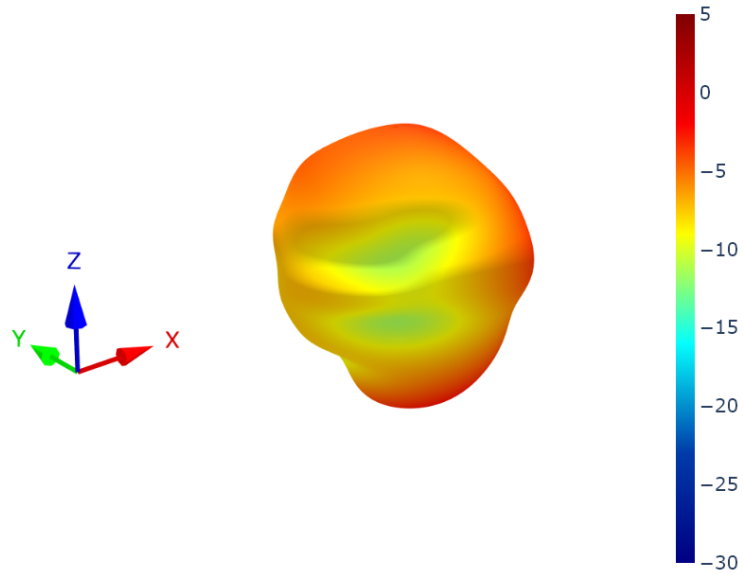

7.4 GNSS Patterns at 1602 MHz

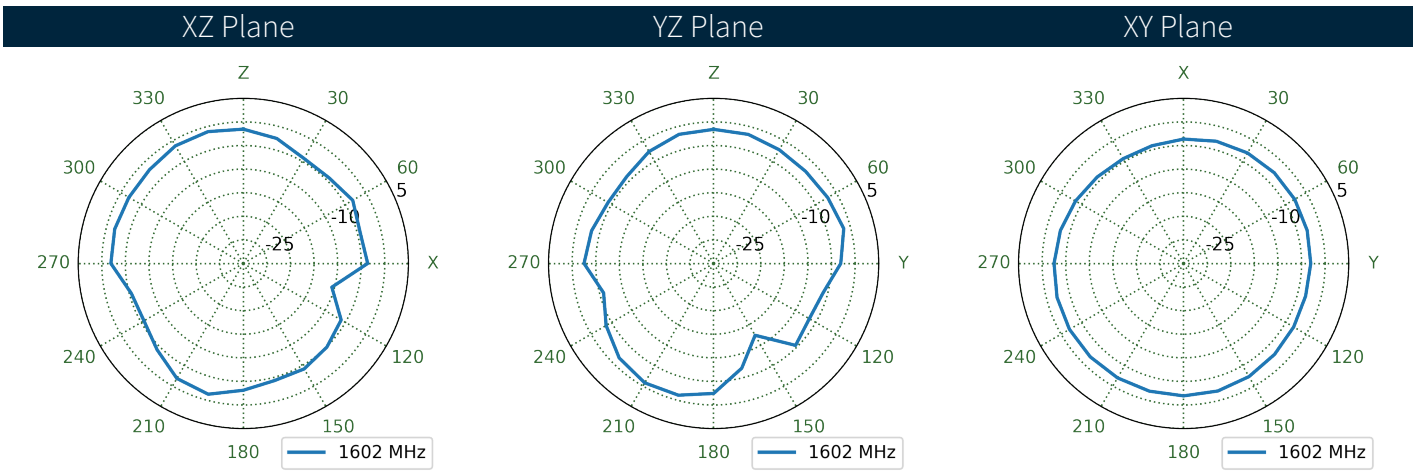
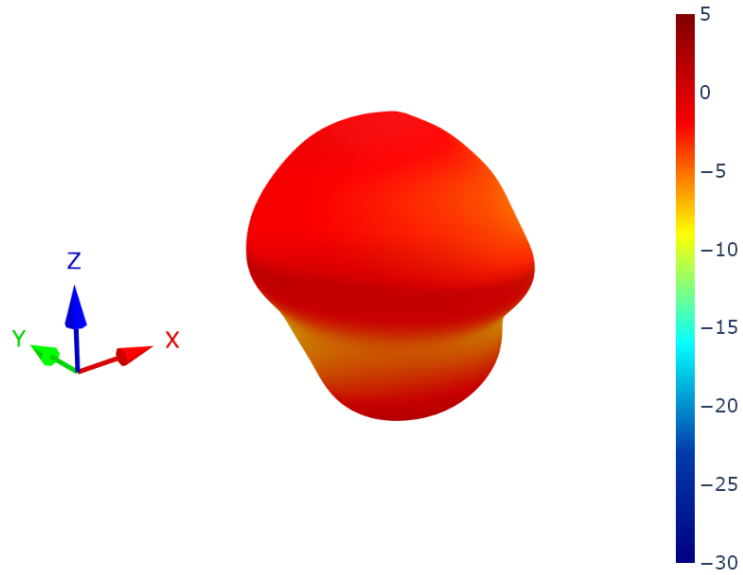

7.5 LTE1 Patterns at 650 MHz

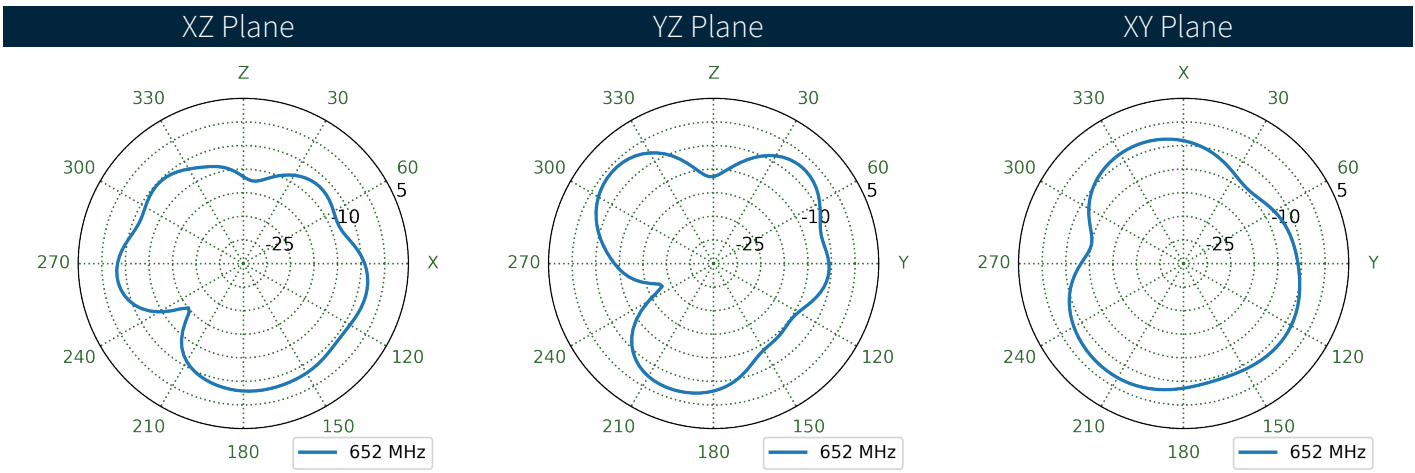
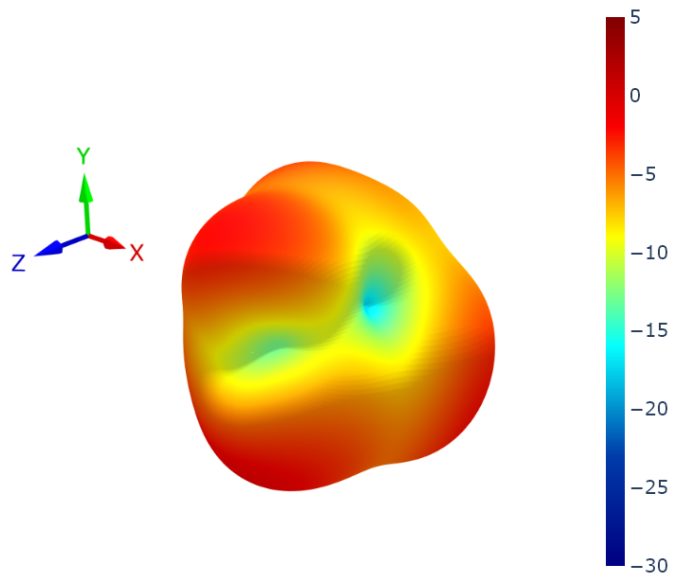

7.6 LTE2 Patterns at 650 MHz

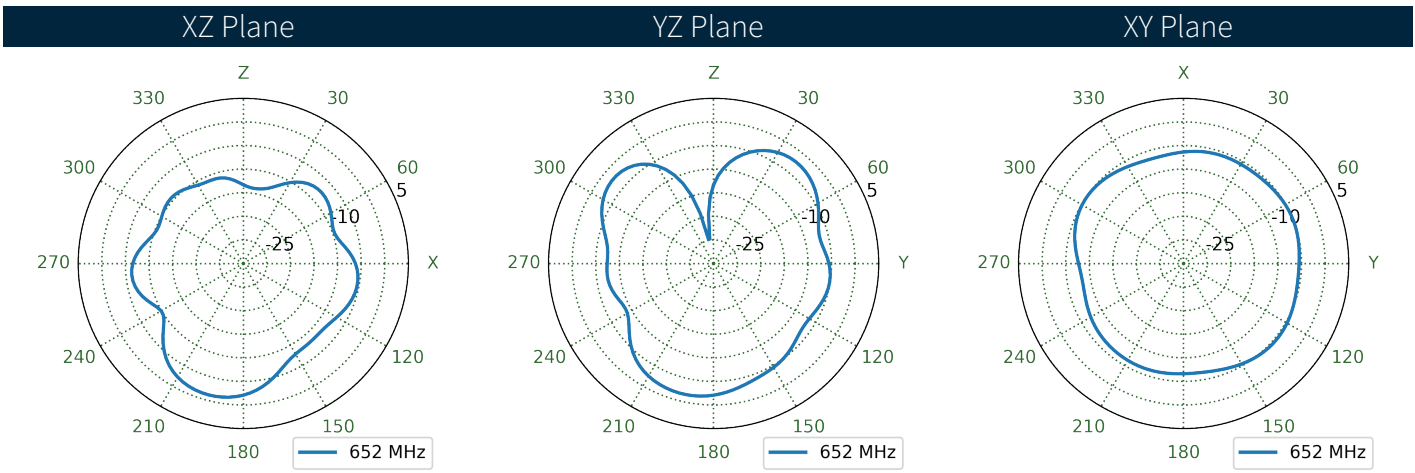
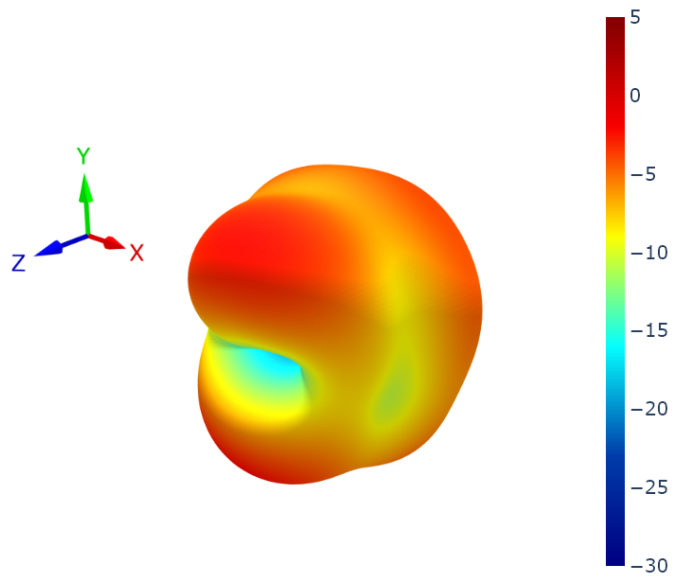

7.7 LTE1 Patterns at 750 MHz

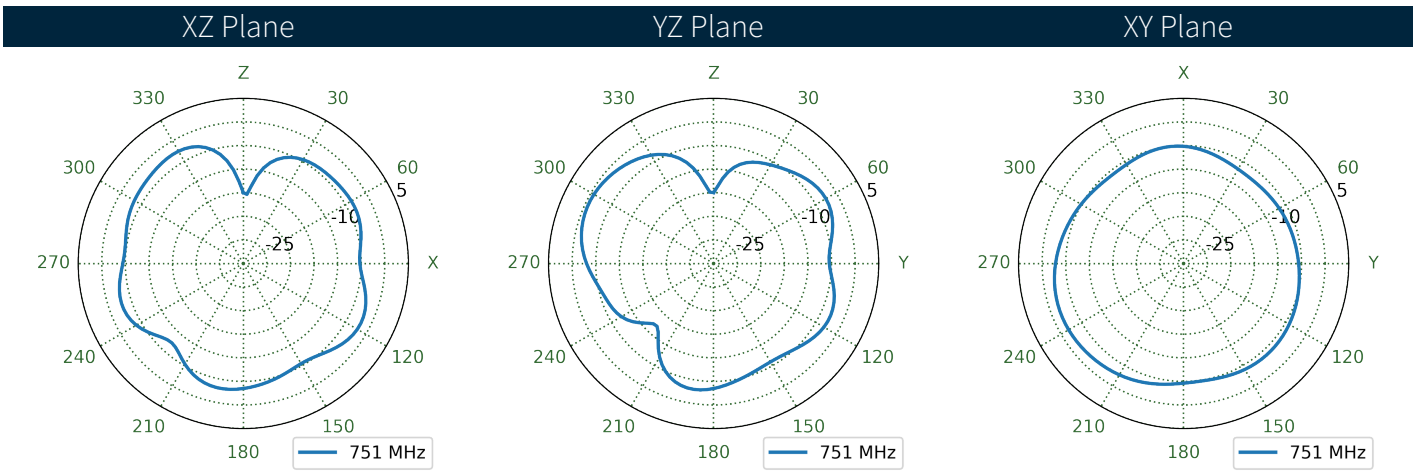
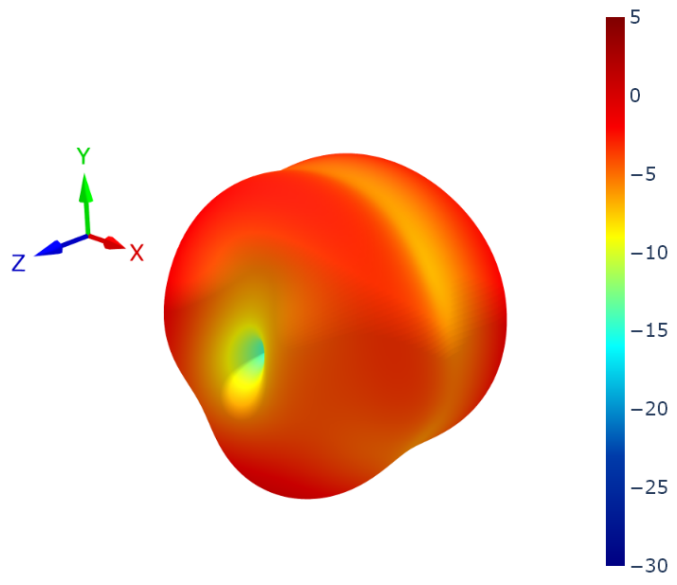



7.8 LTE2 Patterns at 750 MHz

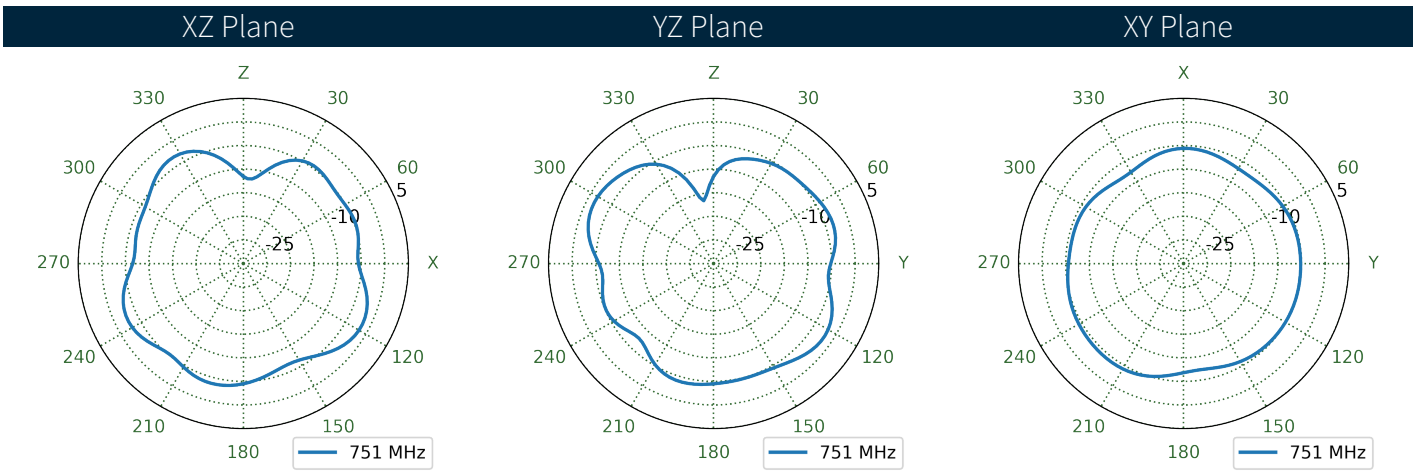
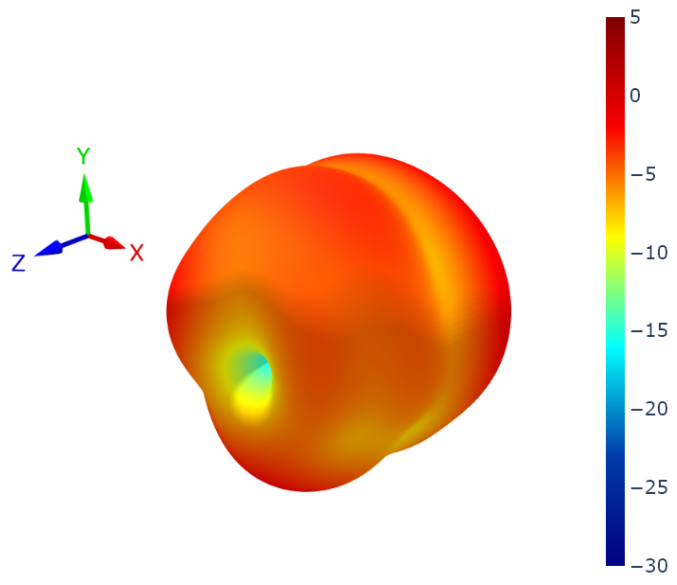

7.9 LTE1 Patterns at 890 MHz

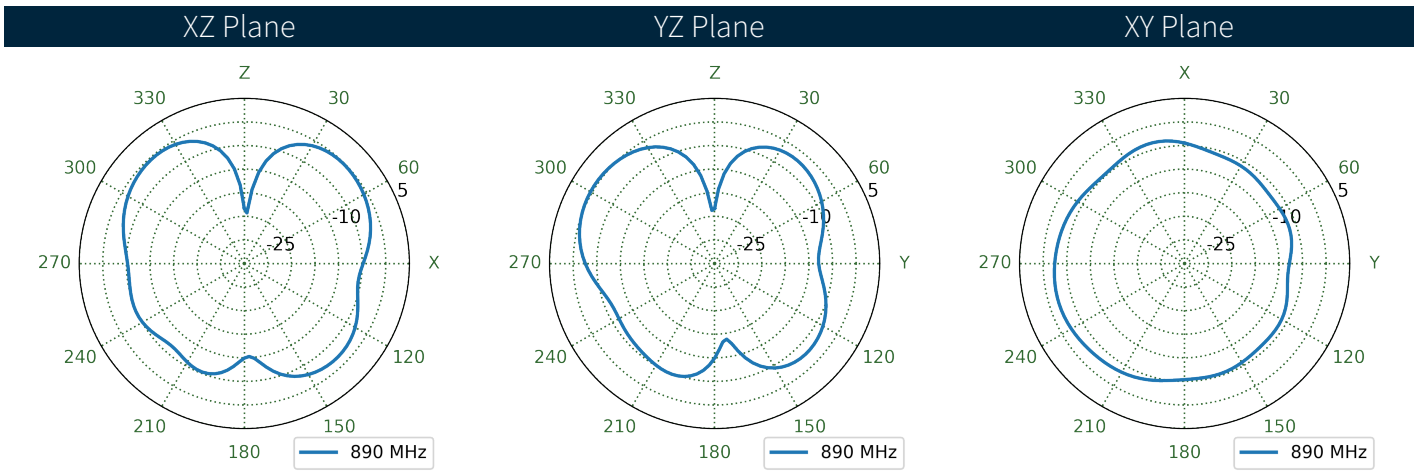
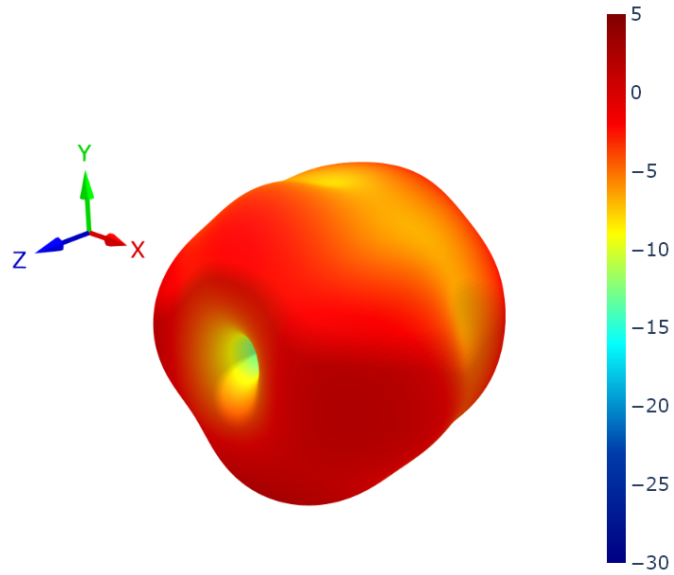

7.10 LTE2 Patterns at 890 MHz

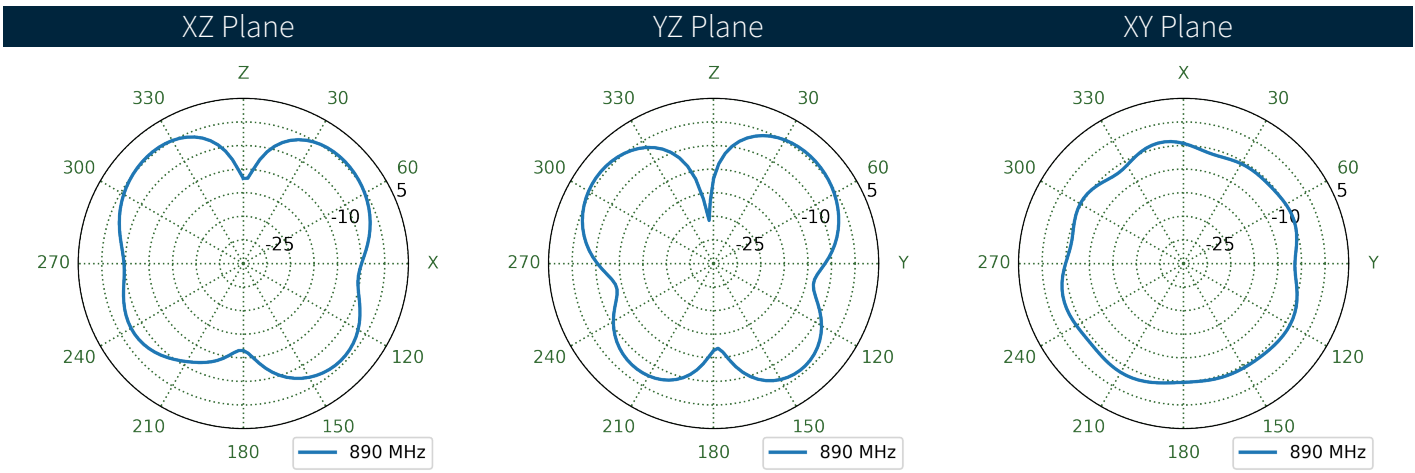
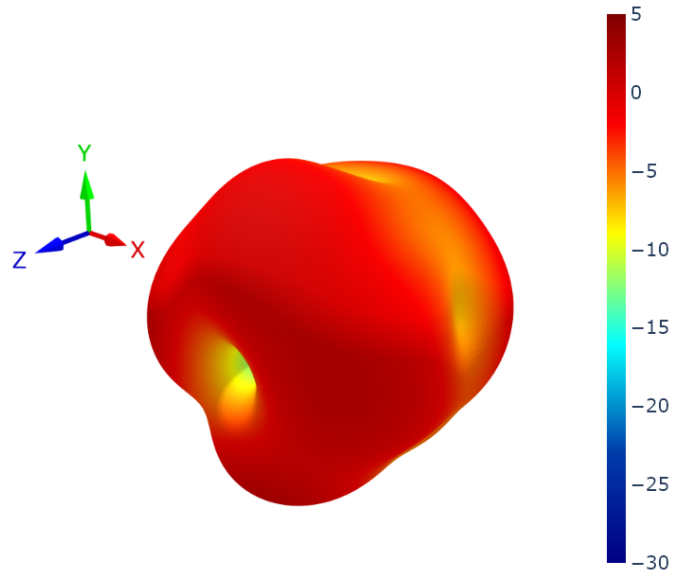

7.11 LTE1 Patterns at 1470 MHz

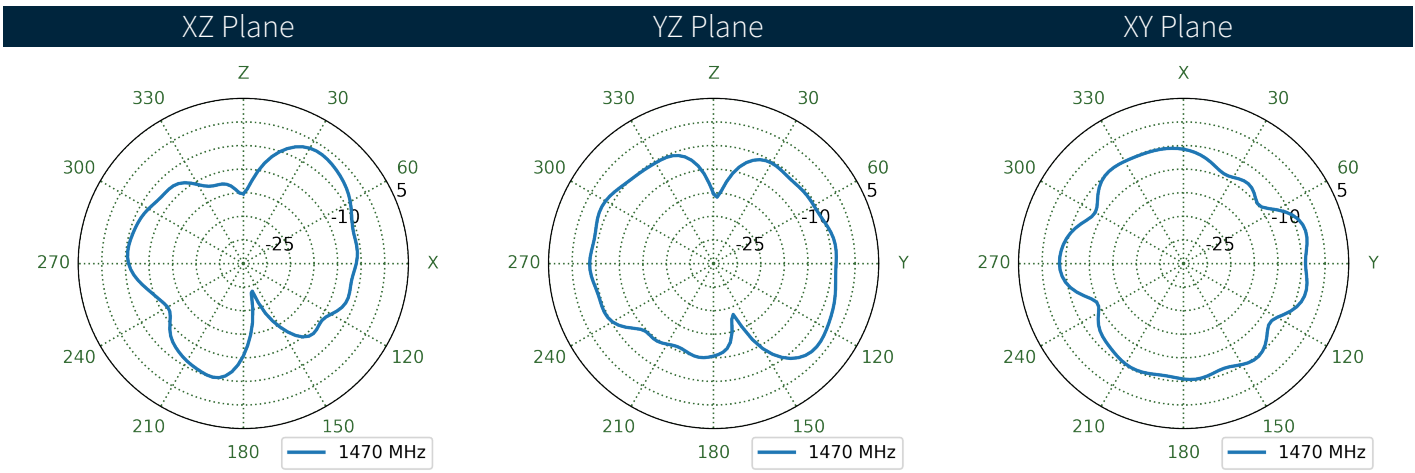
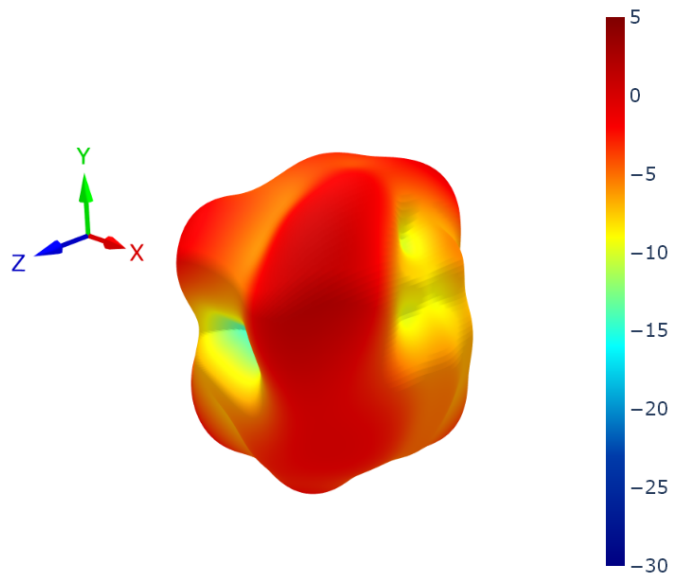

7.12 LTE2 Patterns at 1470 MHz

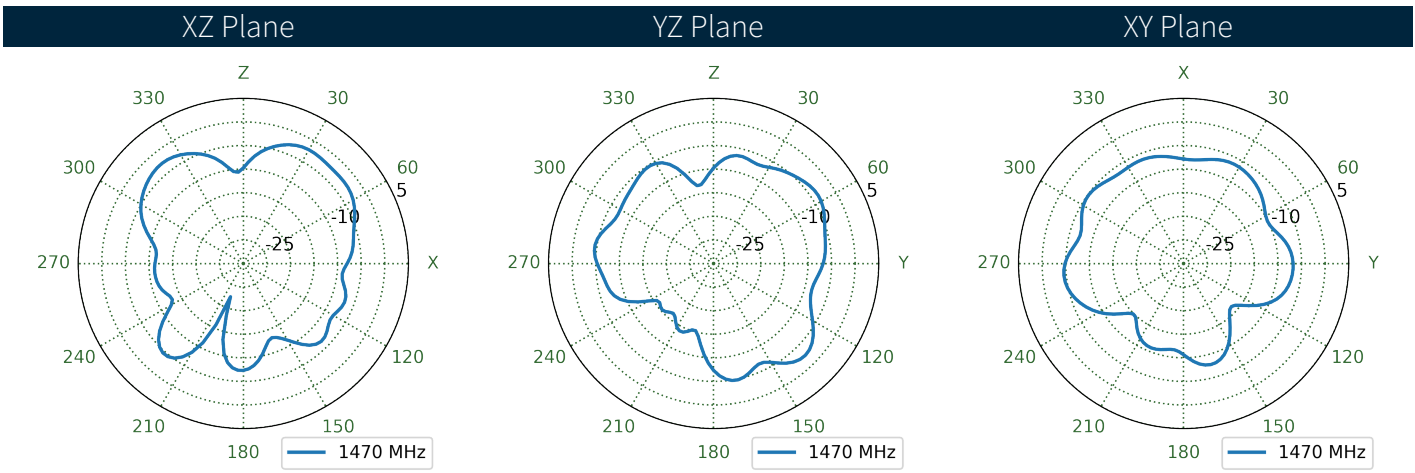
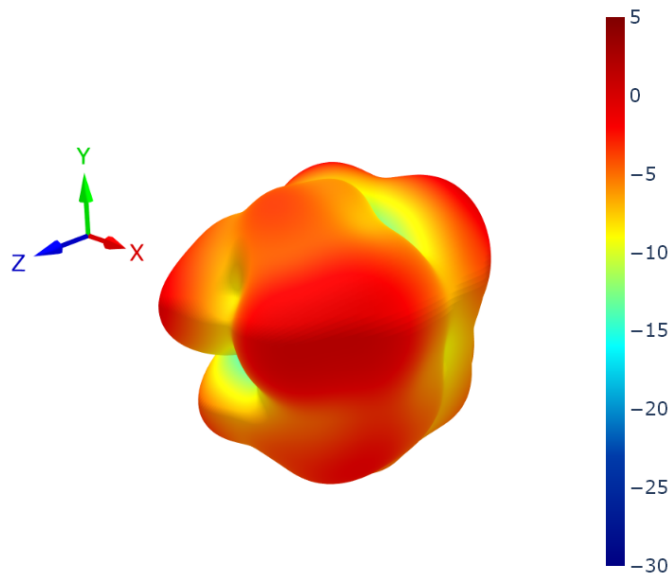

7.13 LTE1 Patterns at 1805 MHz

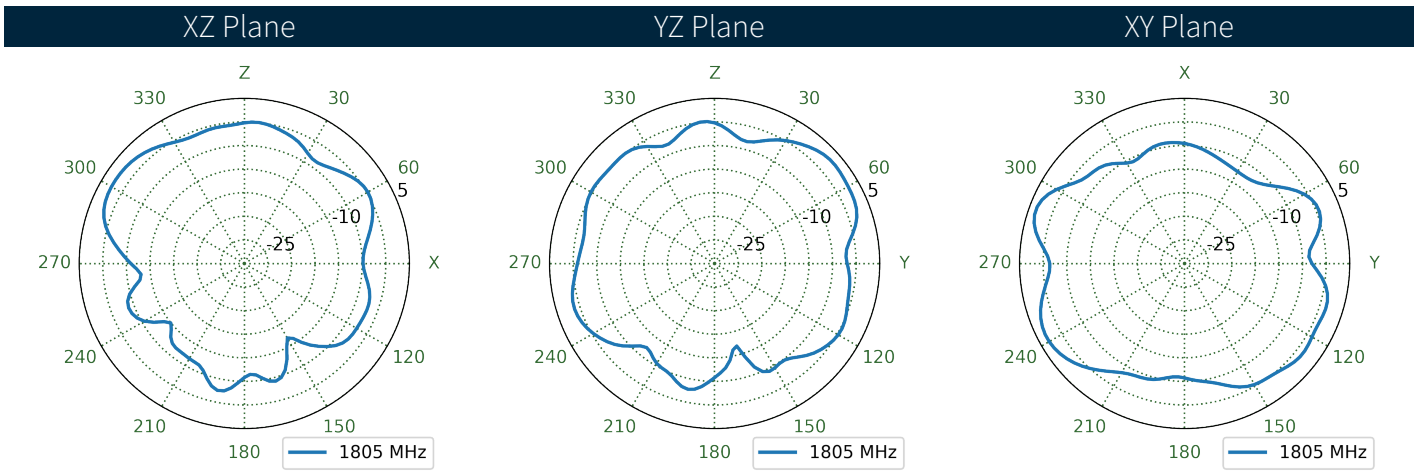
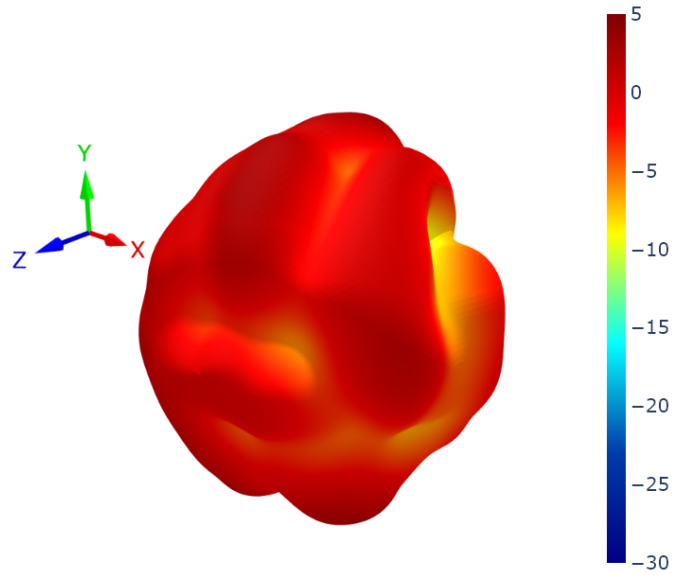

7.14 LTE2 Patterns at 1805 MHz

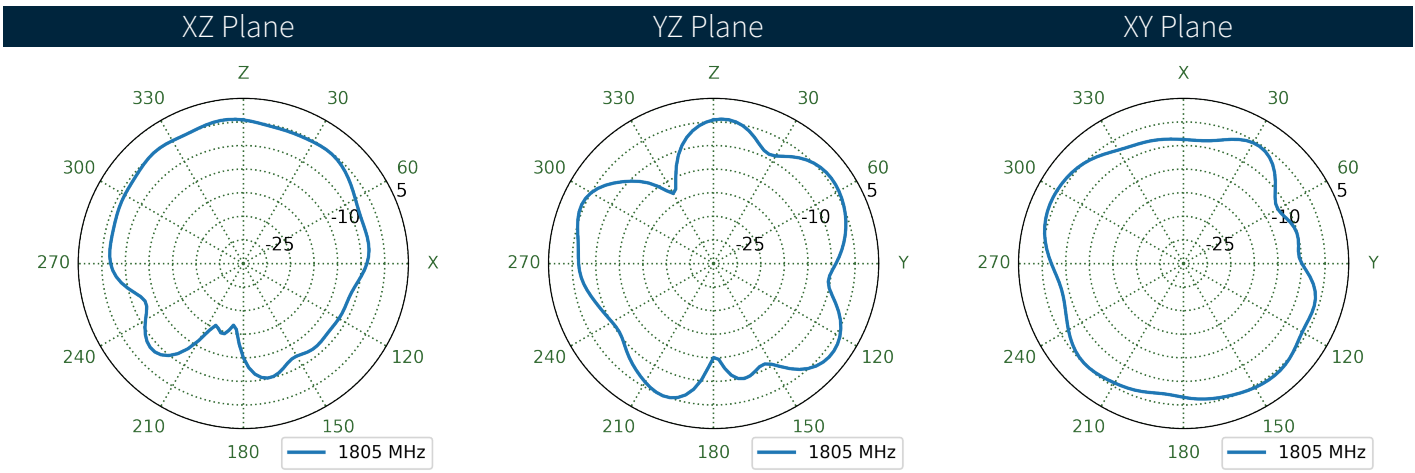
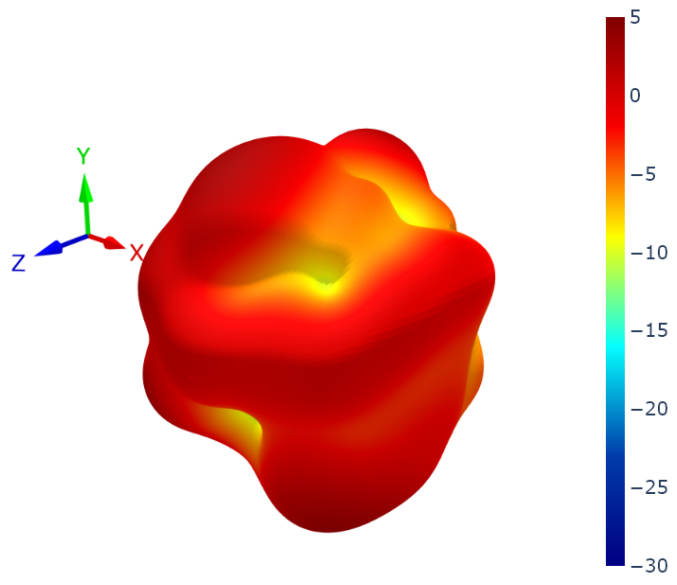

7.15 LTE1 Patterns at 1920 MHz

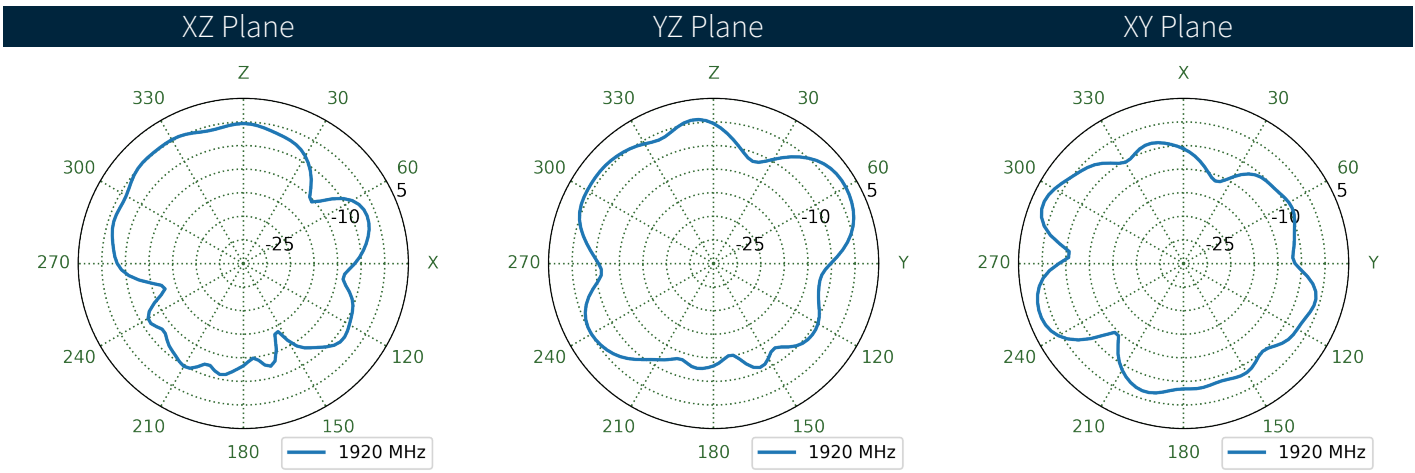
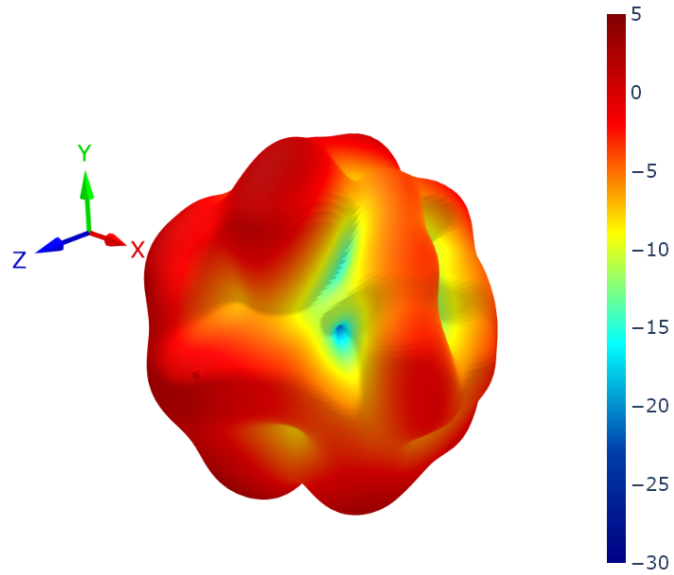



7.16 LTE2 Patterns at 1920 MHz

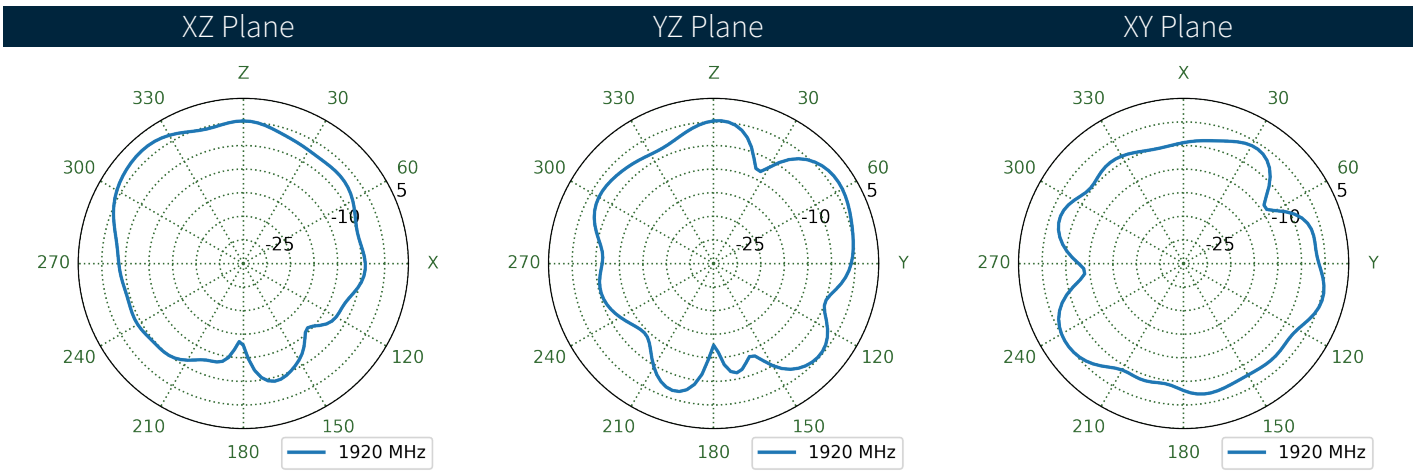
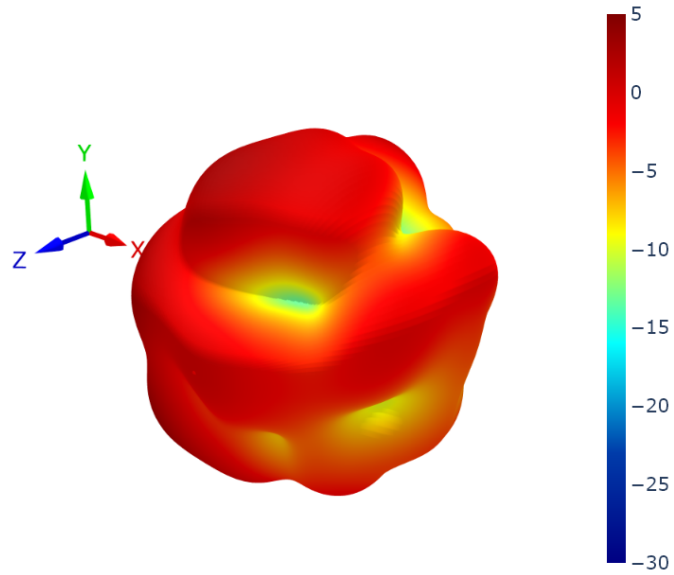

7.17 LTE1 Patterns at 1990 MHz

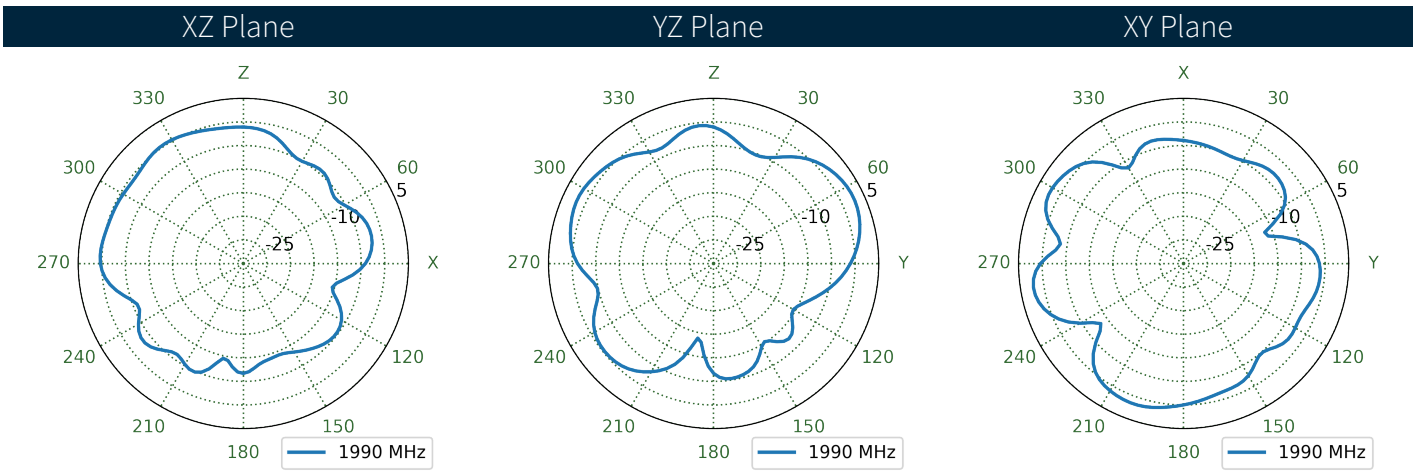
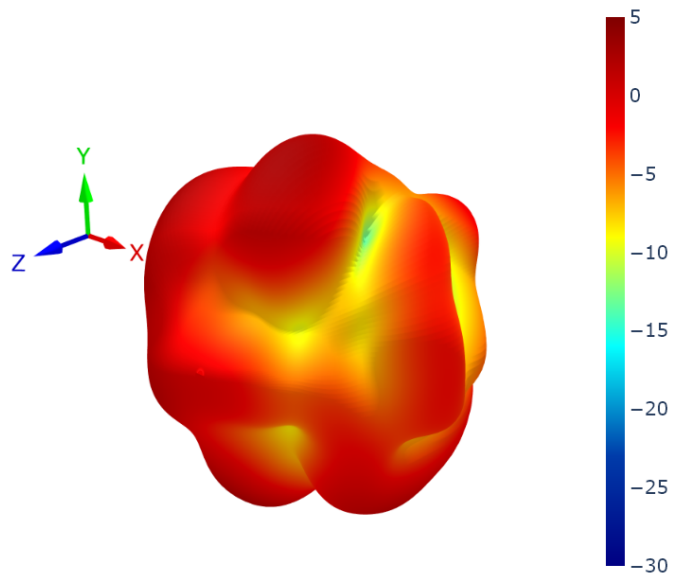

7.18 LTE2 Patterns at 1990 MHz

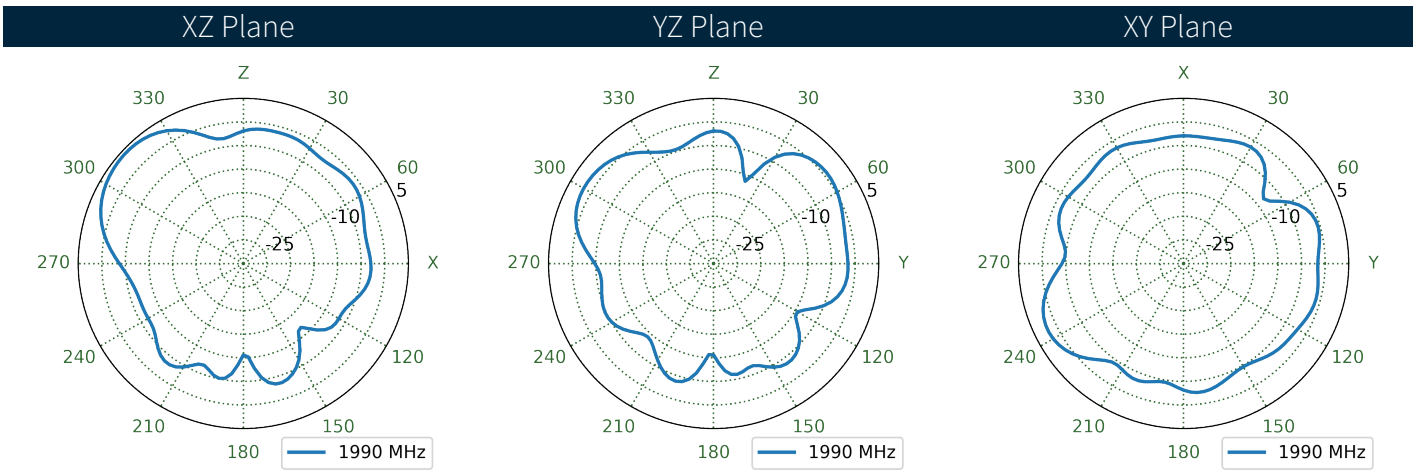
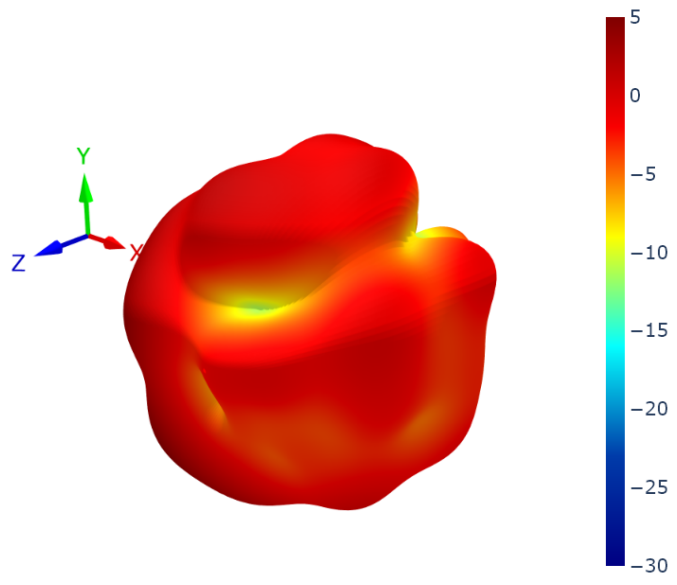

7.19 LTE1 Patterns at 2360 MHz

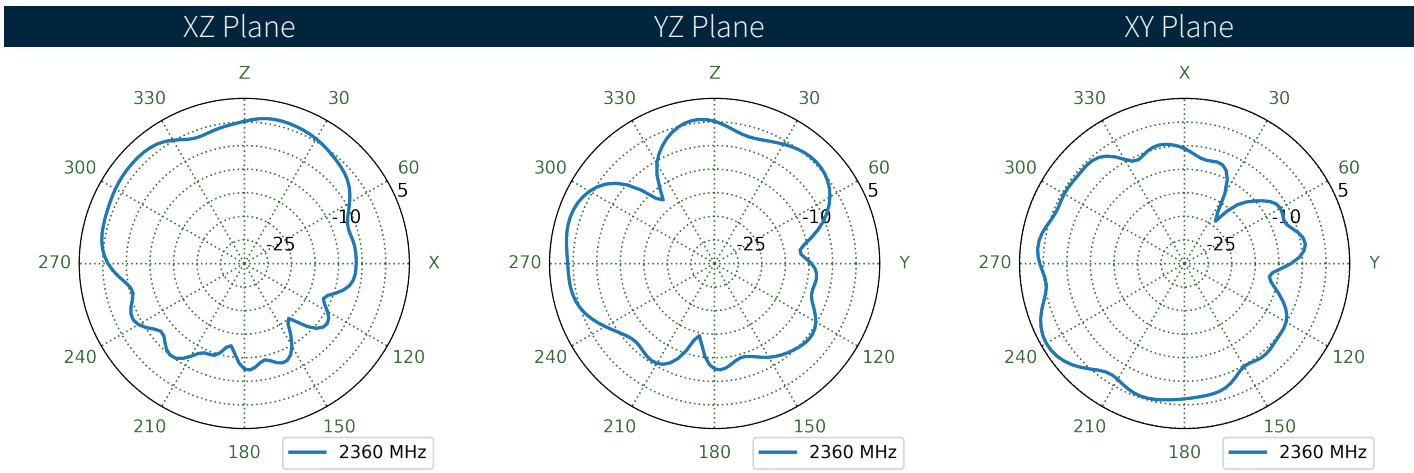
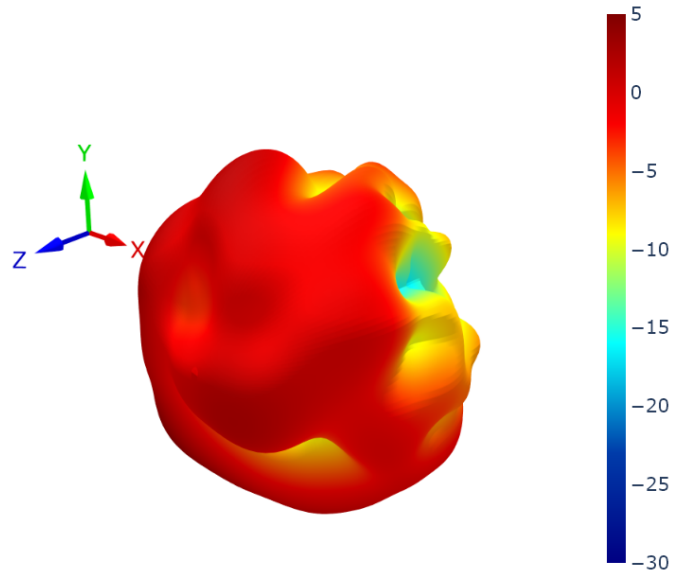

7.20 LTE2 Patterns at 2360 MHz

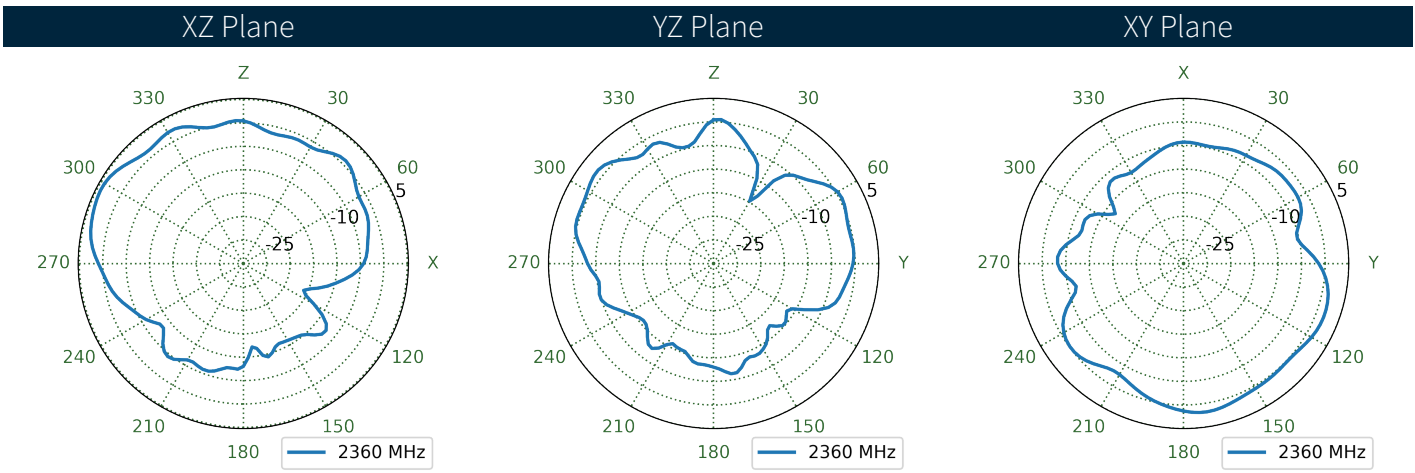
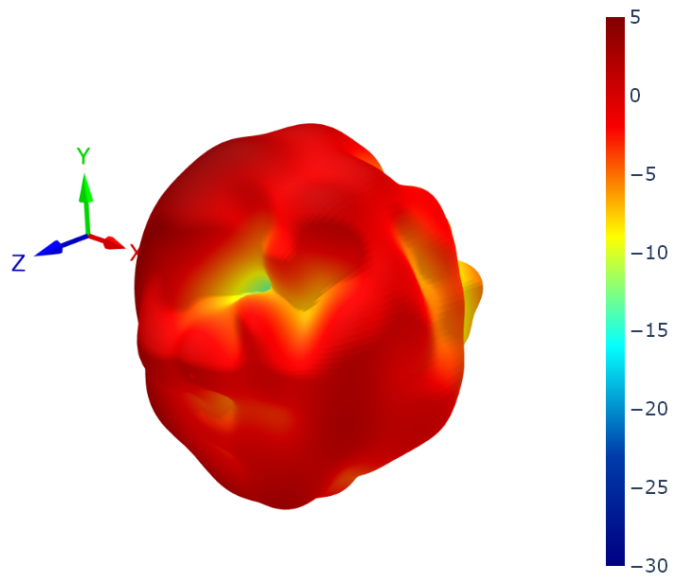

7.21 LTE1 Patterns at 2595 MHz

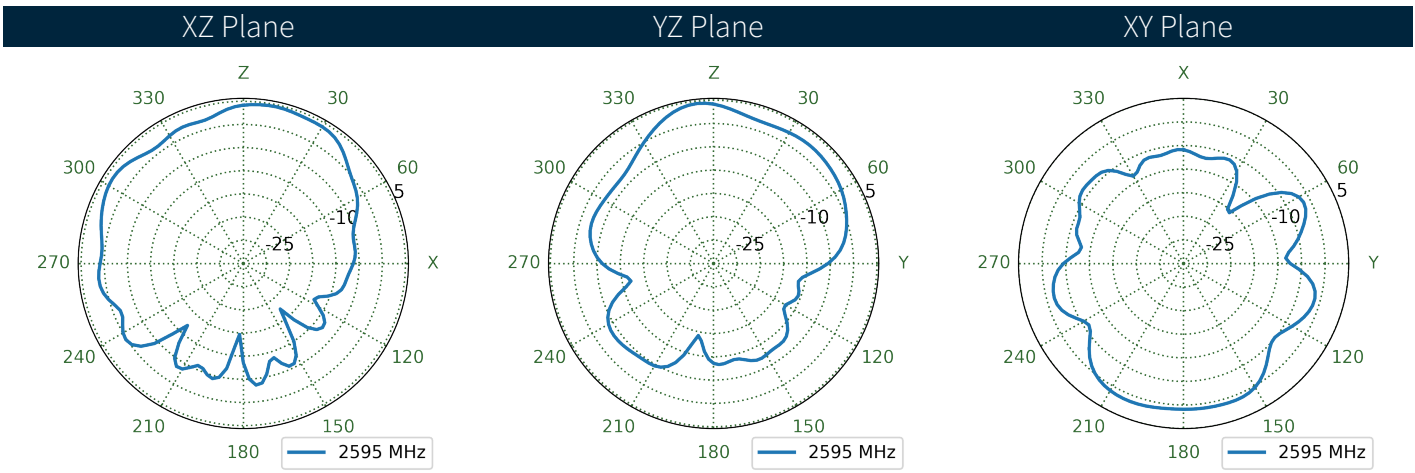
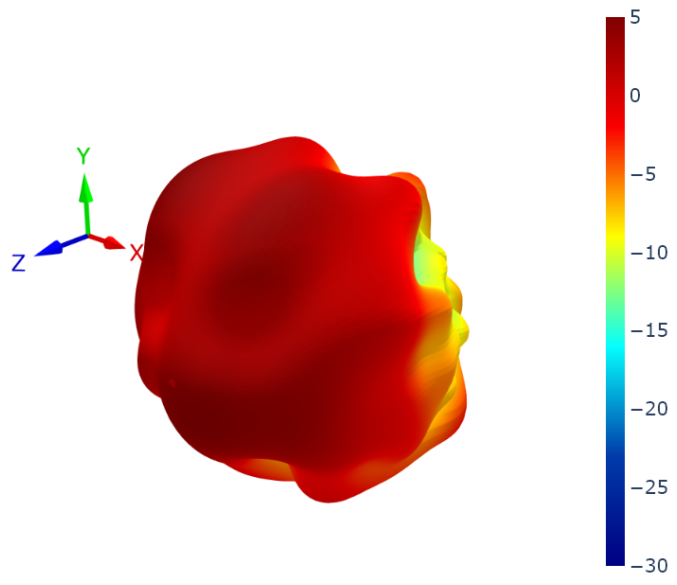

7.22 LTE2 Patterns at 2595 MHz

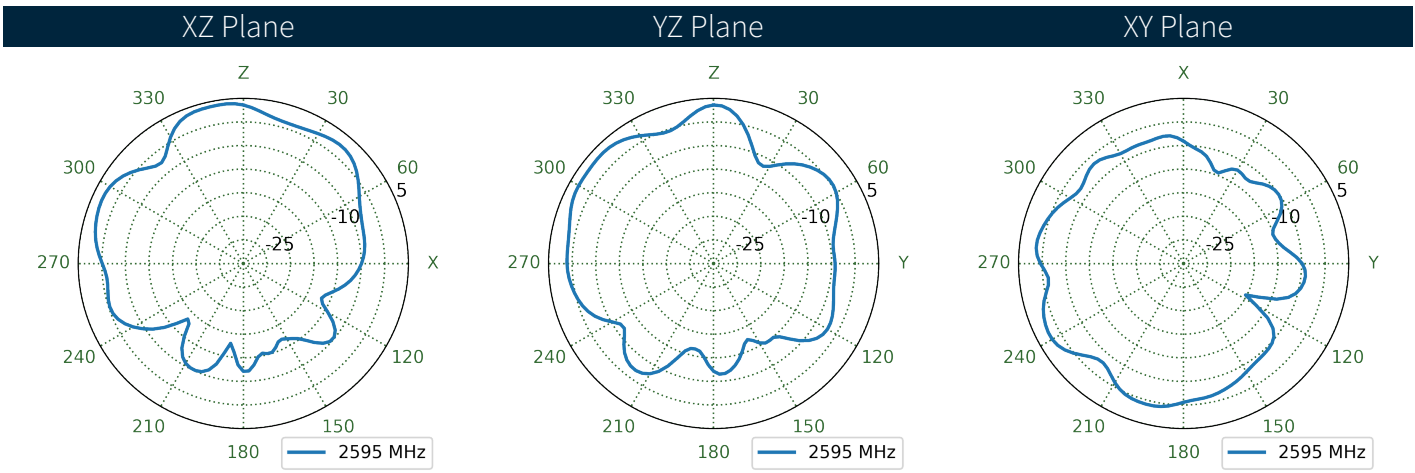
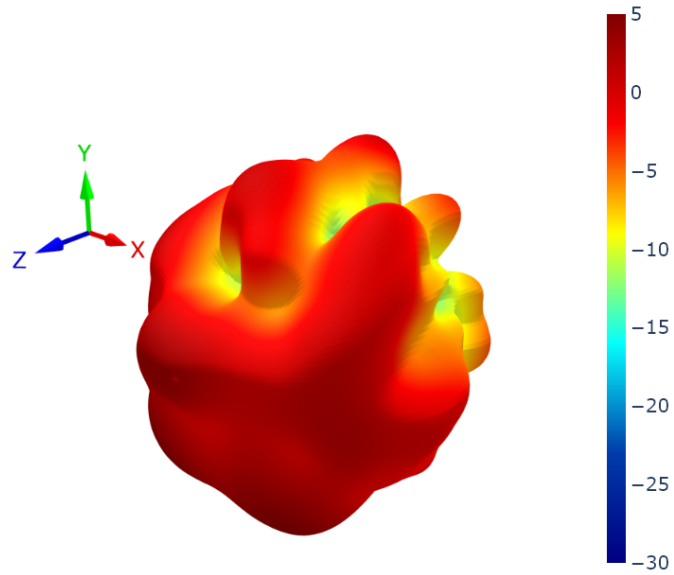

7.23 LTE1 Patterns at 3550 MHz

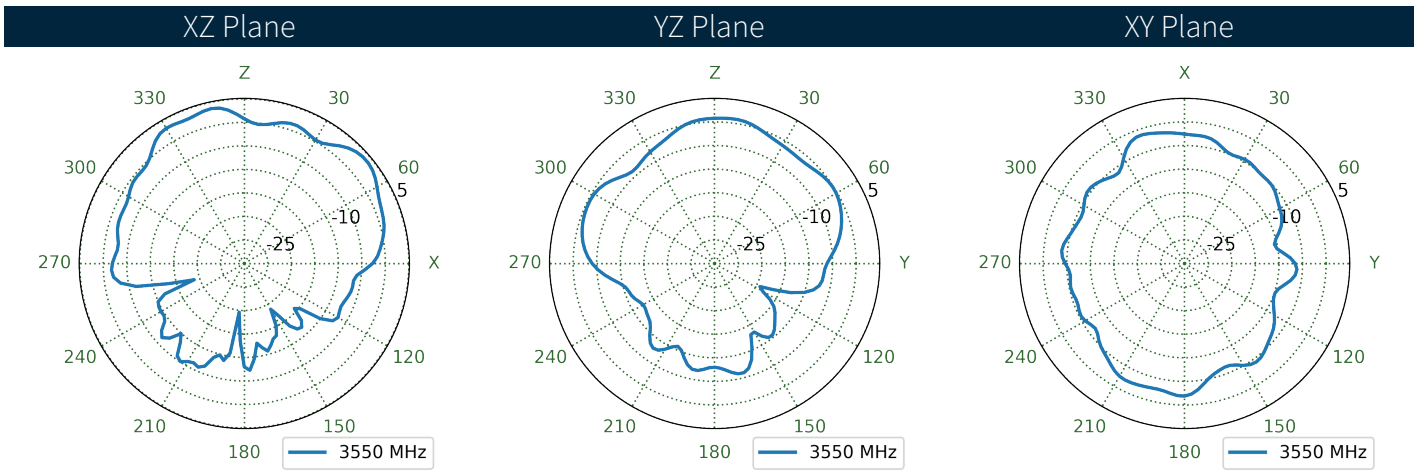
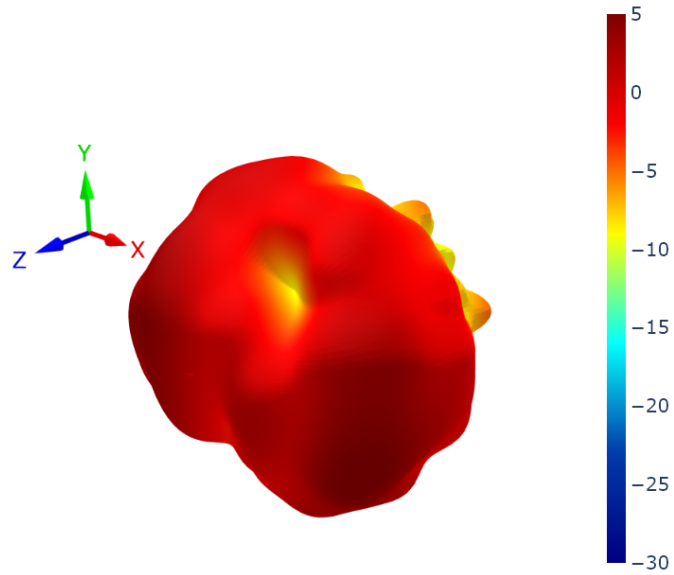



7.24 LTE2 Patterns at 3550 MHz

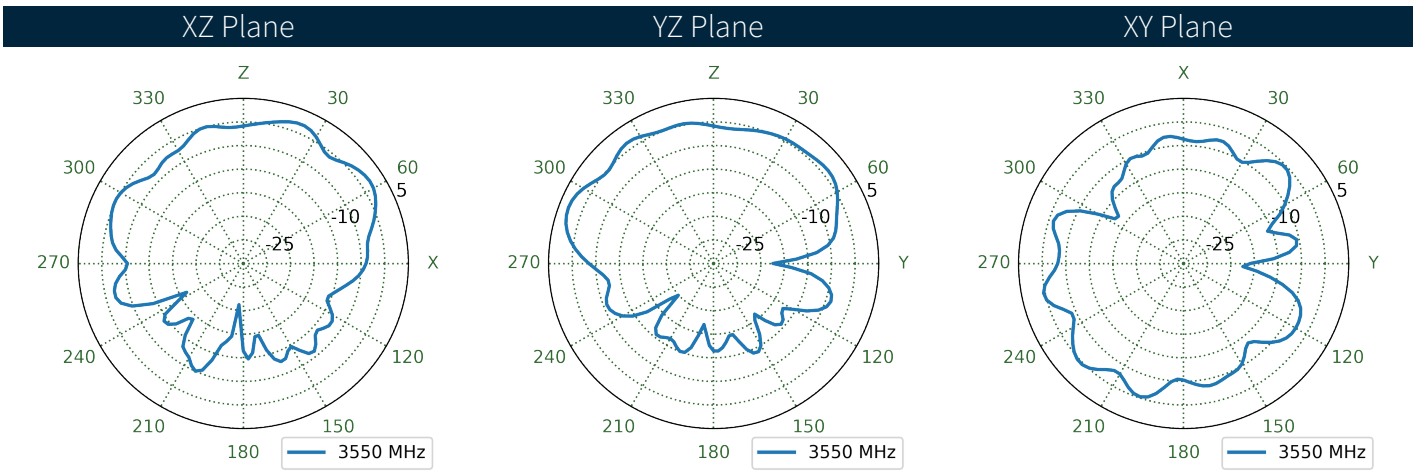
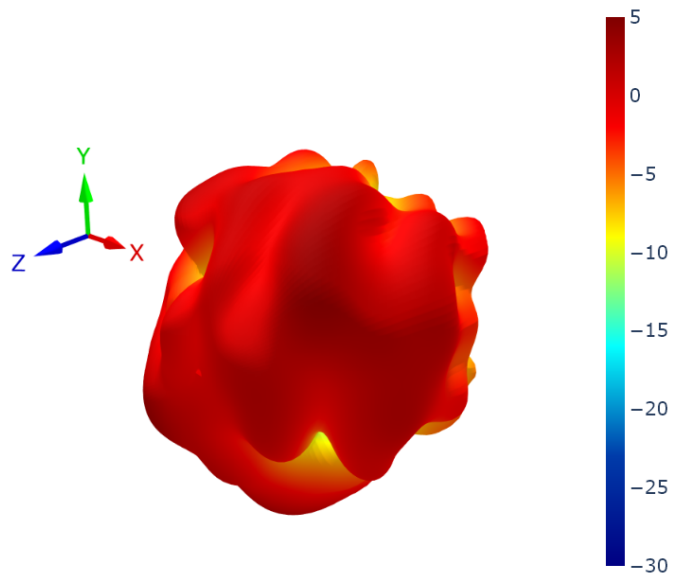

7.25 LTE1 Patterns at 4600 MHz

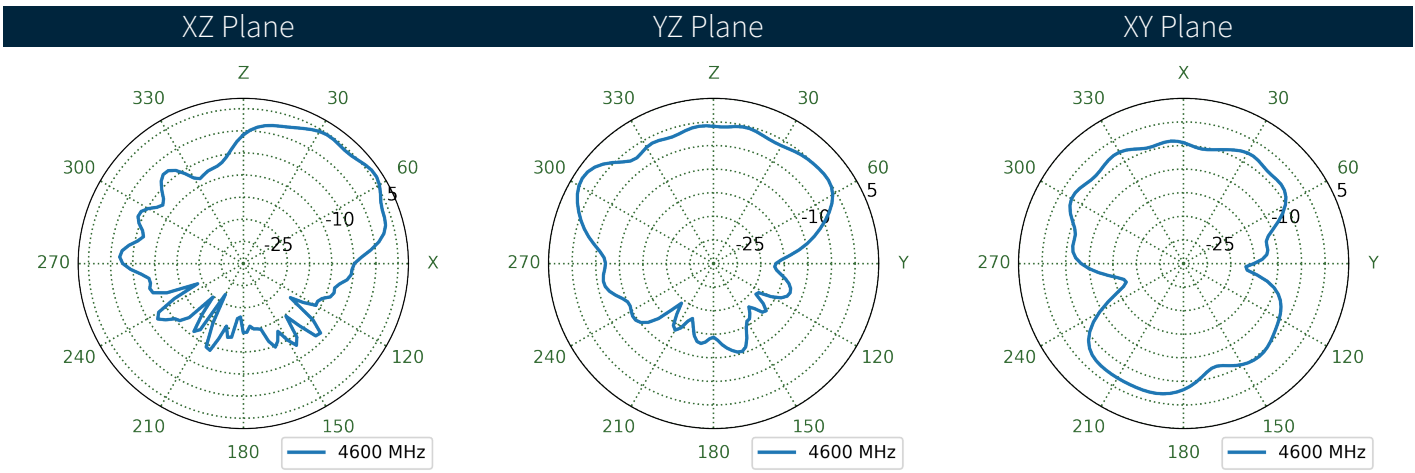
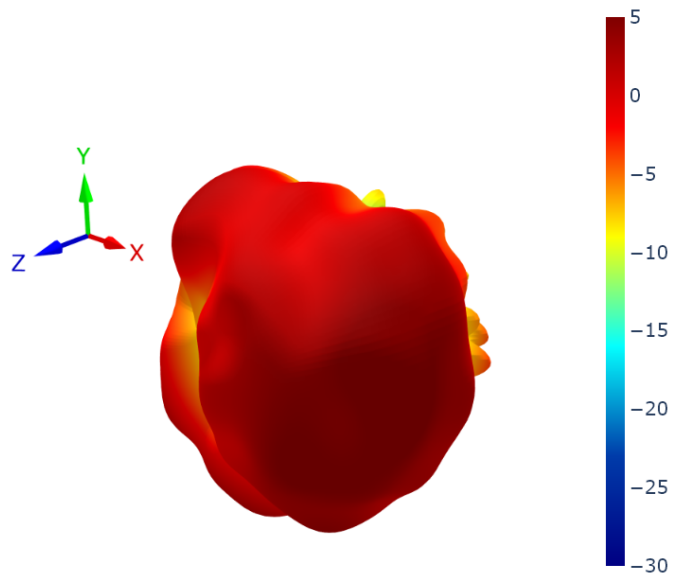

7.26 LTE2 Patterns at 4600 MHz

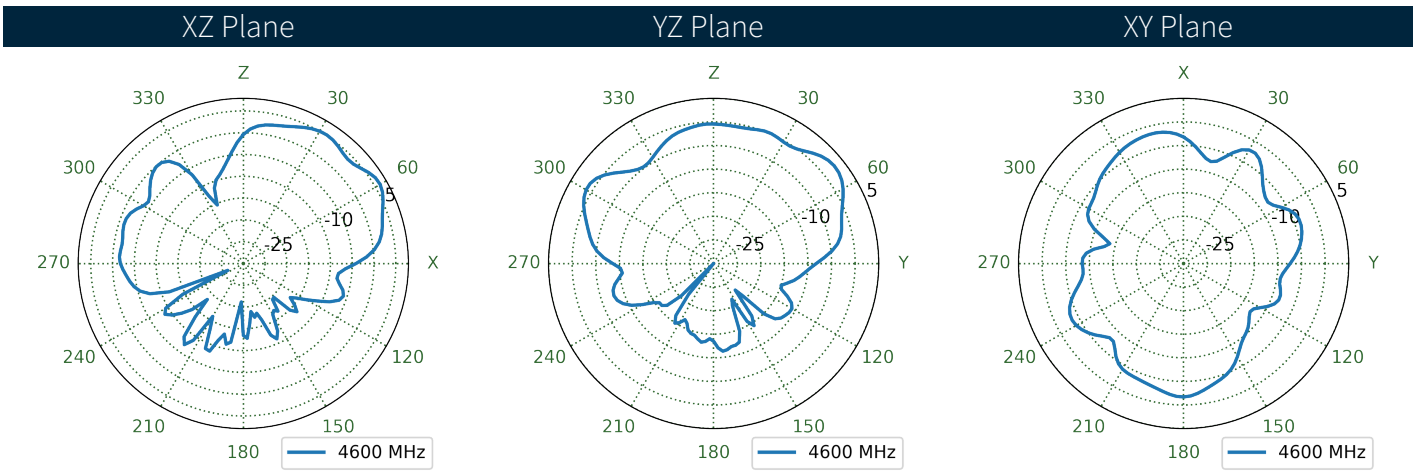
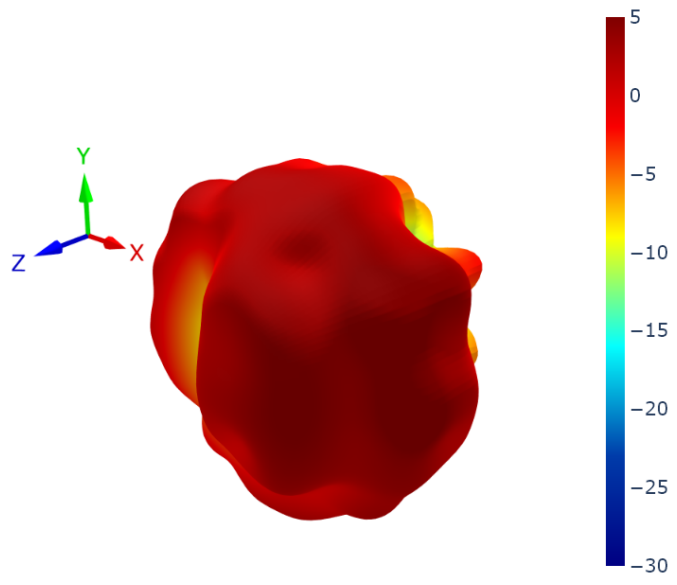

7.27 LTE1 Patterns at 4800 MHz

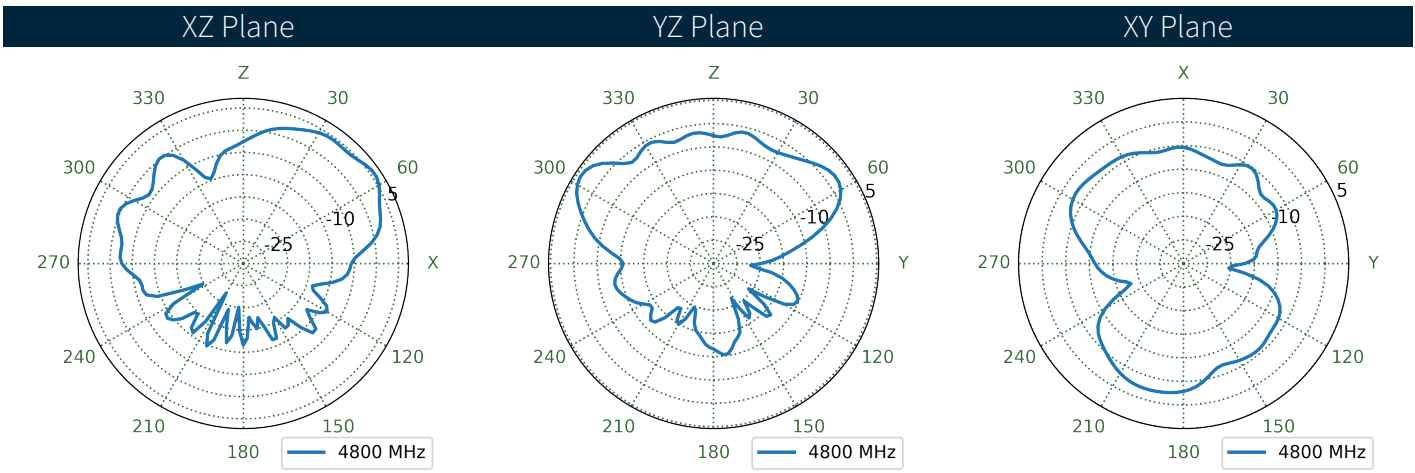
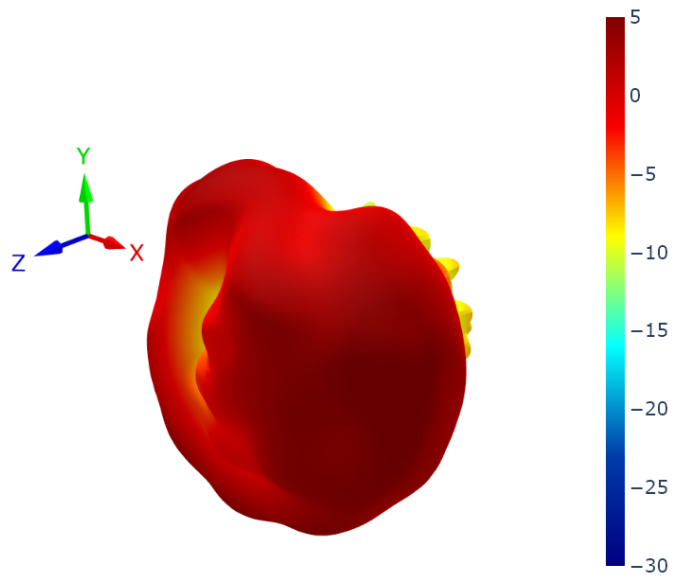

7.28 LTE2 Patterns at 4800 MHz

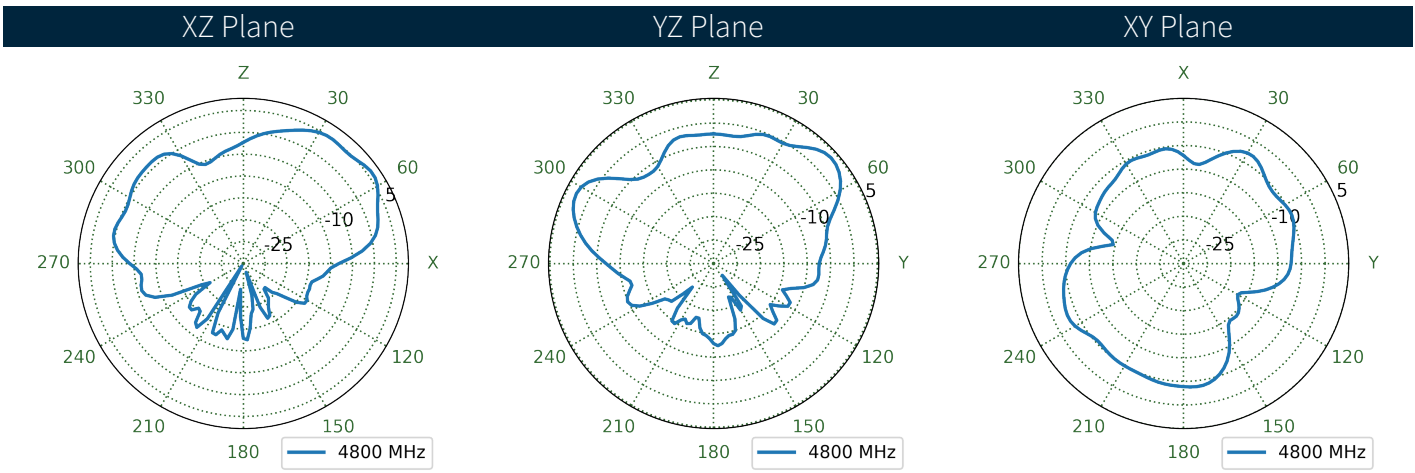
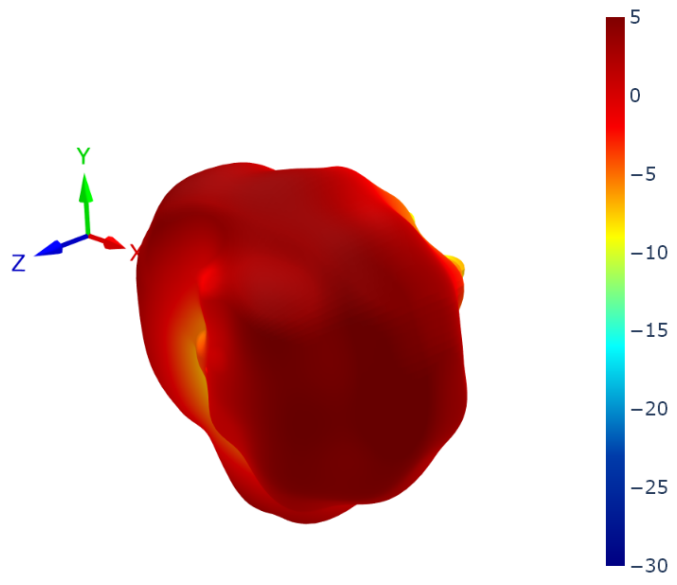

7.29 LTE1 Patterns at 5530 MHz

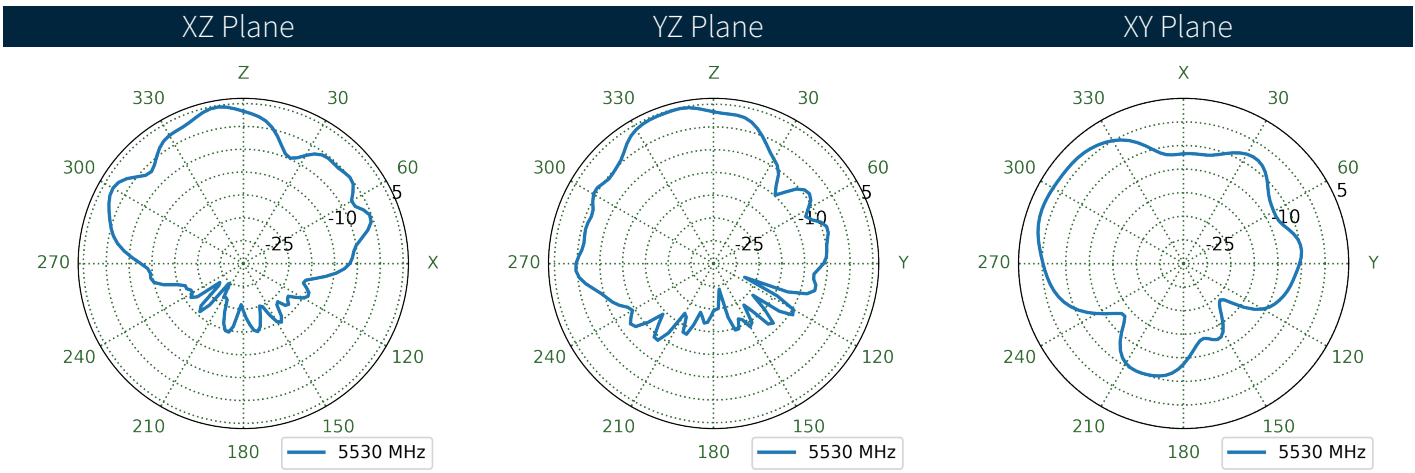
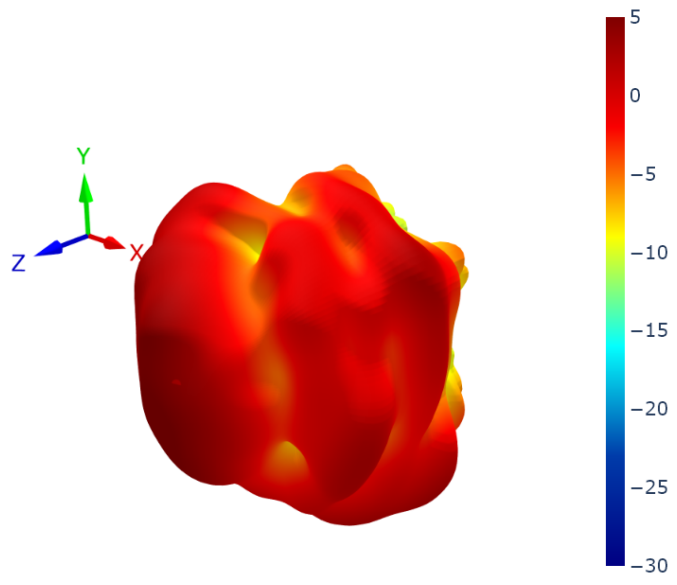

7.30 LTE2 Patterns at 5530 MHz

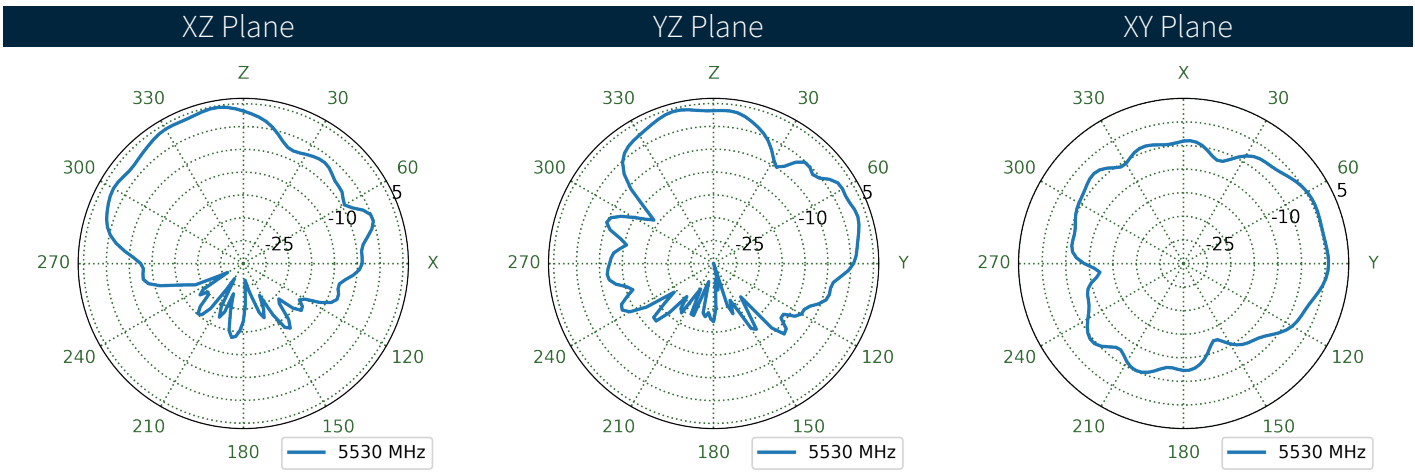
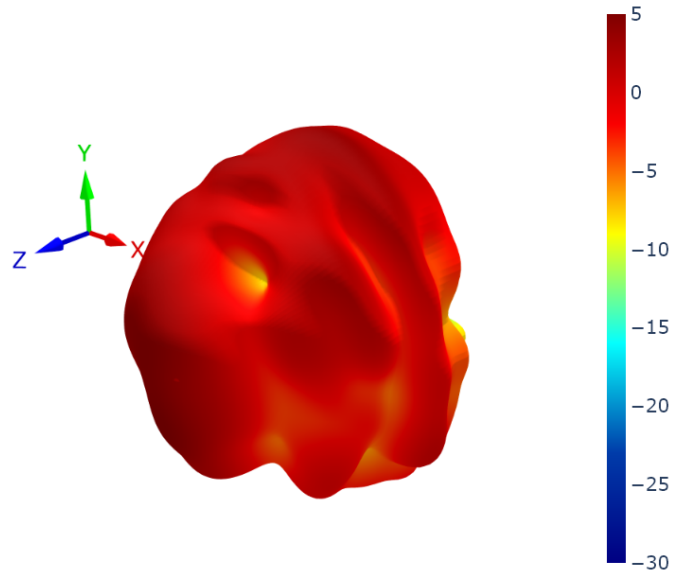

Changelog for the datasheet

**SPE-24-8-219 – MA343.W.LBI.001**

**Revision: A (Original First Release)**

Date: 2024-09-09

Notes: Initial Release

Author: Cesar Sousa

**Previous Revisions**





[www.taoglas.com](http://www.taoglas.com)

