

# THICK FILM PRECISION RESISTORS

## TYPE RT73 AEC-Q200 QUALIFIED SERIES

### INTRODUCTION

TE Connectivity (TE) brings you its metal-glaze high precision thick film resistor range, type RT73 series, available in four different packages with standard resistance values offered in E96 and E24 series. The resistance tolerance specifications are from 1% to 0.1% with low temperature co-efficient of resistance (T.C.R.) making the RT73 series suitable for use in automotive, measuring equipment and industrial measurement applications.

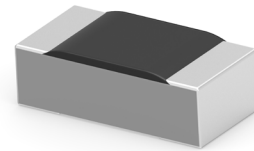

### FEATURES

- Metal glaze
- High precision
- Resistance tolerances -0.1%
- AEC-Q200 qualified
- MSL1 moisture sensitivity level

### APPLICATIONS

- Car electronics
- Industrial equipment
- Industrial measurement

### ELECTRICAL CHARACTERISTICS

		RT73 1E				RT73 1J				RT73 2A				RT73 2B			
Power rating		0.125 W				0.2 W				0.25 W				0.33 W			
Resistance range (Ω)	Min.	300	300	300	300	10	10	10	10	10	10	10	10	10	10	10	10
	Max.	100K	1M	1M	1M	1M	1M	1M	1M	3M	6.8M	10M	10M	1M	1M	10M	10M
Tolerance %		0.1	0.25	0.5	1.0	0.1	0.25	0.5	1.0	0.1	0.25	0.5	1.0	0.1	0.25	0.5	1.0
Code letter		B	C	D	E	B	C	D	E	B	C	D	E	B	C	D	E
TCR (PPM)		25/50															
Selection series		E96 E24															
Max. operating voltage		75 V				100 V				150 V				200 V			
Max. overload voltage		100 V				150 V				300 V				400 V			
Rated ambient temperature		85 °C															
Rated terminal part temperature		125 °C															
Operating temperature range		-55 °C ~ +150 °C															
Thermal resistance R <sub>th</sub> (K/W)		160				102				70				55			

# Thick Film Precision Resistors

Type RT73 AEC-Q200 Qualified Series

## ENVIRONMENTAL CHARACTERISTICS

Characteristics	Condition	Test Methods (JIS-C-5201-1)
Resistance	Within specified tolerance	25 °C
T.C.R	Within specified T.C.R	+25 °C/ -55 °C and +25 °C/ 125 °C
Overload (short term)	$\Delta R (\pm 0.2\% \text{ } 0.05 \Omega)$	*Rated voltage X 2.5 for 5s
Resistance to soldering	$\Delta R (\pm 0.2\% \text{ } 0.05 \Omega)$	260 °C $\pm 5$ °C, 10 s $\pm 1$ s
Moisture resistance	$\Delta R (\pm 0.2\% \text{ } 0.05 \Omega)$ : 1E(300 $\Omega \leq R \leq 20 \text{ k}\Omega$ ) 1J (10 $\Omega \leq R \leq 200 \text{ k}\Omega$ ) 2A, 2B (10 $\Omega \leq R \leq 1 \text{ M}\Omega$ )	40 °C $\pm 2$ °C, 90% - 95% RH, 1000 h 1.5 h ON/ 0.5 h OFF cycle
Endurance at 85°C or rated terminal part temperature	$\Delta R (\pm 0.2\% \text{ } 0.05 \Omega)$ : 1E(300 $\Omega \leq R \leq 20 \text{ k}\Omega$ ) 1J (10 $\Omega \leq R \leq 200 \text{ k}\Omega$ ) 2A, 2B(10 $\Omega \leq R \leq 1 \text{ M}\Omega$ )	85 °C $\pm 2$ °C or rated terminal part temperature $\pm 2$ °C 1000 h 1.5 ON/ 0.5 OFF cycle
High temperature exposure	$\Delta R (\pm 0.2\% \text{ } 0.05 \Omega)$ : 1E(300 $\Omega \leq R \leq 10 \text{ k}\Omega$ ) 1J (10 $\Omega \leq R \leq 200 \text{ k}\Omega$ ) 2A, 2B (10 $\Omega \leq R \leq 100 \text{ k}\Omega$ )	+155 °C, 1000 h
Withstanding voltage	$\Delta R (\pm 0.2\% \text{ } 0.05 \Omega)$	60 +10/ -0 (applied voltage) RT73 1E, 1J DC100V RT73 2A, 2B DC500V

\*Overload voltage is rated X 2.5 or maximum overload voltage, whichever is lower.

## AEC-Q200 TEST DATA

Characteristics	Condition	Test Methods (JIS-C-5201-1)
High temperature exposure	$\Delta R \pm 0.5\%$	<b>MIL-STD-202 Method</b> 108 $\pm 155$ °C, 1000 h
Temperature cycling	$\Delta R \pm 0.2\%$	<b>JESD22 Method JA-104</b> -55 °C/ 125 °C each 30 min. 1000 cycles
Biased humidity	$\Delta R \pm 0.2\%$	<b>MIL-STD-202 method 103</b> 85 °C RH rated wattage/ 10 1.5 hr-ON/ 0.5 hr- OFF 1000 hrs
Operational life	$\Delta R \pm 0.5\%$	<b>MIL-STD-202 method 108</b> 125 °C derating wattage 1.5 hr-ON/ 0.5 hr-OFF 2000 hrs
External visual	-	<b>MIL-STD-883 method 2009</b> Visual check
Physical dimension	-	<b>JESD22 method JB-100</b> Delivery specification
Resistance to solvents	$\Delta R \pm 1.0\%$	<b>MIL-STD-202 method 215</b> Solvent a/c: 25 °C 3min. solvent d: 63 °C- 70 °C 3min.
Mechanical shock	$\Delta R \pm 1.0\%$	<b>MIL-STD-202 method 213 Test Condition C</b> 100G 6 ms.(half sine wave) X, Y, Z each direction $\pm 3$ shocks total 18 shocks
Vibration	$\Delta R \pm 1.0\%$	<b>MIL-STD-202 method 204</b> 10 Hz-2000 Hz-10 Hz/ 20 min. 1.5 mm double amplitude (5G max.) X, Y, Z each direction 4 hrs. total 12 hrs.
Resistance to soldering heat	$\Delta R \pm 0.2\%$	<b>MIL-STD-202 method 210 Test Condition B</b> 260 °C 10 sec. dipping
ESD (HBM)	$\Delta R \pm 1.0\%$ RT73 1E, 1J Class 1B RT73 2A, 2B Class 2	<b>AEC-Q200-002</b> 150 pF 2k $\Omega \pm 1$ discharge
Solderability	95% min. coverage	<b>J-STD-002</b> a) Method B 4 hrs. @ 155 °C, dry heat @ 235 °C b) Method B @ 215 °C, category 3 c) Method D @ 260 °C, category 3

# Thick Film Precision Resistors

Type RT73 AEC-Q200 Qualified Series

Characteristics	Condition	Test Methods (JIS-C-5201-1)
Electrical characterisation	-	Delivery Specification Temperature coefficient of resistance -55 °C/ 125 °C (25 °C basis)
Board flex	$\Delta R \pm 0.2\%$	<b>AEC-Q200-005</b> Bend 2 mm 60 sec.
Terminal strength	$\Delta R \pm 1.0\%$	<b>AEC-Q200-006</b> Shear stress 17.7 N 60 sec.
Flame retardance	-	<b>AEC-Q200-001</b> 9.0 VDC ~ 32.0 VDC each 1 hr.
Tin whisker	<45 $\mu\text{m}$ (temperature cycling) <40 $\mu\text{m}$ (ambient temperature/ humidity storage)	<b>AEC-Q005</b> <ul style="list-style-type: none"> <li>• Condition 1: Temperature cycling -55 °C/ 85°C 3 cys/hr</li> <li>• Condition 2: Ambient temperature/ humidity storage (30°C 60%RH)</li> <li>• Condition 3: Ambient temperature/ humidity storage (60°C 87%RH)</li> </ul>

## DERATING CURVE

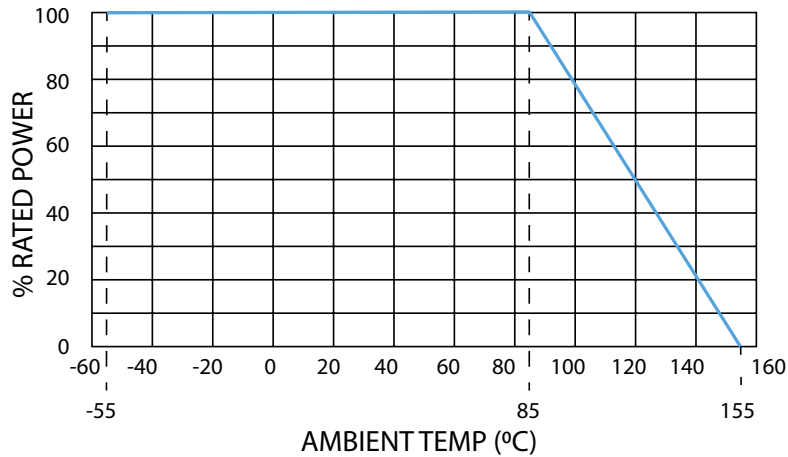

**Note:** For resistors operated at an ambient temperature of 85°C or higher, the power shall be derated in accordance with the above derating curve.

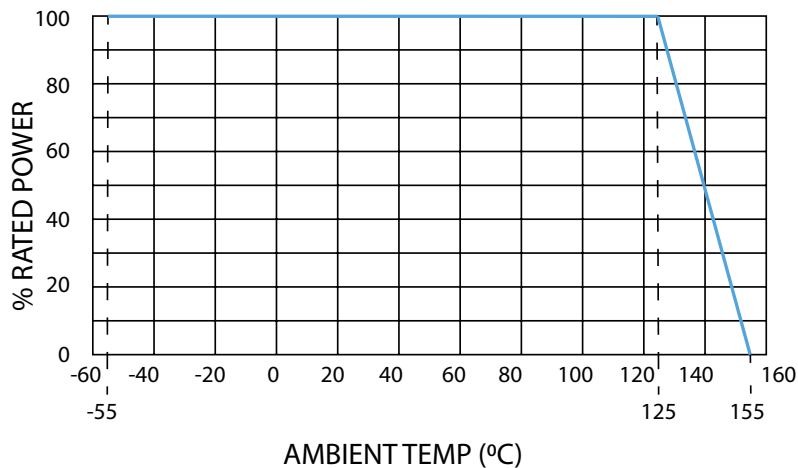

**Note:** When the terminal part temperature of the resistor exceeds the rated terminal part temperature shown above, the power shall be derated according to the derating curve.

# Thick Film Precision Resistors

Type RT73 AEC-Q200 Qualified Series

## TEMPERATURE RISE

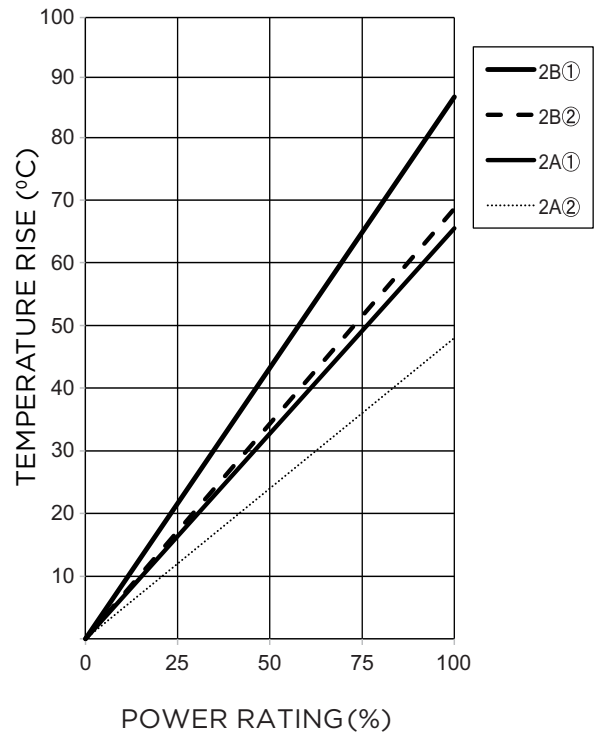
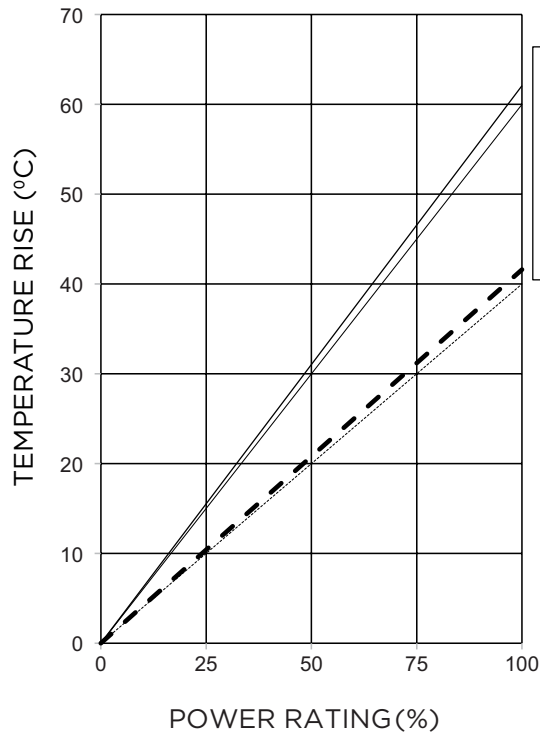

**Measurement condition:**

Room temperature: 25 °C  
 PCB: FR-4t = 1.6mm  
 Cu foil thickness: 35µm

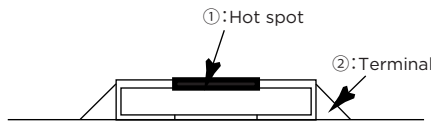

**Note:** For guidance only. Testing was carried out in controlled laboratory conditions. We recommend testing in the intended application.

## CONSTRUCTION AND DIMENSIONS

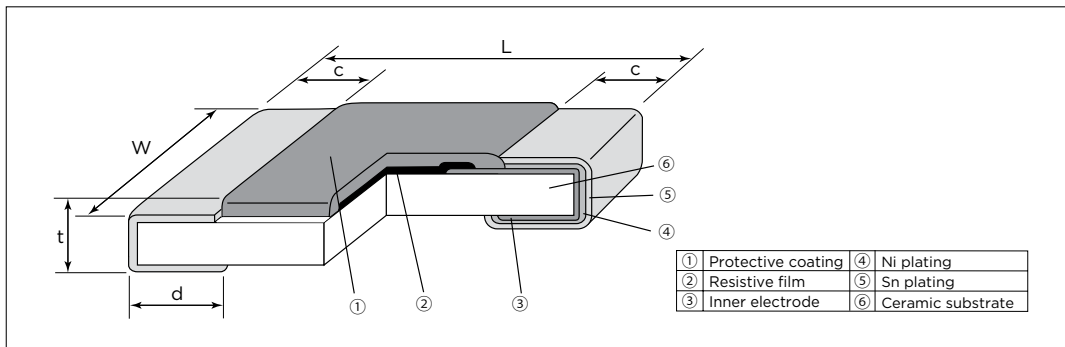

Type	L (mm)	W (mm)	c (mm)	d (mm)	t (mm)	Weight (mg)
RT73 1E	1.0 +0.1/ -0.05	0.5 ±0.05	0.2 ±0.1	0.25 +0.05/ -0.1	0.35 ±0.05	0.68
RT73 1J	1.6 ±0.2	0.8 ±0.1	0.2 ±0.1	0.3 ±0.1	0.45 ±0.1	2.14
RT73 2A	2.0 ±0.2	1.25 ±0.1	0.25 ±0.15	0.3 +0.2/ -0.1	0.5 ±0.1	4.54
RT73 2B	3.2 ±0.2	1.6 ±0.2	0.35 ±0.15	0.4 +0.2/ -0.1	0.6 ±0.1	9.14

# Thick Film Precision Resistors

Type RT73 AEC-Q200 Qualified Series

## SINGLE PULSE

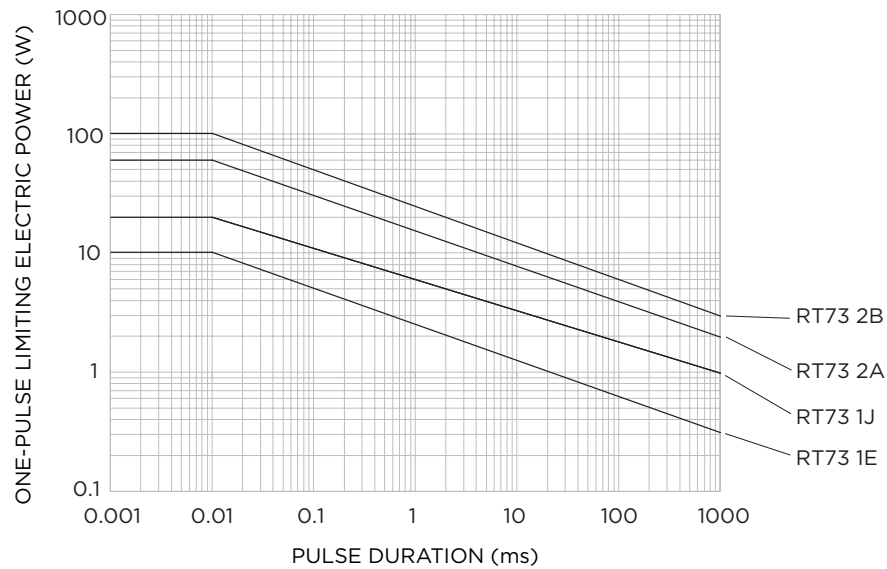

**Note:** For guidance only. The maximum applicable voltage is equal to the max. overload voltage. The pulse endurance values are not assured values, and it is recommended testing in the intended application.

## RECOMMENDED LAND PATTERN

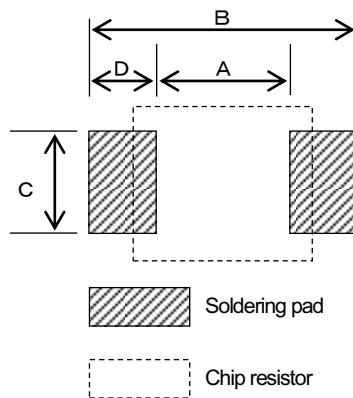

Type	A (mm)	B (mm)	C (mm)	D (mm)
RT73 1E	0.5	1.3	0.3	0.4
RT73 1J	1.0	2.0	0.6	0.5
RT73 2A	1.3	2.5	1.05	0.6
RT73 2B	2.2	4.0	1.4	0.9

## COATING COLOUR AND MARKING

Type	Coating Colour	Marking
RT73 1E	Black	No Marking
RT73 1J		
RT73 2A		
RT73 2B		

**SOLDERING REFLOW PROFILE**

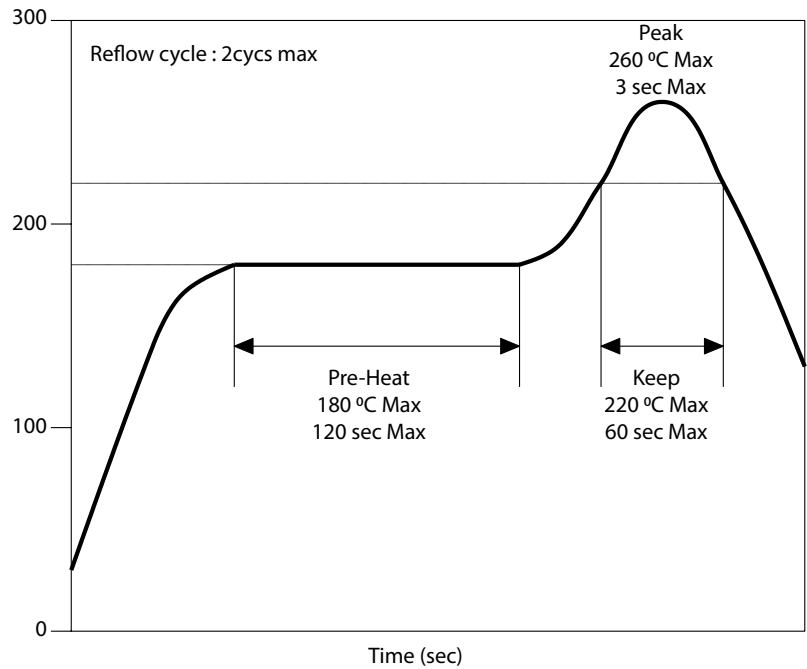

**PACKAGING**

**Paper Tape**

Leader and end tape

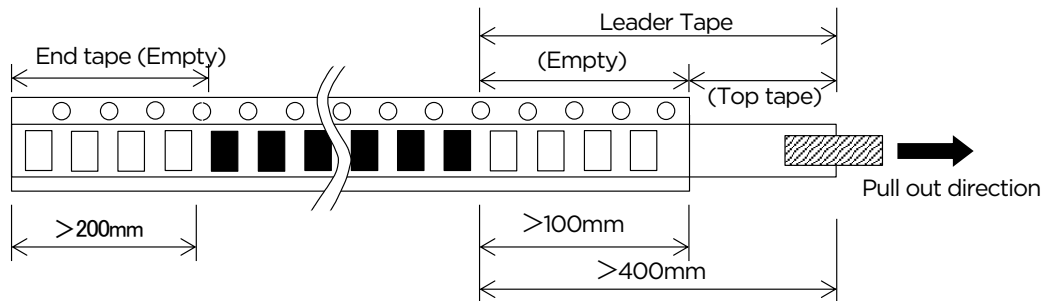

**Paper Tape Dimensions (mm)**

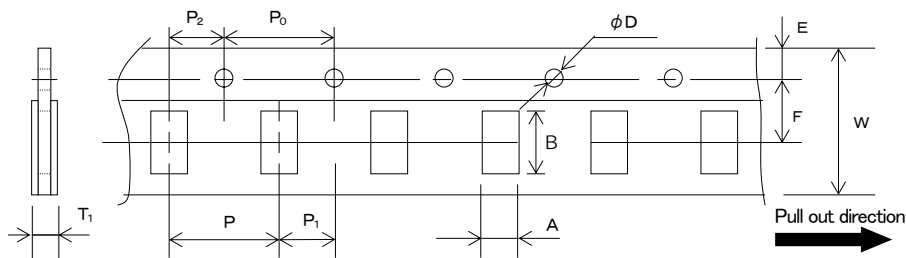

Type	A (mm)	B (mm)	D (mm)	E (mm)	F (mm)	P (mm)	$P_0$ (mm)	$P_1$ (mm)	$P_2$ (mm)	$T_1$ (mm)	W (mm)
RT73 1E	0.65 ±0.10	1.15 ±0.10	1.5 +0.1/ -0	1.75 ±0.1	3.5 ±0.05	-	4.0 ±0.1	2.0 ±0.05	2.0 ±0.05	0.42 +0.2/ -0	8.0 ±0.2
RT73 1J	1.10 ±0.10	1.90 ±0.10				4.0 ±0.1	4.0 ±0.1	-		0.6 +0.2/ -0	
RT73 2A	1.65 ±0.20	2.40 ±0.20				4.0 ±0.1	4.0 ±0.1	-		0.75 +0.2/ -0	
RT73 2B	2.00 ±0.20	3.50 ±0.20				4.0 ±0.1	4.0 ±0.1	-			

## REEL DIMENSIONS

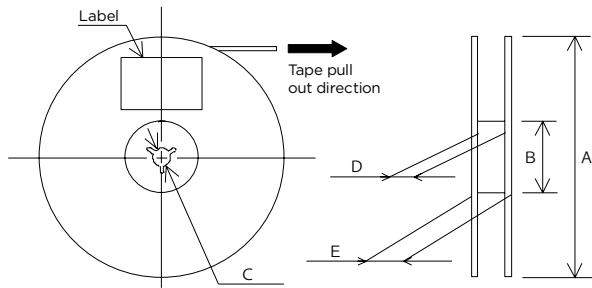

Type	A (mm)	B (mm)	C (mm)	D (mm)	E (mm)	Qty
RT73 1E	180 +0/ -3	60 +1/ -0	13 ±0.2	8.4 +1.5/ -0	12.4 ±0.2	10,000
RT73 1J						5,000
RT73 2A						5,000
RT73 2B						5,000

## ORDERING INFORMATION

Part Number	
RT73 F 1E 10R B TH	
<b>Common Part</b>	
RT73	Standard
<b>TCR</b>	
F	*25 PPM
G	50 PPM
<b>Package Size</b>	
1E	0402
1J	0603
2A	0805
2B	1206
<b>Packaging</b>	
TH	10,000 pcs
TD	5,000 pcs
<b>Tolerance</b>	
B	*0.1%
C	0.25%
D	0.5%
F	1%
*Preferred TCR and tolerance, other options offered on demand	
<b>Resistance Value</b>	
10R	10 ohm (10Ω)
100R	100 ohm (100Ω)
1K0	1K ohm (1000Ω)
10K	10K ohm (10000Ω)
100K	100K ohm (100000Ω)
1M	1M ohm (1000000Ω)

## te.com

©2024 TE Connectivity Ltd. Family of Companies. All Rights Reserved.

TE Connectivity, TE connectivity (logo) and Every Connection Counts are trademarks owned or licensed by the TE Connectivity plc. family of companies. All other logos, products and/or company names referred to herein might be trademarks of their respective owners.

While TE has made every reasonable effort to ensure the accuracy of the information in this document, TE does not guarantee that it is error-free, nor does TE make any other representation, warranty or guarantee that the information is accurate, correct, reliable or current. TE reserves the right to make any changes to the information contained herein without prior notice. TE Connectivity assumes only those obligations set forth in the terms and conditions for this product and shall in no event be liable for any incidental, indirect, or consequential damages arising out of the sale, resale, use, or misapplication of the product. TE expressly disclaims any implied warranties with respect to the information contained herein, including, but not limited to, implied warranties of merchantability or fitness for a particular purpose. Dimensions, specifications and/or information contained herein are for reference purposes only and are subject to change without notice. Consult TE for the latest dimensions, specifications and/or information. Users of TE Connectivity products must make their own assessment as to whether the respective product is suitable for the respective desired application.

09/24 1773450 REV:A ED