

# Part No. 1004795 / 1004796

## Embedded 5G / LTE / NTN / GNSS SMT Antenna

315 MHz / 400 MHz / 433 MHz / 450 MHz / 600 – 960 MHz / 1710 – 2690 MHz / 1525 – 1660 MHz / 1559 – 1610 MHz / 1980 – 2200 MHz

Supports: 5G, LTE, LTE CAT-M, NB-IoT, LoRa, Cellular, LPWA, ISM, GNSS, NTN (S-Band/L-Band)



\*Mirrored version offered as 1004796

### Embedded 5G / LTE / NTN / GNSS SMT Antenna

Low Band: 698 – 1000 MHz  
 Mid Band: 1700 – 2400 MHz  
 High Band: 2500 – 2700 MHz  
 Appendix 1: 315, 400, 433, 450 MHz  
 Appendix 2: 600 – 960 / 1710 – 2400 MHz  
 / 1525 – 1600 MHz / 1559 – 1610 MHz /  
 1980 – 2200 MHz / 2500 – 2700 MHz

#### KEY BENEFITS

##### Reduced Costs and Time-to-Market

Standard antenna eliminates design fees and cycle time associated with a custom solution; getting products to market faster.

##### Greater Flexibility with Unique Form Factors

KYOCERA AVX's technology helps you deliver more advanced ergonomic designs without adverse impact on product performance.

##### Environmental Compliance

Comply with latest RoHS requirements

#### APPLICATIONS

- Healthcare applications (FDA Class I)
- Smart metering
- M2M, Industrial devices
- IoT devices
- Point of Sale
- Tracking / Telematics
- Satellite Communications
- Satellite IoT
- Smart City

KYOCERA AVX's Embedded 5G / LTE / NTN / GNSS SMT Antenna utilize IMD technology, which offers a reduced electrical footprint on any circuit board and independent tuning capabilities for performance optimization.

### High Performance 5G / LTE / NTN / GNSS in Small form factor

This 5G/LTE antenna is designed to support all worldwide major carriers. In addition, the versatility to retune to other frequency bands, allows this antenna to perform at 315MHz for RKE applications, 450MHz for the LTE band B31, 433MHz ISM bands as well as 400MHz satellite applications. It's also supporting GNSS as well as NTN with coverage of S-Band and L-Band for IoT Satellite. This antenna is the perfect solution for IoT enabled devices, offering high efficiency and peak gain in a small form factor, and with a reduced ground plane size requirement.

### Electrical Specifications

Typical 1004795 performance 125 x 45 mm PCB

Frequency (MHz)	315, 400, 433, 450	600-698	698-960	1525 – 1600 1559 – 1610 1980 - 2200	1710-2400	2500-2700
Peak Gain	Refer to Appendix 1	Refer to Appendix 2	1.6 dBi	Refer to Appendix 3	3.1 dBi	1.7 dBi
Average Efficiency			64%		55%	53%
VSWR			< 2.5:1			< 3.0:1
Polarization	Linear					
Power Handling	2 Watt CW					
Feed Point Impedance	50 Ω unbalanced					
Additional Resources	<a href="#">Download Application Note and Simulation Files</a>					

1004795 / 1004796 Embedded 5G / LTE / NTN / GNSS KYOCERA AVX SMT Antenna Specifications.  
 KYOCERA AVX produces a wide variety of standard and custom antennas to meet user needs.

**Mechanical Specifications & Ordering Part Number**

Ordering Part #	1004795	1004796
Dimensions (mm)	36.0 x 9.0 x 3.2	36.0 x 9.0 x 3.2
Mounting Type	SMT (P&P)	
Variant	1004796: Mirrored version of 1004795	
Weight (grams)	2.1	
Packaging	Tape and Reel	
Storage Temperature / Humidity <small>(Sealed shipping package)</small>	+5°C to +35°C / 45~75%	
Operating Temperature	-40 to +85 C	
Demo Board	1004795-01 (1004795) 1004796-01 (1004796)	
Additional Resources	<a href="#">Download DXF, Gerber and 3D Fit Files</a>	

1004795 / 1004796 Embedded 5G / LTE / NTN / GNSS KYOCERA AVX SMT Antenna Specifications.  
 KYOCERA AVX produces a wide variety of standard and custom antennas to meet user needs.

**LTE Bands covered by (1004795/1004796)**

LTE Band	Frequency Band (MHz)	Uplink (UL) (MHz)	Downlink (DL) (MHz)	Region	Covered
1	2100	1920 - 1980	2110 - 2170	Global	Yes
2	1900	1850 - 1910	1930 - 1990	NAM	
3	1800	1710 - 1785	1805 - 1880	Global	
4	1700	1710 - 1755	2110 - 2155	NAM	
5	850	824 - 849	869 - 894	NAM	
6	850	830 - 840	875 - 885	APAC	
7	2600	2500 - 2570	2620 - 2690	EMEA	
8	900	880 - 915	925 - 960	Global	
9	1800	1749.9 - 1784.9	1844.9 - 1879.9	APAC	
10	1700	1710 - 1770	2110 - 2170	NAM	
11	1500	1427.9 - 1447.9	1475.9 - 1495.9	Japan	No
12	700	699 - 716	729 - 746	NAM	Yes
13	700	777 - 787	746 - 756	NAM	
14	700	788 - 798	758 - 768	NAM	
17	700	704 - 716	734 - 746	NAM	
18	850	815 - 830	860 - 875	Japan	
19	850	830 - 845	875 - 890	Japan	
20	800	832 - 862	791 - 821	EMEA	
21	1500	1447.9 - 1462.9	1495.9 - 1510.9	Japan	No
22	3500	3410 - 3490	3510 - 3590	EMEA	Yes
23	2000	2000 - 2020	2180 - 2200	NAM	Yes
24	1600	1626.5 - 1660.5	1525 - 1559	NAM	Yes
25	1900	1850 - 1915	1930 - 1995	NAM	
26	850	814 - 849	859 - 894	NAM	
27	850	807 - 824	852 - 869	NAM	
28	700	703 - 748	758 - 803	APAC,EU	
29	700	N/A	717 - 728	NAM	
30	2300	2305 - 23151	2350 - 2360	NAM	
31	450	452.5 - 457.5	462.5 - 467.5	Global	No
32	1500	N/A	1452 - 1496	EMEA	
33	1900		1900 - 1920		Yes
34	2000		2010 - 2025		
35	1850		1850 - 1910		
36	1900		1930 - 1990		
37	1900		1910 - 1930		
38	2600		2570 - 2620		
39	1900		1880 - 1920		
40	2300		2300 - 2400		
41	2500		2496 - 2690		
42	3500		3400 - 3600		
43	3700		3600 - 3800		

1004795 / 1004796 Embedded 5G / LTE / NTN / GNSS KYOCERA AVX SMT Antenna Specifications.  
 KYOCERA AVX produces a wide variety of standard and custom antennas to meet user needs.

**Antenna Dimensions (1004795)**

Typical antenna dimensions (mm)

Part Number	A	B	C
1004795	36.0 ± 0.2	9.0 ± 0.2	3.2 ± 0.33

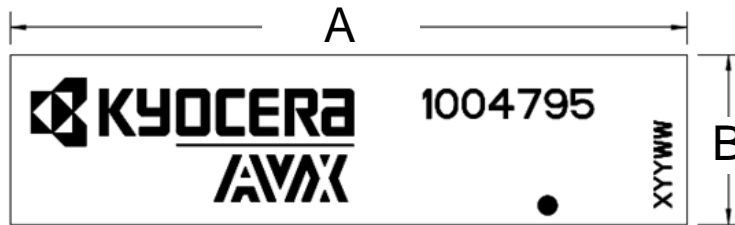

**Top View**



**Front View/Height**

Pin#	Description
1	Feed
2	Antenna Tuning
3	Dummy Pad
4	Dummy Pad
5	Antenna Tuning
6	Dummy Pad
7	Dummy Pad
8	Dummy Pad

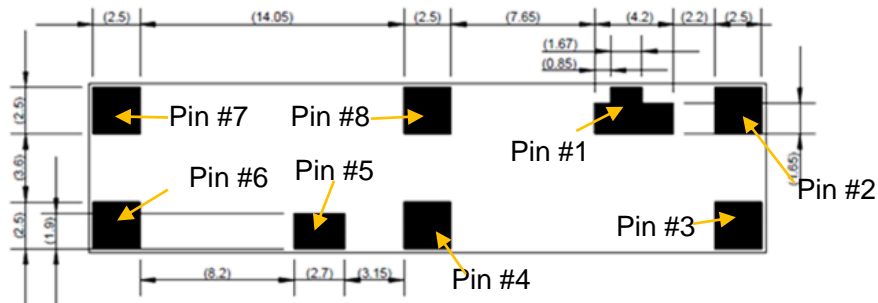

**Bottom View**

1004795 / 1004796 Embedded 5G / LTE / NTN / GNSS KYOCERA AVX SMT Antenna Specifications.  
 KYOCERA AVX produces a wide variety of standard and custom antennas to meet user needs.

**Antenna Dimensions (1004796)**

Typical antenna dimensions (mm)

Part Number	A	B	C
1004796	36.0 ± 0.2	9.0 ± 0.2	3.2 ± 0.33

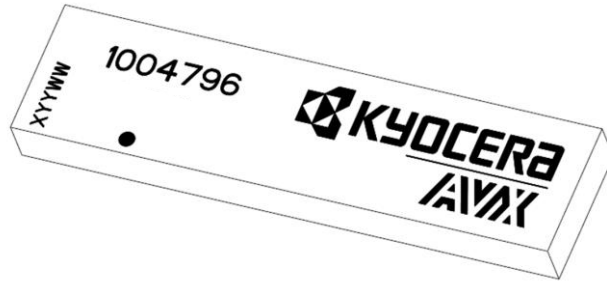

**Top View**



**Front View/Height**

Pin#	Description
1	Feed
2	Antenna Tuning
3	Dummy Pad
4	Dummy Pad
5	Antenna Tuning
6	Dummy Pad
7	Dummy Pad
8	Dummy Pad

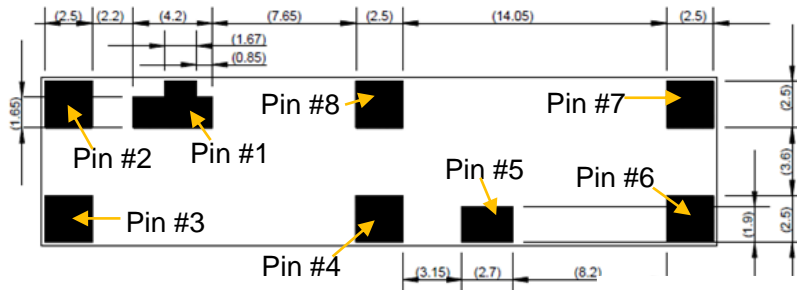

**Bottom View**

1004795 / 1004796 Embedded 5G / LTE / NTN / GNSS KYOCERA AVX SMT Antenna Specifications.  
KYOCERA AVX produces a wide variety of standard and custom antennas to meet user needs.

### VSWR and Efficiency Plots

Typical 1004795/1004796 performance 125 x 45 mm PCB

**Low Band VSWR**

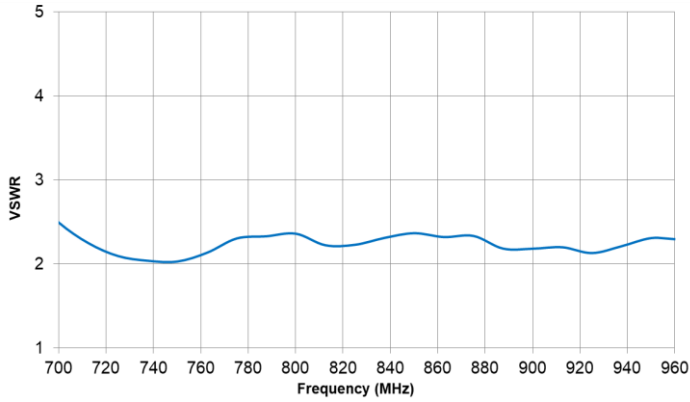

**Low Band Efficiency**

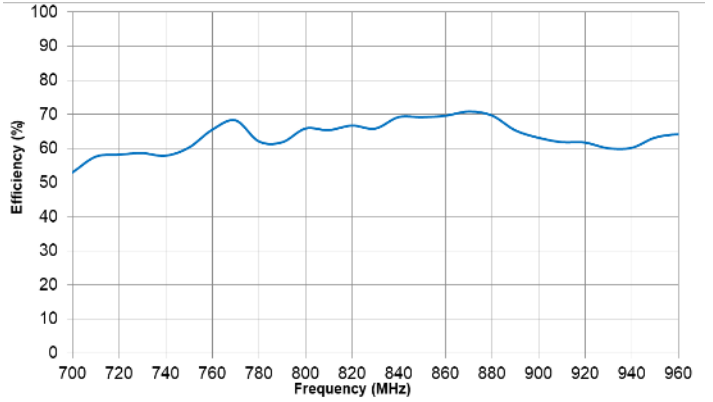

**High Band VSWR**

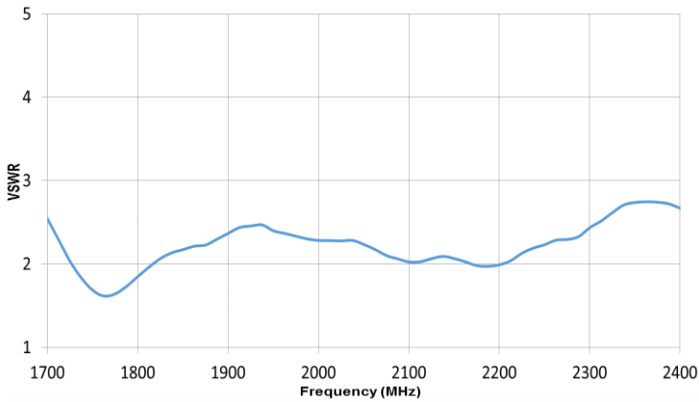

**High Band Efficiency**

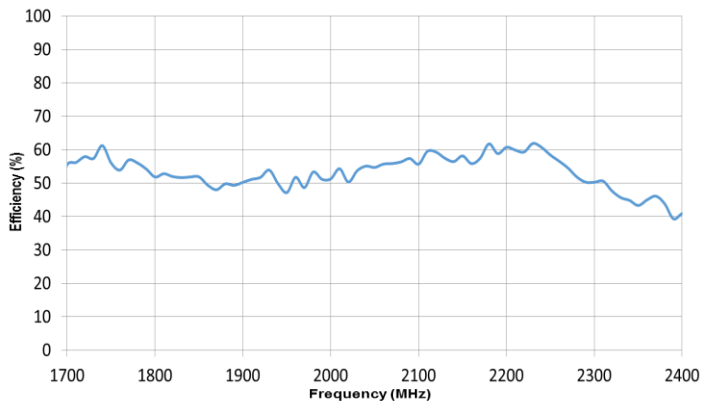

**Band 7 VSWR**

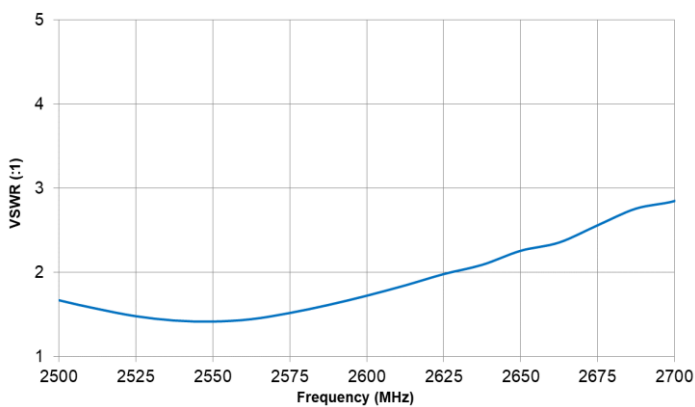

**Band 7 Efficiency**

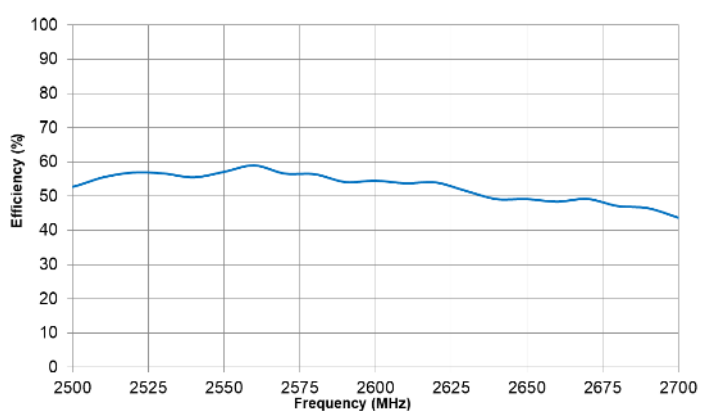

1004795 / 1004796 Embedded 5G / LTE / NTN / GNSS KYOCERA AVX SMT Antenna Specifications.  
KYOCERA AVX produces a wide variety of standard and custom antennas to meet user needs.

### Antenna Radiation Patterns – Low / High Band

Typical 1004795/1004796 performance 125 x 45 mm PCB

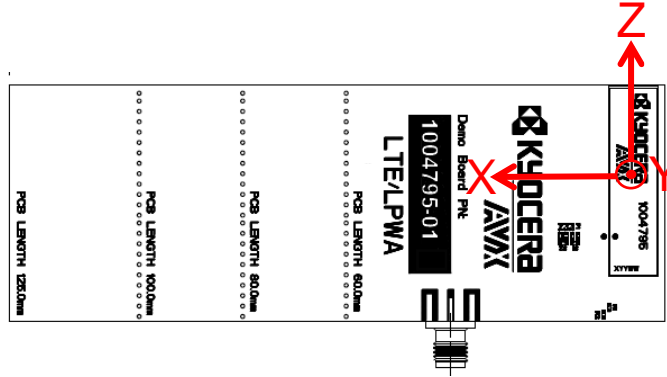

Low Band measured at  
700, 750, 850, 900 MHz

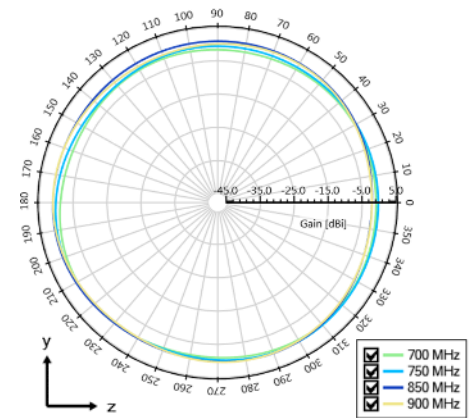
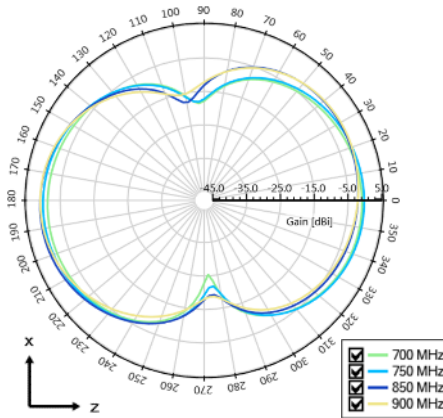
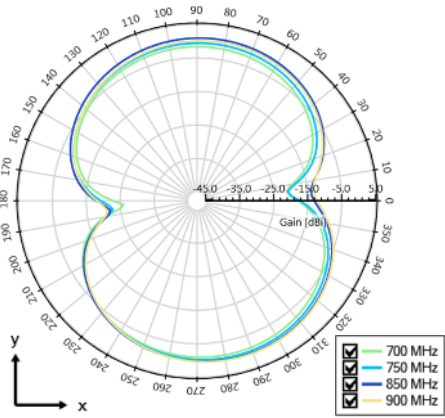

High Band measured at  
1800, 1900, 2100 MHz

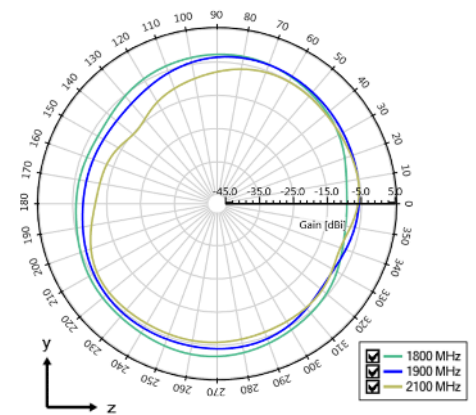
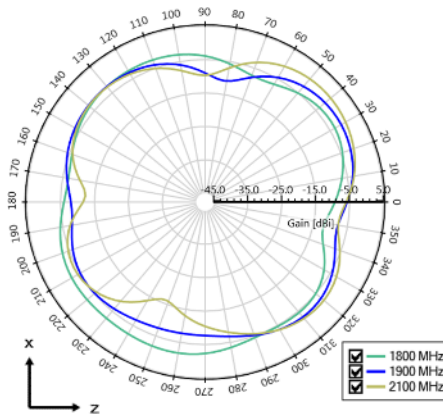
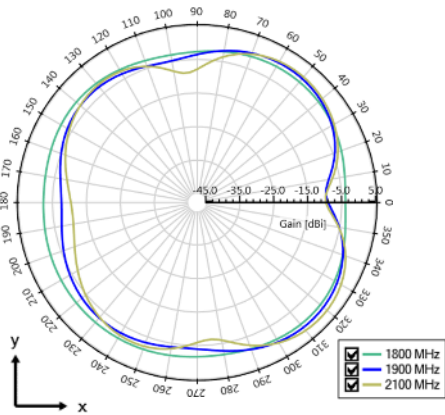

1004795 / 1004796 Embedded 5G / LTE / NTN / GNSS KYOCERA AVX SMT Antenna Specifications.  
KYOCERA AVX produces a wide variety of standard and custom antennas to meet user needs.

### Antenna Radiation Patterns – High Band, Band 7

Typical 1004795/1004796 performance 125 x 45 mm PCB

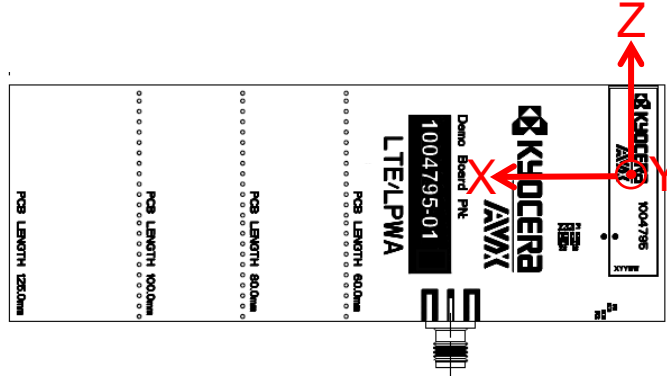

High Band measured at 2350 MHz

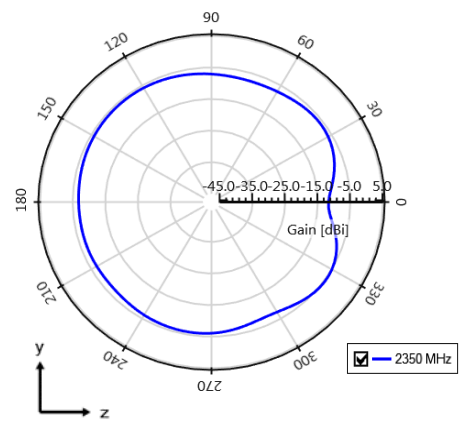
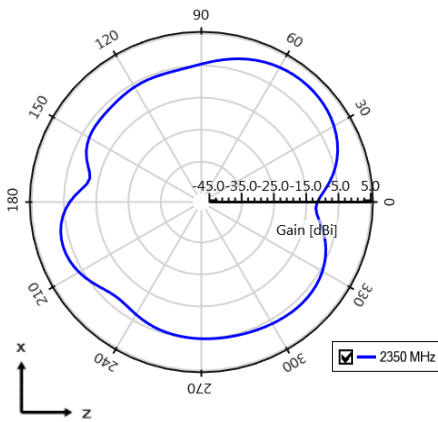
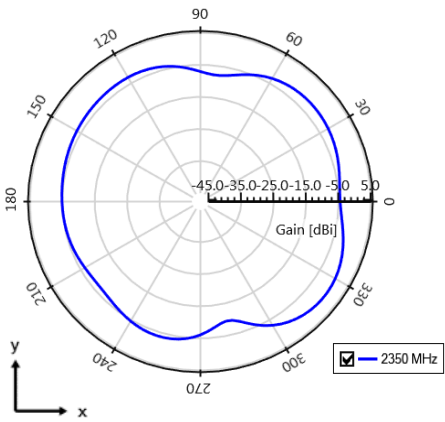

Band 7 measured at 2600 MHz

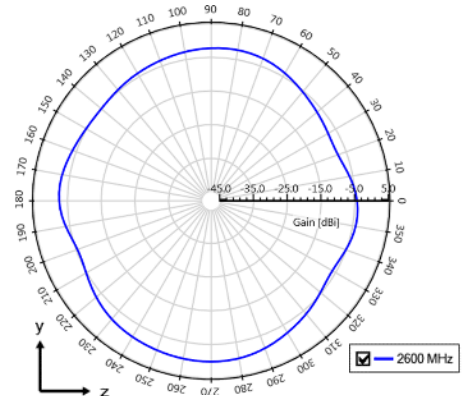
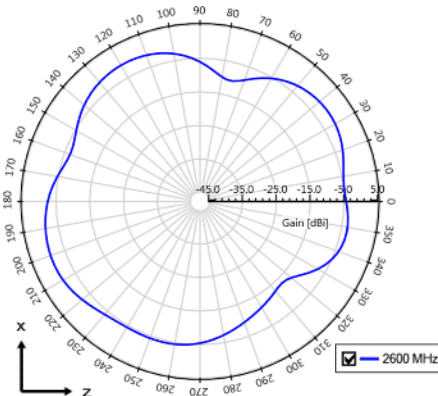
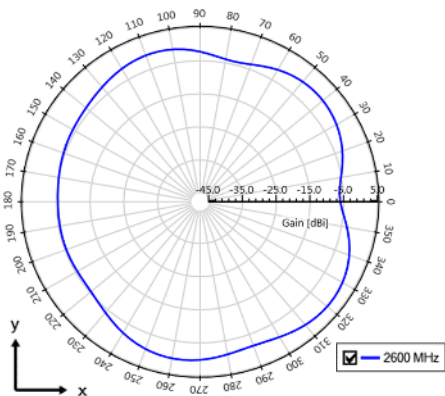



**1004795 / 1004796 Embedded 5G / LTE / NTN / GNSS KYOCERA AVX SMT Antenna Specifications.**  
 KYOCERA AVX produces a wide variety of standard and custom antennas to meet user needs.

**Antenna Layout (1004795)**

Typical layout dimensions (mm)

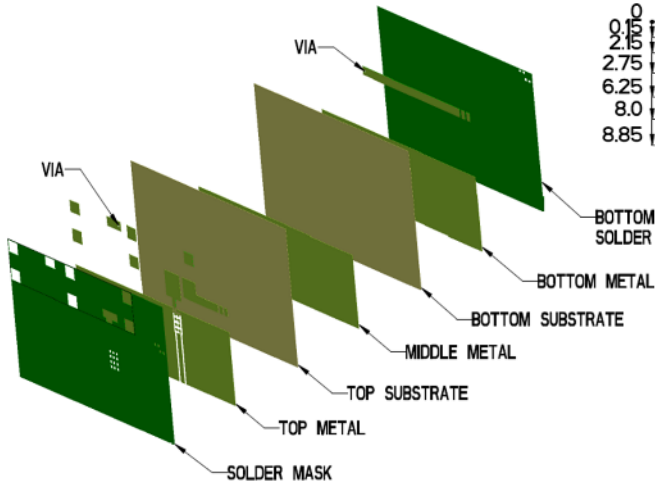

- Additional VIAS: Diam. 0.4mm to be placed around antenna, (no vias on transmission lines).
- Via holes must be covered by solder mask

**Pin Descriptions**

Pin#	Description
1	Feed
2	Antenna Tuning
3	Dummy Pad
4	Dummy Pad
5	Antenna Tuning
6	Dummy Pad
7	Dummy Pad
8	Dummy Pad

\*1004796 uses the same layout but mirrored.

Default Pi Matching Network values with instructions can be found under Antenna Matching Network.

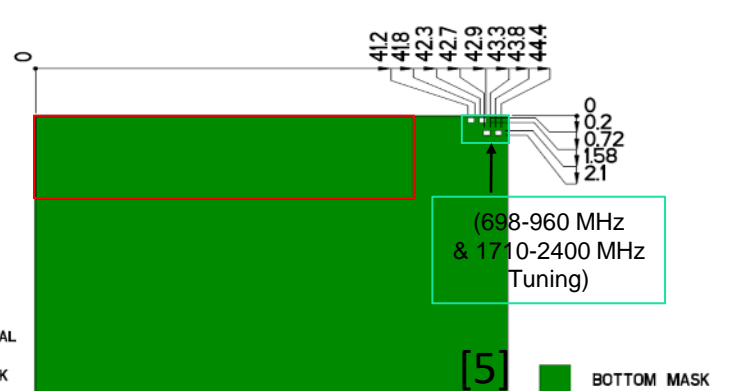
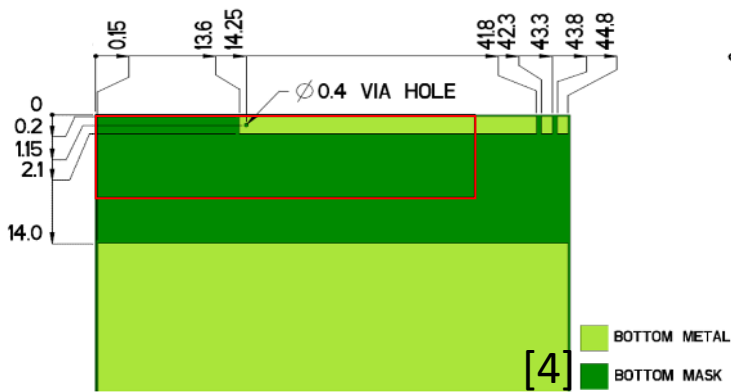
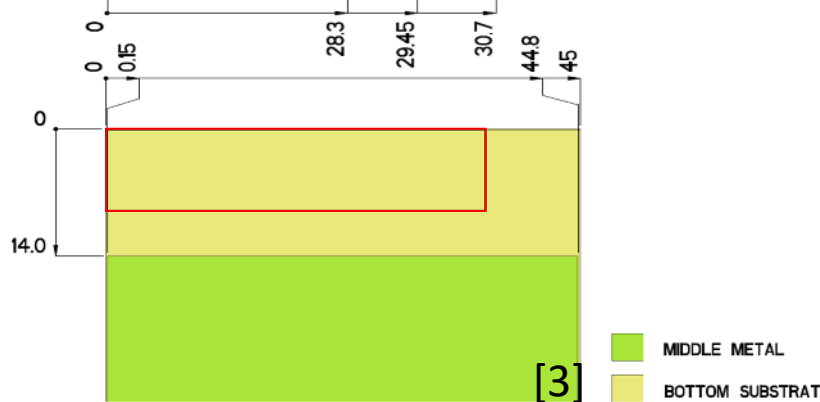
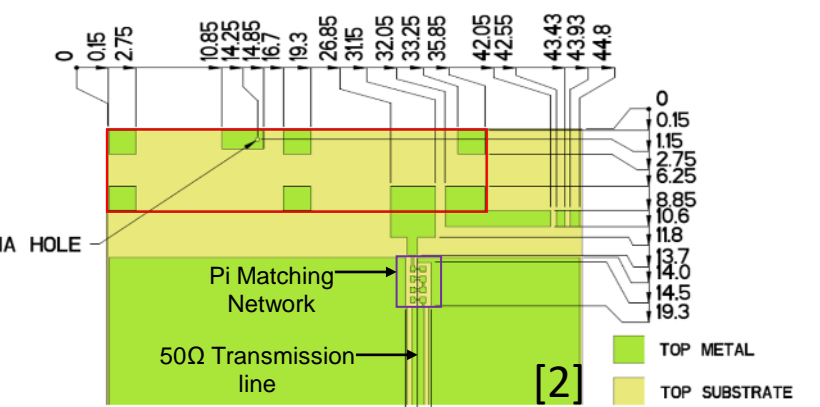
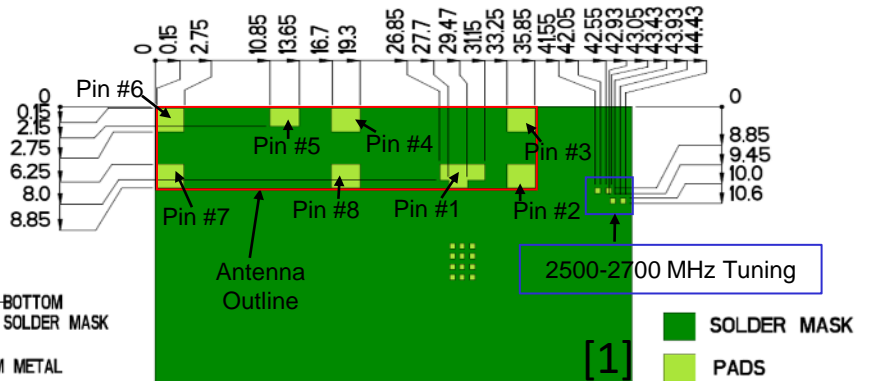

1004795 / 1004796 Embedded 5G / LTE / NTN / GNSS KYOCERA AVX SMT Antenna Specifications.  
KYOCERA AVX produces a wide variety of standard and custom antennas to meet user needs.

### Antenna Layout (1004796)

Typical layout dimensions (mm)

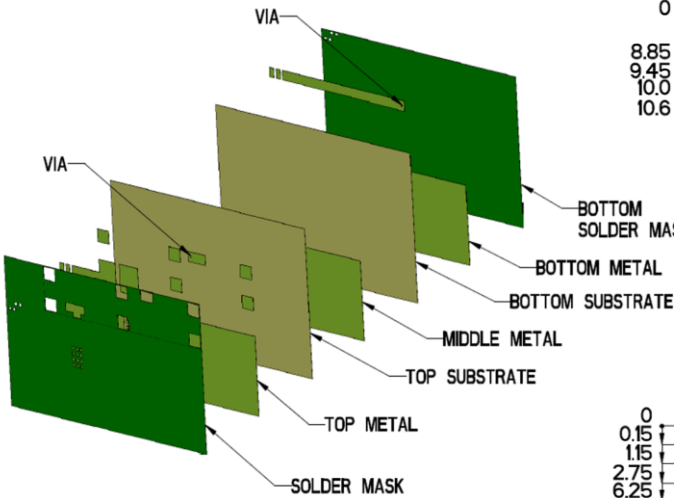

- Additional VIAS: Diam. 0.4mm to be placed around antenna, (no vias on transmission lines).
- Via holes must be covered by solder mask

### Pin Descriptions

Pin#	Description
1	Feed
2	Antenna Tuning
3	Dummy Pad
4	Dummy Pad
5	Antenna Tuning
6	Dummy Pad
7	Dummy Pad
8	Dummy Pad

\*1004795 uses the same layout but mirrored.

Default Pi Matching Network values with instructions can be found under Antenna Matching Network.

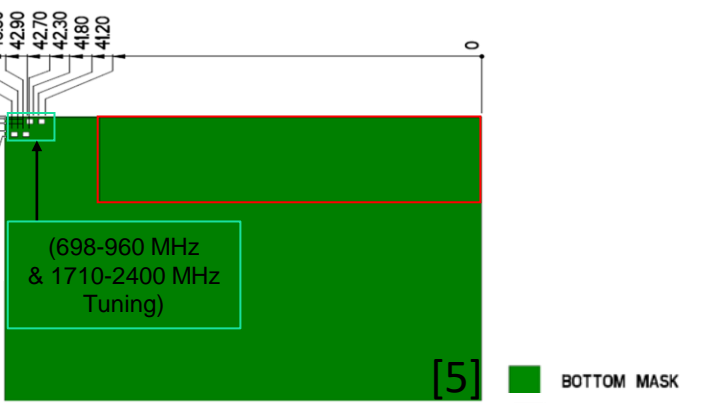
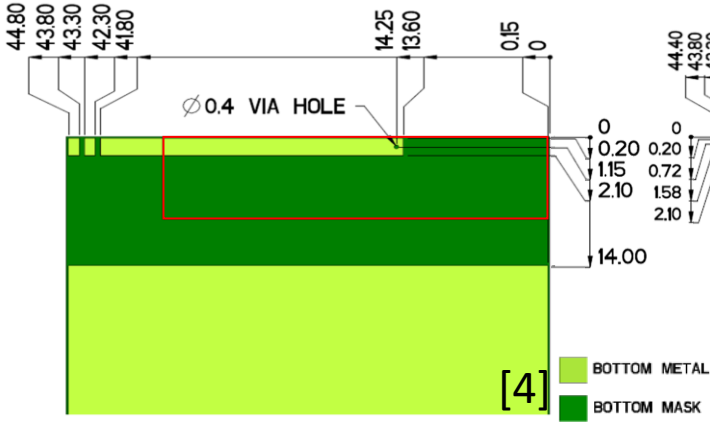
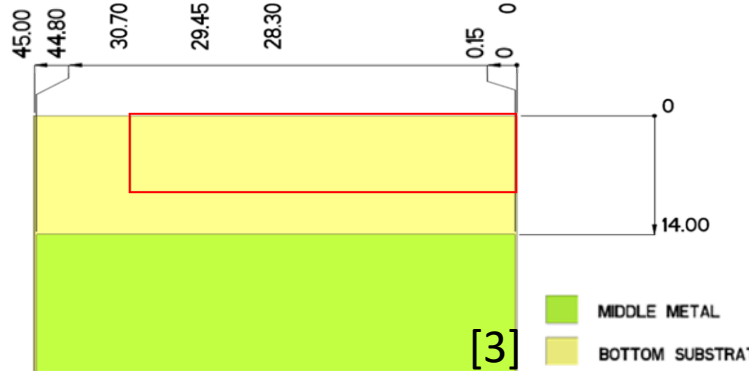
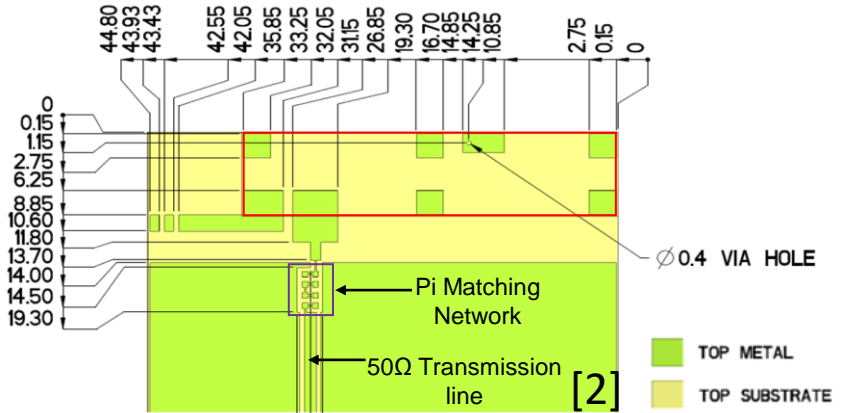
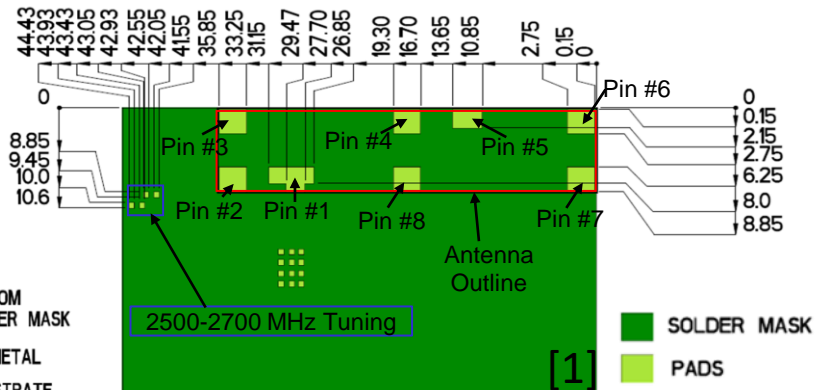

1004795 / 1004796 Embedded 5G / LTE / NTN / GNSS KYOCERA AVX SMT Antenna Specifications.  
 KYOCERA AVX produces a wide variety of standard and custom antennas to meet user needs.

### Antenna Matching Structure (1004795)

Typical matching values on 125 x 45 mm PCB  
 \*Also applies to mirrored layout 1004796

Demo Board Front View

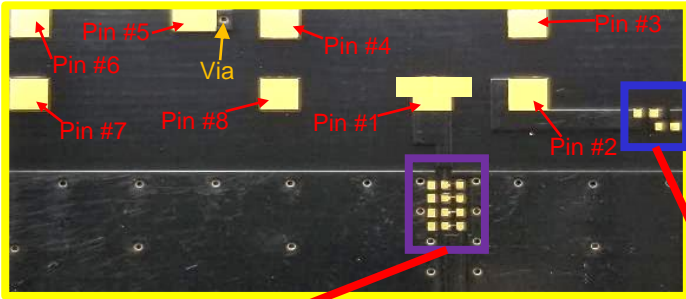

Demo Board Back View

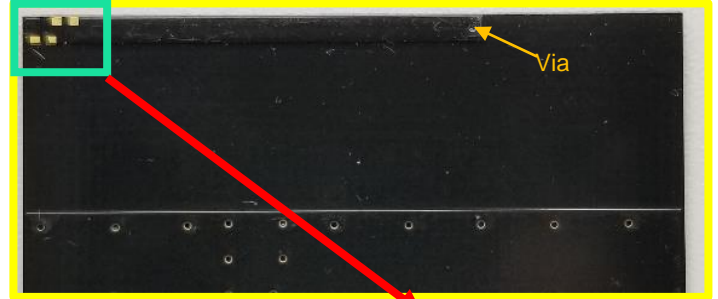

Antenna Matching

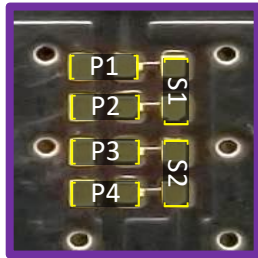

(Antenna Matching):  
 pads are directly inline with  
 the antenna feed trace.

2500-2700 MHz Tuning

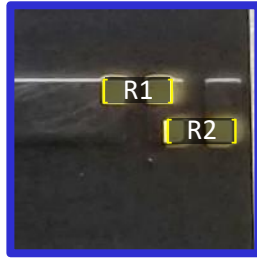

698-960 MHz & 1710-2400 MHz Tuning

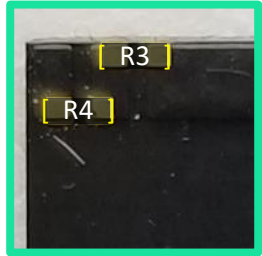

#### Pin Descriptions

Pin#	Description
1	Feed
2	Antenna Tuning
3	Dummy Pad
4	Dummy Pad
5	Antenna Tuning
6	Dummy Pad
7	Dummy Pad
8	Dummy Pad

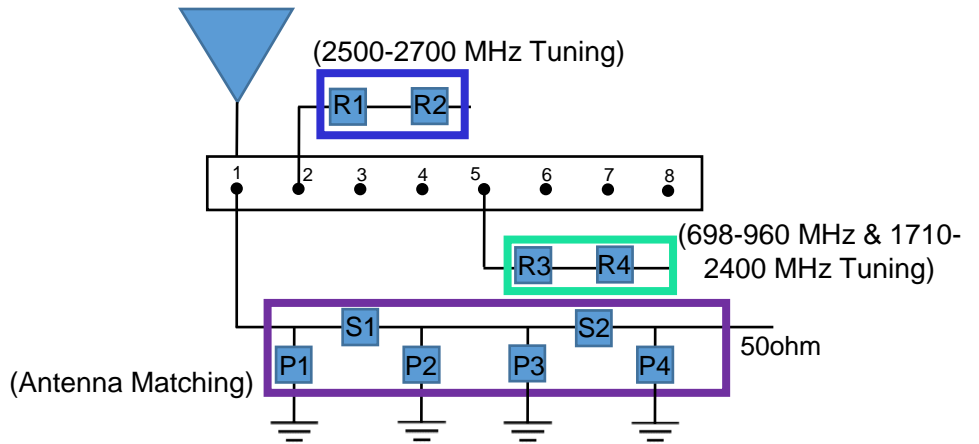

	P1	S1	P2	P3	S2	P4	R1	R2	R3-R4
<b>Default Matching</b>	8.2nH	4.7pF	0.3pF	N/A	0 Ohm	0.5pF	0 Ohm	N/A	0 Ohm
<b>Tolerance</b>	± 0.1nH	± 0.05pF	± 0.05pF	N/A	N/A	± 0.05pF	N/A	N/A	N/A

1004795 / 1004796 Embedded 5G / LTE / NTN / GNSS KYOCERA AVX SMT Antenna Specifications.  
 KYOCERA AVX produces a wide variety of standard and custom antennas to meet user needs.

**Antenna Tuning Options (1004795)**

Typical matching values on 125 x 45 mm PCB

\*Also applies to mirrored layout 1004796

Demo Board Front View

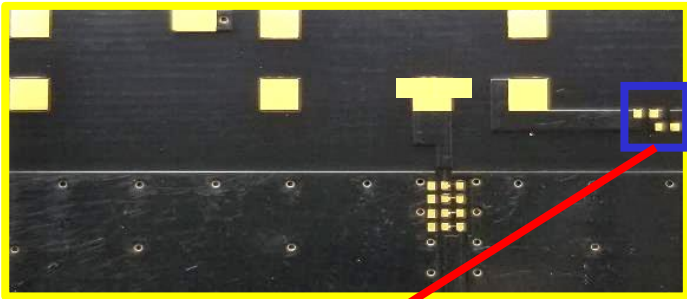

Demo Board Back View

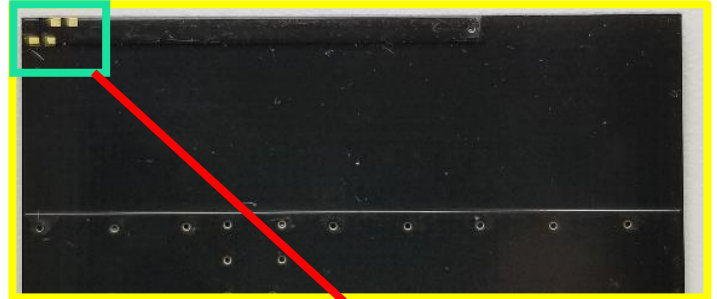

2500-2700 MHz Tuning

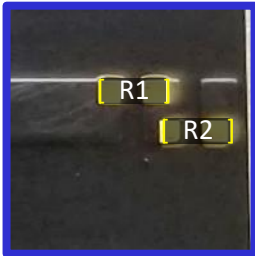

698-960 MHz  
& 1710-2400 MHz Tuning

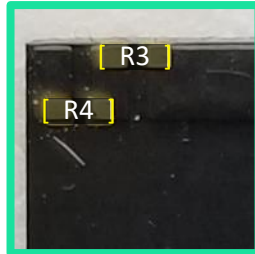

Options for Tuning: "698-960 MHz & 1710-2400 MHz"

MODE	T1	T2		T3	
PADS	Connect: R3 & R4	Remove: R4		Remove: R4 & R3	
Outcome: (Ref: Baseline)	BASELINE	(698-960 MHz) ~20 MHz shift high	(1710-2400 MHz) ~20 MHz shift high	(698-960 MHz) ~30 MHz shift high	(1710-2400 MHz) ~35 MHz shift high

\*R= 0 Ohm

Options for Tuning: "2500-2700 MHz"

MODE	T4	T5	T6
PADS	Connect: R1	Connect: R1 & R2	Remove: R1 & R2
Outcome: (Ref: Baseline)	BASELINE	~60 MHz shift low	~70 MHz shift high

\*R= 0 Ohm

1004795 / 1004796 Embedded 5G / LTE / NTN / GNSS KYOCERA AVX SMT Antenna Specifications.  
 KYOCERA AVX produces a wide variety of standard and custom antennas to meet user needs.

**Antenna Demo Board (1004795-01)**

Demo Board Front/Back View (mm)

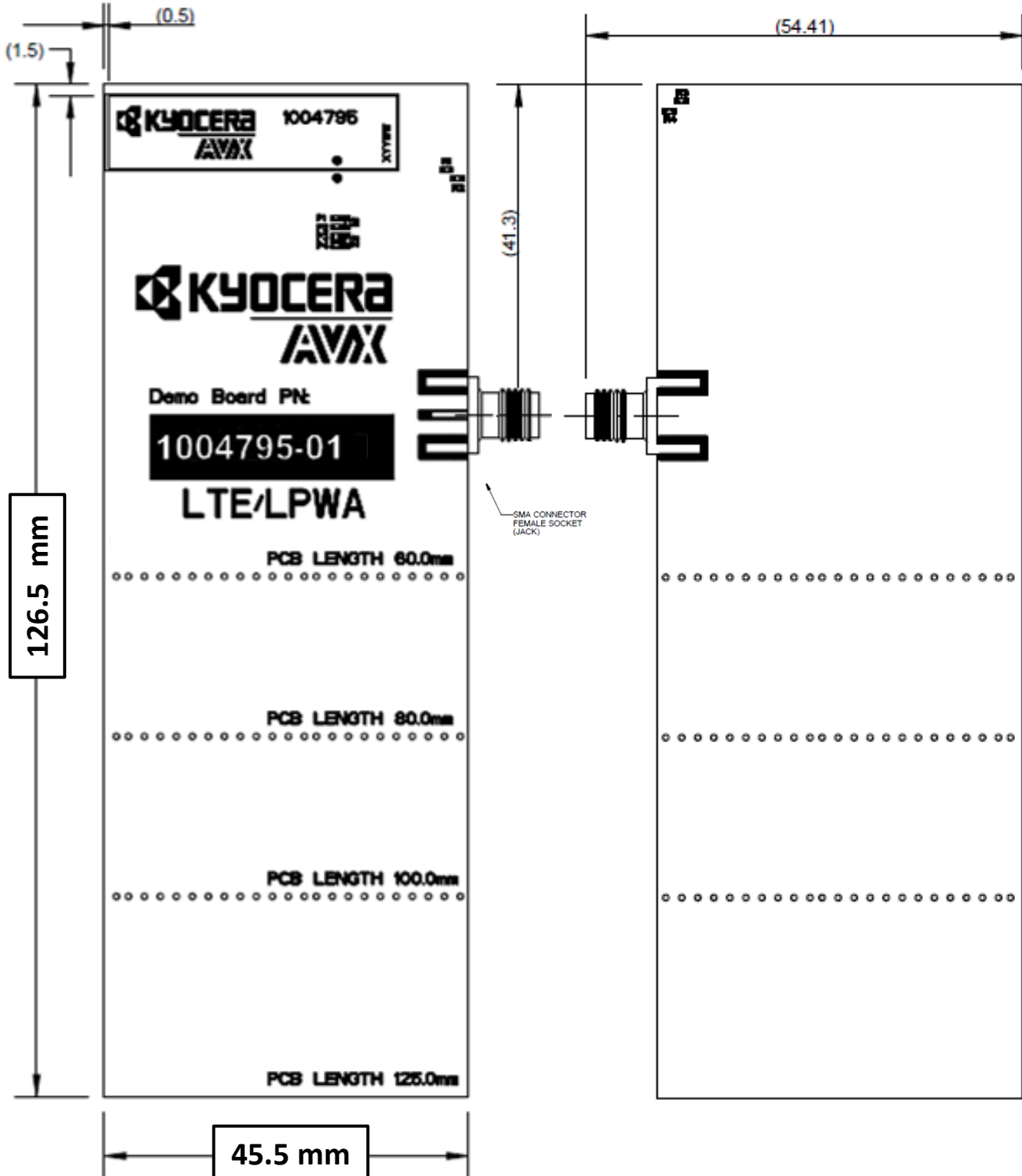

1004795 / 1004796 Embedded 5G / LTE / NTN / GNSS KYOCERA AVX SMT Antenna Specifications.  
 KYOCERA AVX produces a wide variety of standard and custom antennas to meet user needs.

**Antenna Demo Board (1004796-01)**

Demo Board Front/Back View (mm)

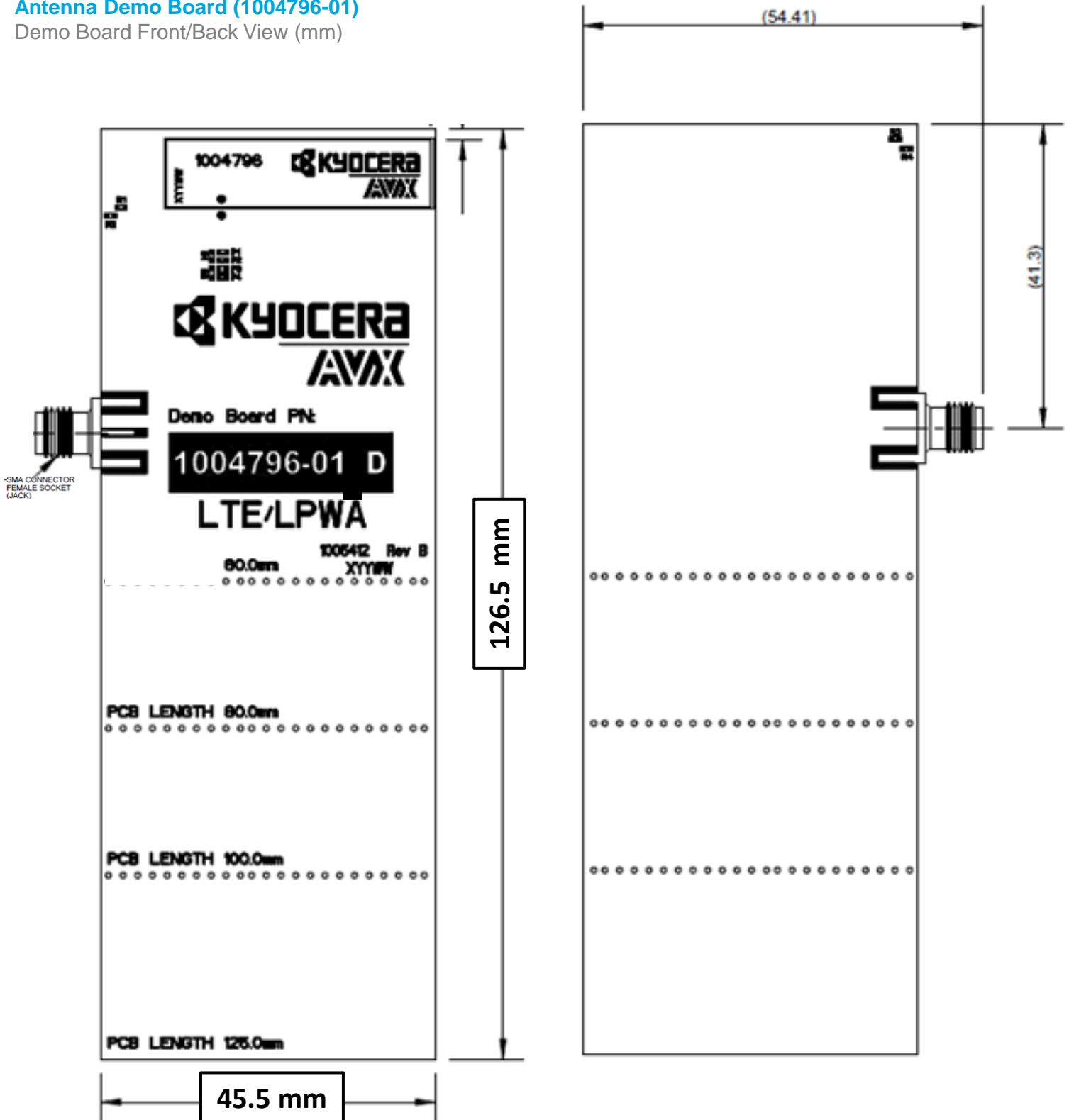

1004795 / 1004796 Embedded 5G / LTE / NTN / GNSS KYOCERA AVX SMT Antenna Specifications.  
 KYOCERA AVX produces a wide variety of standard and custom antennas to meet user needs.

# Appendix 1

Appendix 1 gives instructions on how to achieve coverage at low frequency through impedance matching network.

(315 MHz / 400 MHz / 433 MHz / 450 MHz )

Frequency (MHz)	315	400	433	450
Peak Gain	-3.0 dBi	-3.0 dBi	-1.8 dBi	-3.0 dBi
Average Efficiency	17%	21%	26%	23%
VSWR Match	< 1.5:1			
Polarization	Linear			
Power Handling	2 Watt CW			
Feed Point Impedance	50 Ω unbalanced			

\*Data shown above has Appendix 1 matching applied on 125 x 45 mm pcb.

1004795 / 1004796 Embedded 5G / LTE / NTN / GNSS KYOCERA AVX SMT Antenna Specifications.  
 KYOCERA AVX produces a wide variety of standard and custom antennas to meet user needs.

**Appendix 1: Antenna Matching Structure (1004795)**

Typical matching values on 125 x 45 mm PCB

Demo Board Front View

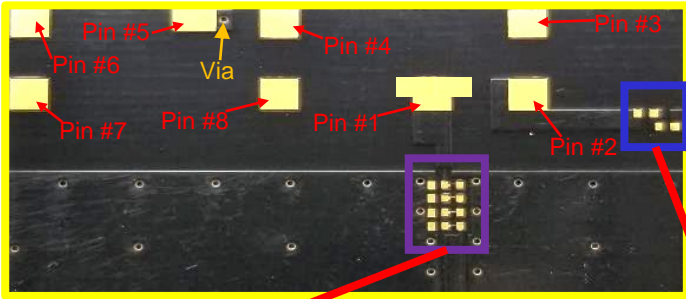

Demo Board Back View

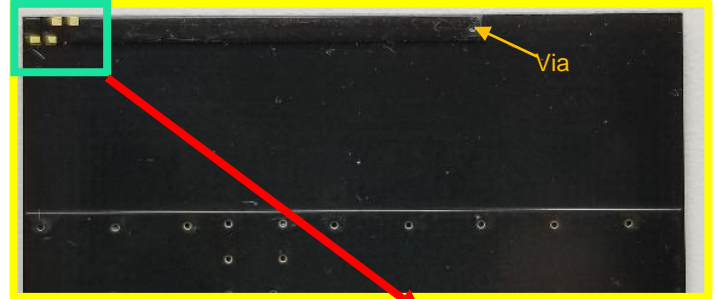

Antenna Matching

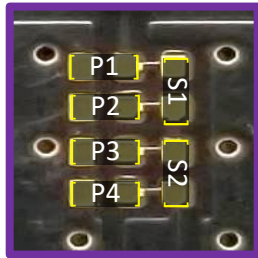

(Antenna Matching): pads are directly inline with the antenna feed trace.

Frontside Tuning

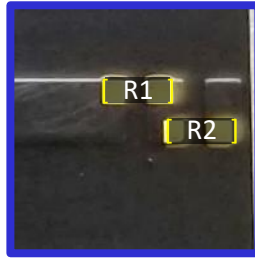

Backside Tuning

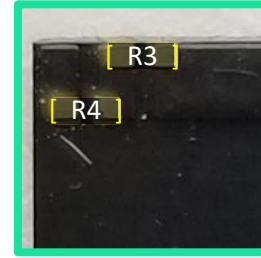

Pin Descriptions

Pin#	Description
1	Feed
2	Antenna Tuning
3	Dummy Pad
4	Dummy Pad
5	Antenna Tuning
6	Dummy Pad
7	Dummy Pad
8	Dummy Pad

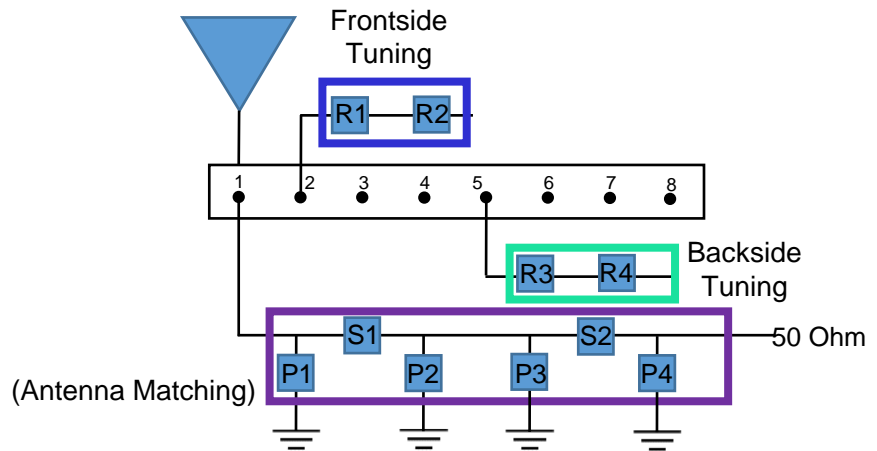

Frequency	P1	S1	P2	P3	S2	P4	R1	R2	R3-R4
315 MHz	N/A	120nH	12pF	N/A	18nH	N/A	0 Ohm	N/A	0 Ohm
400 MHz	N/A	75nH	10pF	N/A	0 Ohm	N/A	0 Ohm	N/A	0 Ohm
433 MHz	N/A	62nH	12pF	N/A	0 Ohm	N/A	0 Ohm	N/A	0 Ohm
450 MHz	N/A	56nH	12pF	N/A	0 Ohm	N/A	0 Ohm	N/A	0 Ohm



1004795 / 1004796 Embedded 5G / LTE / NTN / GNSS KYOCERA AVX SMT Antenna Specifications.  
KYOCERA AVX produces a wide variety of standard and custom antennas to meet user needs.

### Appendix 1: VSWR, Efficiency, and Peak Gain Plots

Typical 1004795 performance 125 x 45 mm PCB

**VSWR**  
(300 – 470 MHz)

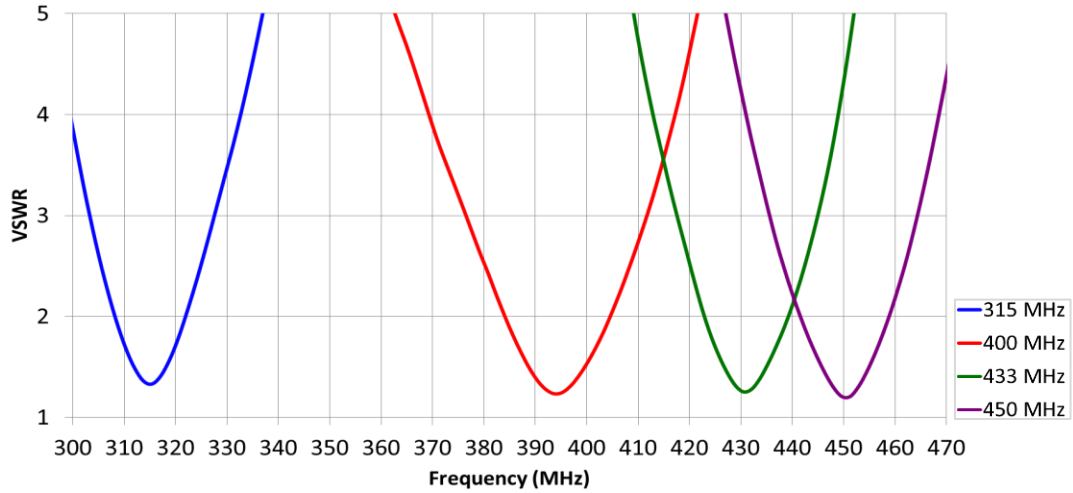

**Efficiency**  
(300 – 470 MHz)

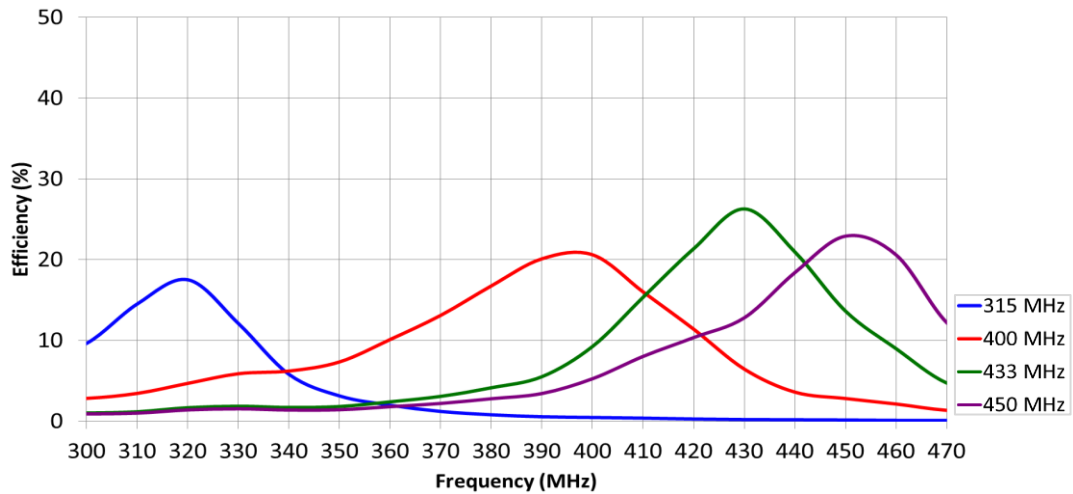

**Peak Gain**  
(300 – 470 MHz)

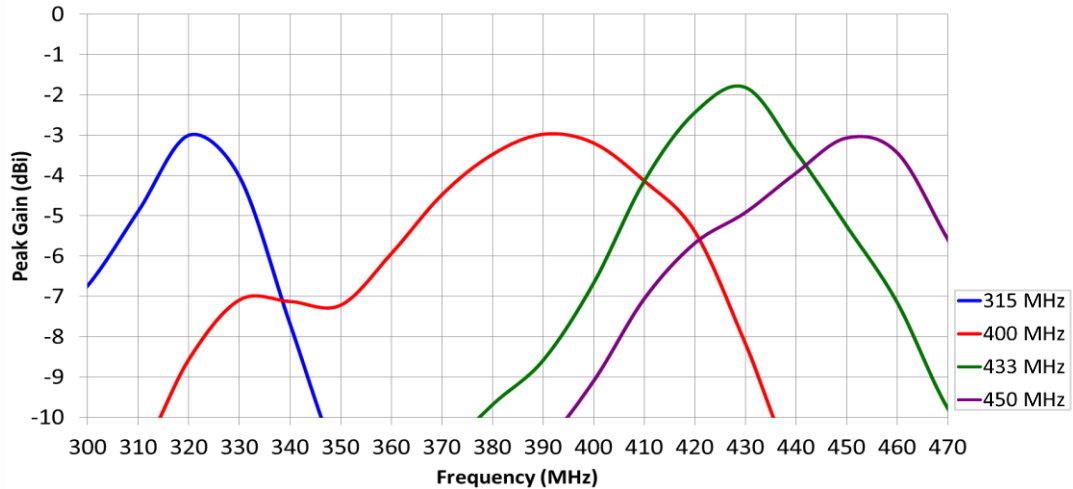

1004795 / 1004796 Embedded 5G / LTE / NTN / GNSS KYOCERA AVX SMT Antenna Specifications.  
KYOCERA AVX produces a wide variety of standard and custom antennas to meet user needs.

**Appendix 1: Antenna Radiation Patterns – 315 MHz and 400 MHz**

Typical 1004795 performance 125 x 45 mm PCB

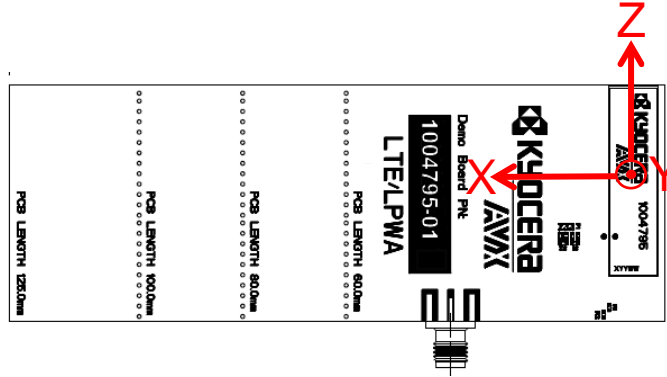

Measured at 315 MHz

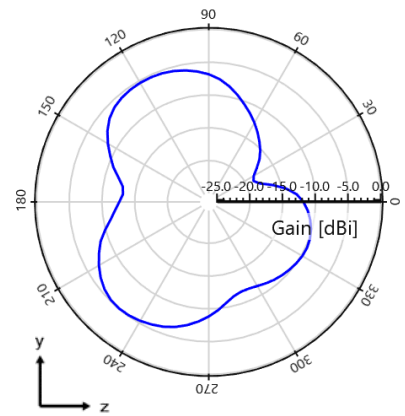
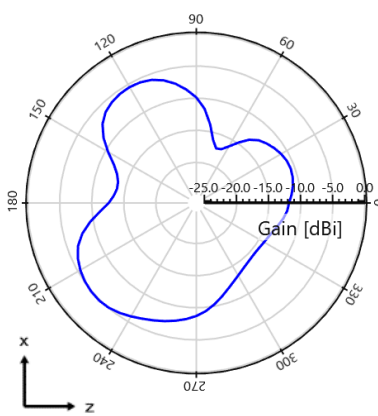
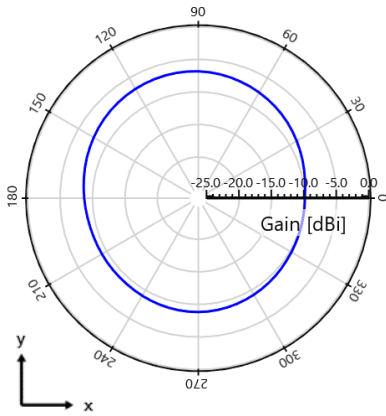

Measured at 400 MHz

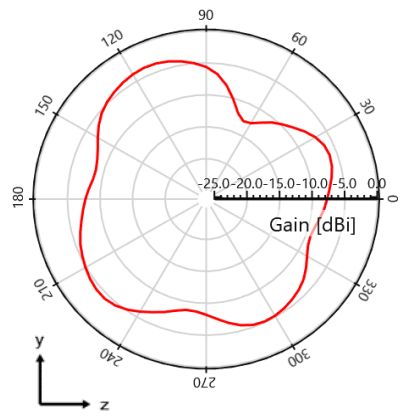
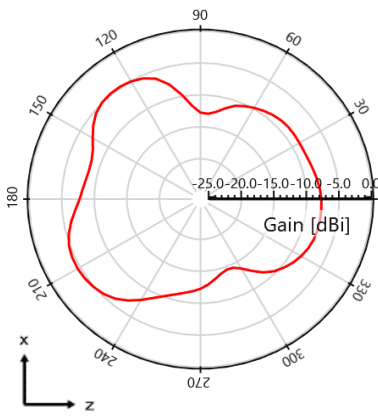
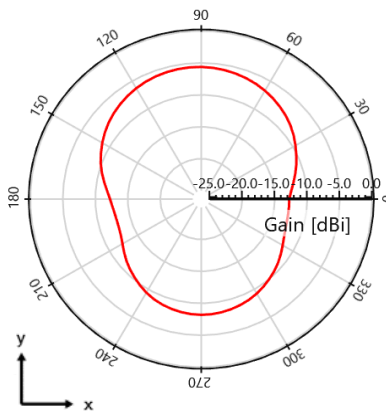

1004795 / 1004796 Embedded 5G / LTE / NTN / GNSS KYOCERA AVX SMT Antenna Specifications.  
KYOCERA AVX produces a wide variety of standard and custom antennas to meet user needs.

**Appendix 1: Antenna Radiation Patterns – 433 MHz and 450 MHz**

Typical 1004795 performance 125 x 45 mm PCB

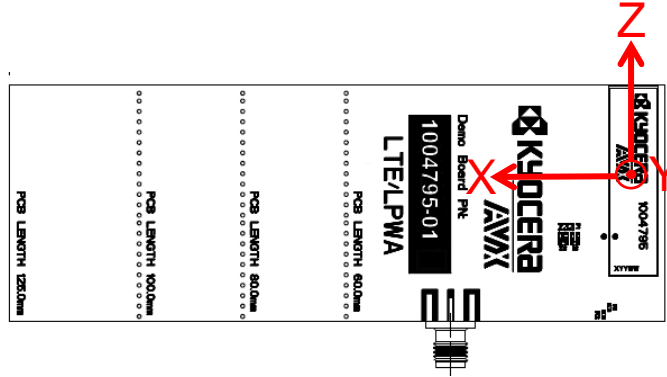

Measured at 433 MHz

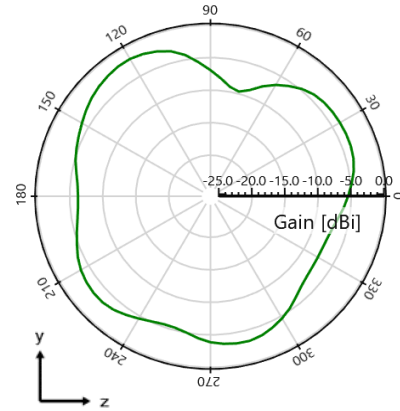
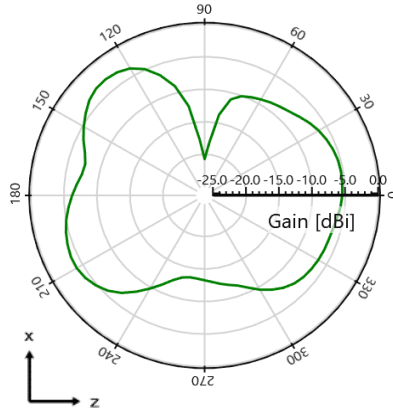
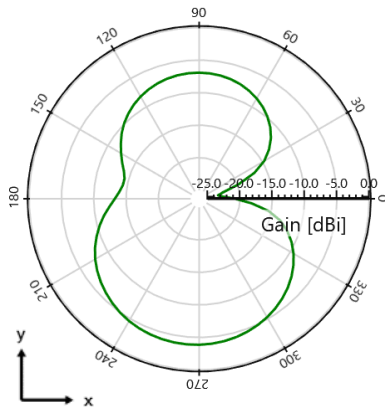

Measured at 450 MHz

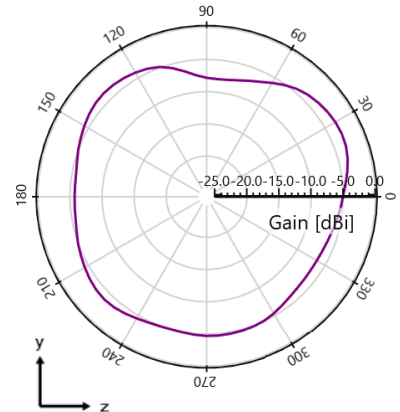
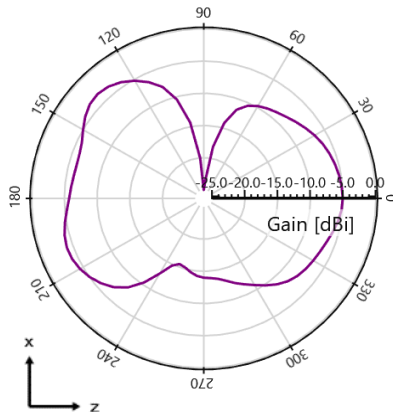
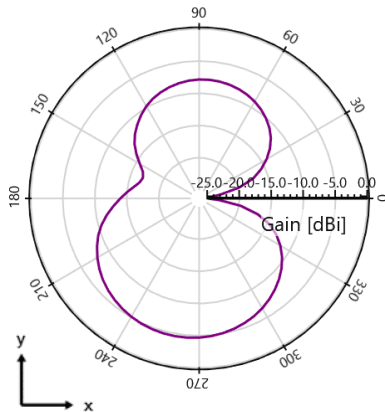

1004795 / 1004796 Embedded 5G / LTE / NTN / GNSS KYOCERA AVX SMT Antenna Specifications.  
 KYOCERA AVX produces a wide variety of standard and custom antennas to meet user needs.

# Appendix 2

Appendix 2 gives instructions on how to achieve increased bandwidth to cover **Cellular 4G/5G, NTN and GNSS Bands** through impedance matching network **in a small PCB size.**

- (699 - 960 MHz, Cellular 4G/5G)
- (1710 - 2400 MHz, Cellular 4G/5G)
- (1525 - 1660 MHz, NTN L-Band)
- (1559 - 1610 MHz, GNSS)
- (1980 - 2200 MHz, NTN S-Band)
- (2500-2700 MHz, Cellular 4G/5G)

Frequency (MHz)	699-960	1710-2400	1525-1660	1559-1610	1980-2200	2500-2700
Peak Gain	- 1.4 dBi	2.5 dBi	0.5 dBi	0.1 dBi	2.5 dBi	2 dBi
Average Efficiency	23 %	66 %	50 %	50 %	65 %	48 %
Return Loss Match	< - 3.7	< - 10	< - 6	< - 6.5	< - 9.5	< - 6
Polarization	Linear					
Power Handling	2 Watt CW					
Feed Point Impedance	50 Ω unbalanced					
Radiation Pattern	Omni-directional					

\*Data shown above has Appendix 2 matching applied on 60 x 45 mm PCB.

1004795 / 1004796 Embedded 5G / LTE / NTN / GNSS KYOCERA AVX SMT Antenna Specifications.  
 KYOCERA AVX produces a wide variety of standard and custom antennas to meet user needs.

### Appendix 2: Antenna Matching Structure (1004795)

Typical matching values on 60 x 45 mm PCB

\*Also applies to mirrored layout 1004796

Demo Board Front View

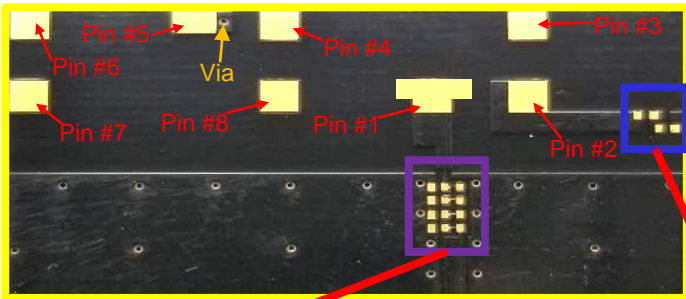

Demo Board Back View

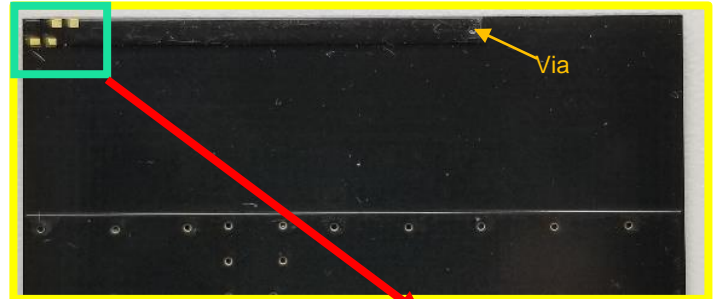

Antenna Matching

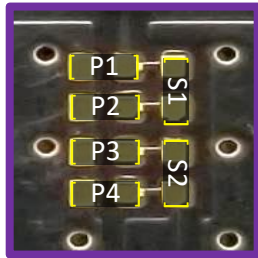

(Antenna Matching): pads are directly inline with the antenna feed trace.

2500-2700 MHz Tuning

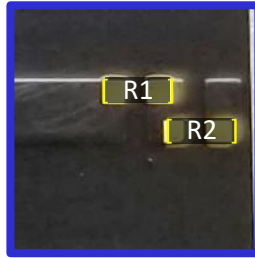

700-960 MHz & 1710-2400 MHz Tuning

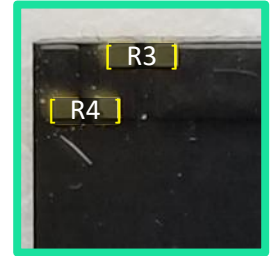

#### Pin Descriptions

Pin#	Description
1	Feed
2	Antenna Tuning
3	Dummy Pad
4	Dummy Pad
5	Antenna Tuning
6	Dummy Pad
7	Dummy Pad
8	Dummy Pad

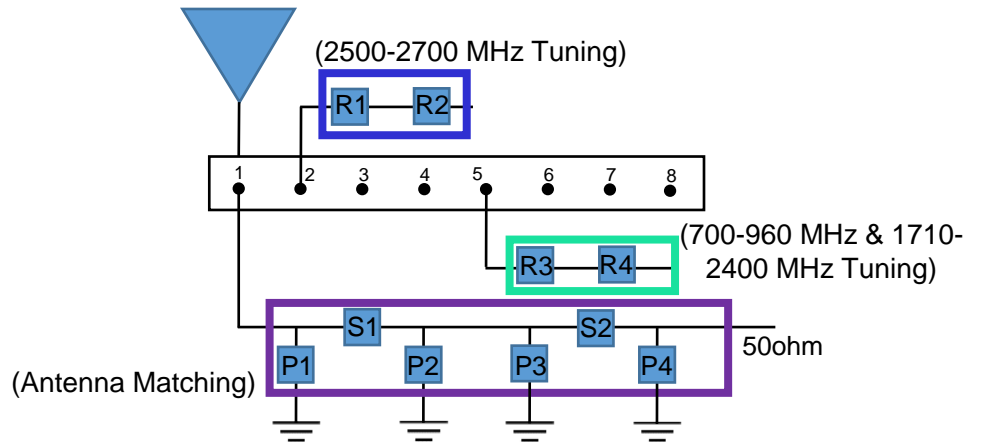

	P1	S1	P2	P3	S2	P4	R1	R2	R3-R4
<b>Default Matching</b>	8.2nH	4.7pF	0.3pF	N/A	0 Ohm	0.5pF	0 Ohm	N/A	0 Ohm
<b>Tolerance</b>	± 0.1nH	± 0.05pF	± 0.05pF	N/A	N/A	± 0.05pF	N/A	N/A	N/A

1004795 / 1004796 Embedded 5G / LTE / NTN / GNSS KYOCERA AVX SMT Antenna Specifications.  
 KYOCERA AVX produces a wide variety of standard and custom antennas to meet user needs.

## Appendix 2: Return Loss Data

Typical 1004795 performance 60 x 45 mm PCB

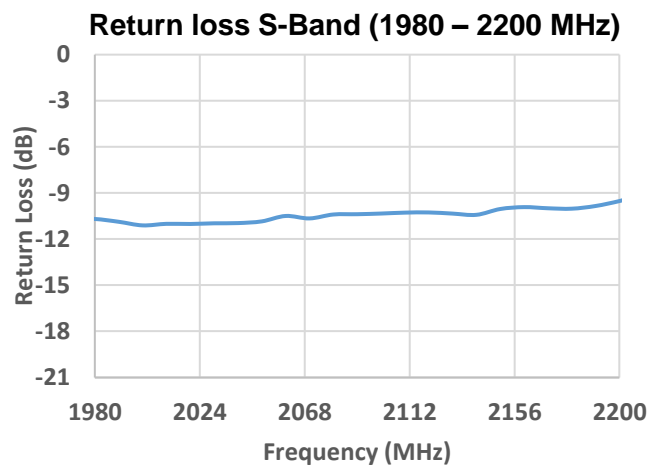
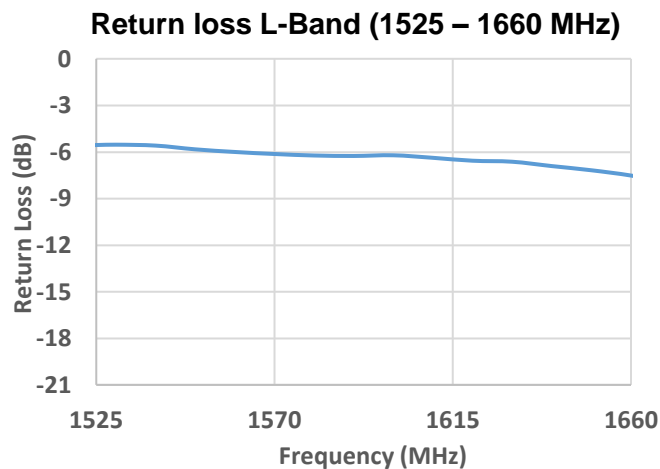
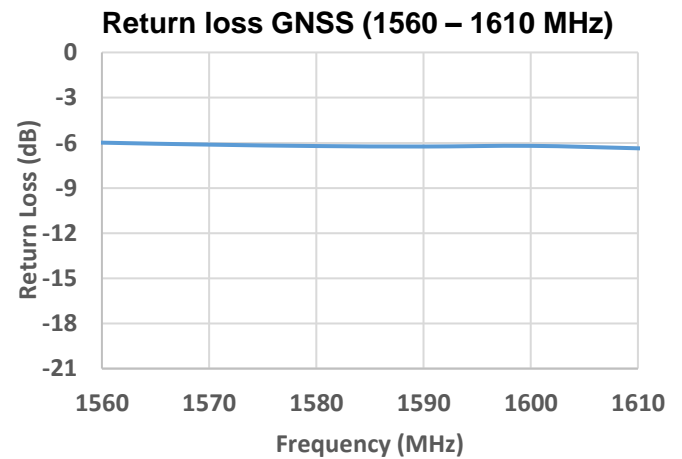
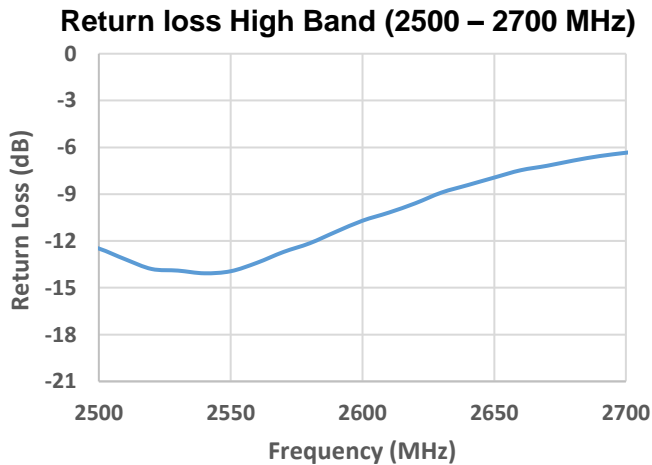
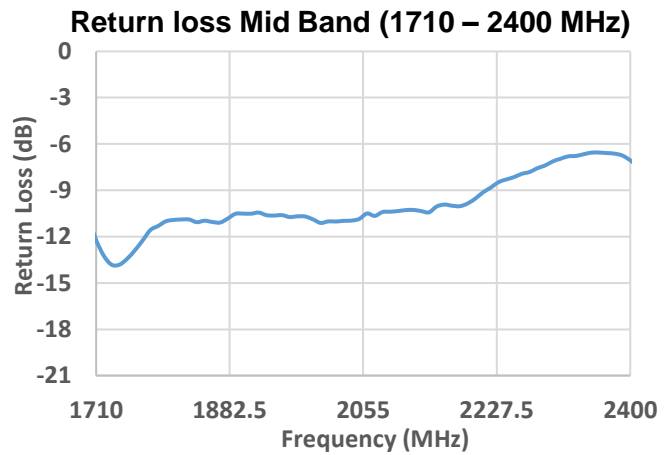
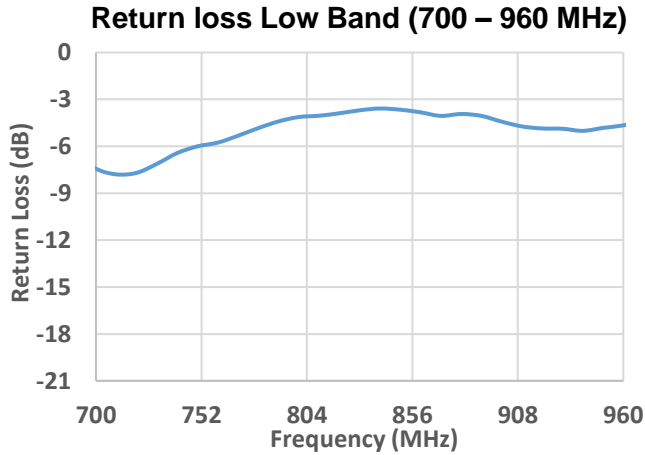

1004795 / 1004796 Embedded 5G / LTE / NTN / GNSS KYOCERA AVX SMT Antenna Specifications.  
 KYOCERA AVX produces a wide variety of standard and custom antennas to meet user needs.

### Appendix 2: Efficiency Data

Typical 1004795 performance 60 x 45 mm PCB

**Efficiency Low Band (700 – 960 MHz)**

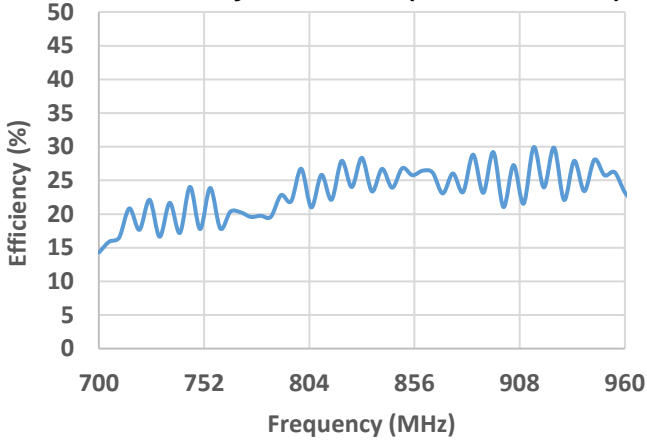

**Efficiency Mid Band (1710 – 2400 MHz)**

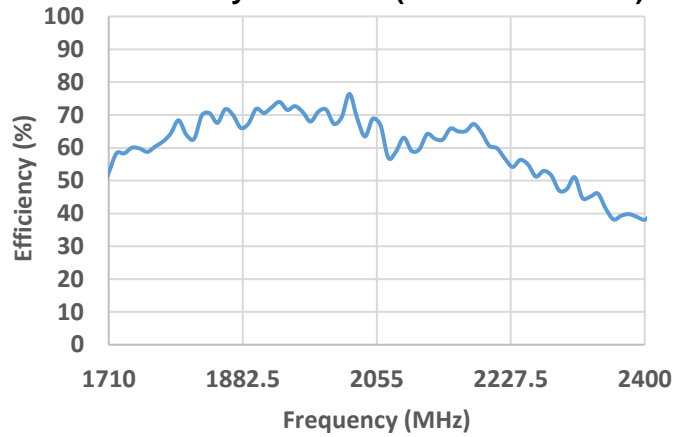

**Efficiency High Band (2500 – 2700 MHz)**

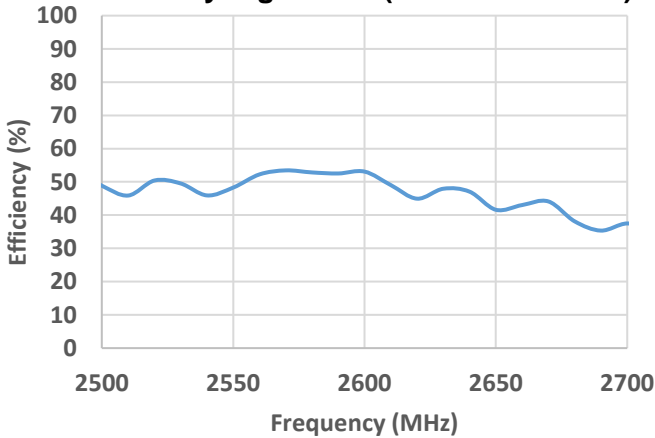

**Efficiency GNSS (1560 – 1610 MHz)**

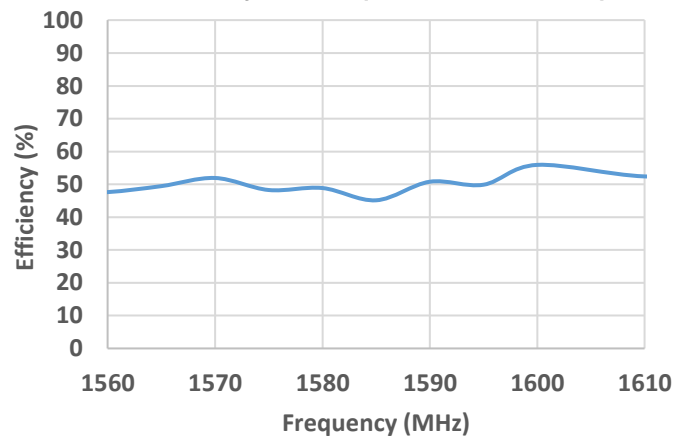

**Efficiency L-Band (1525 – 1660 MHz)**

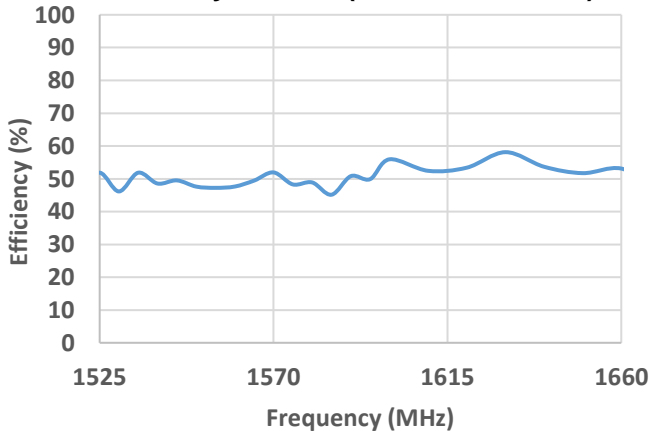

**Efficiency S-Band (1980 – 2200 MHz)**

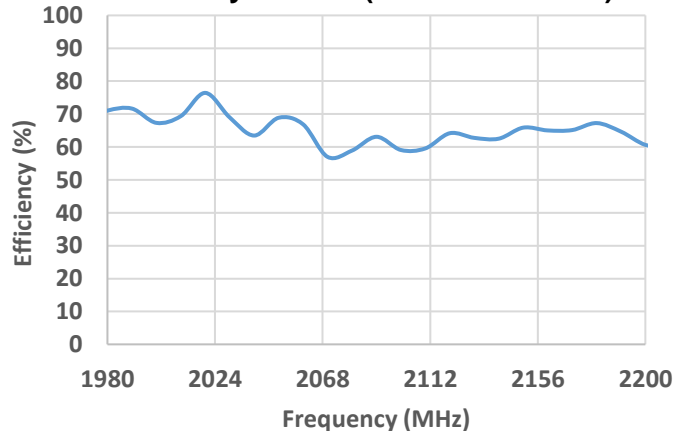

1004795 / 1004796 Embedded 5G / LTE / NTN / GNSS KYOCERA AVX SMT Antenna Specifications.  
 KYOCERA AVX produces a wide variety of standard and custom antennas to meet user needs.

### Appendix 2: Peak Gain Data

Typical 1004795 performance 60 x 45 mm PCB

**Peak Gain Low Band (700 – 960 MHz)**

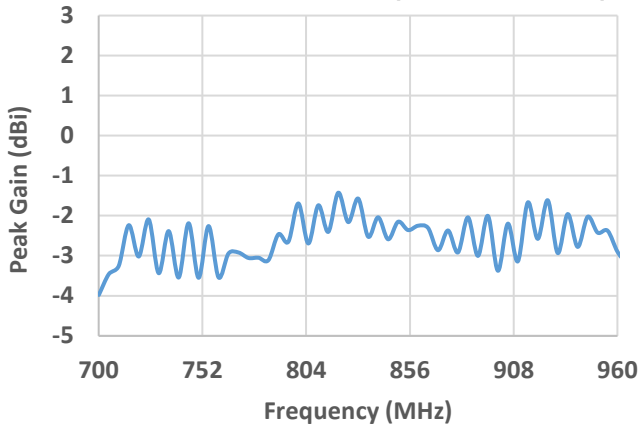

**Peak Gain Mid Band (1710 – 2400 MHz)**

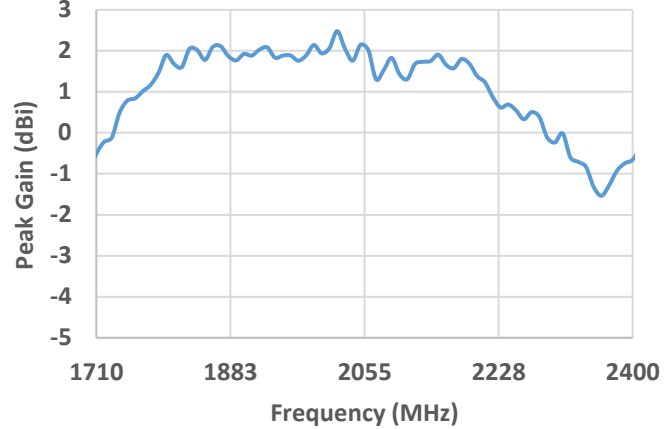

**Peak Gain High Band (2500 – 2700 MHz)**

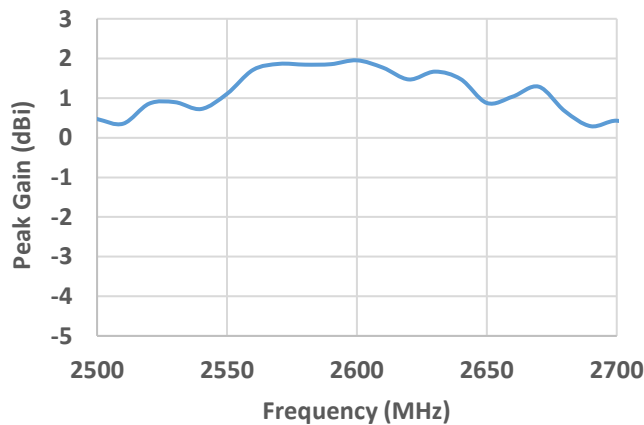

**Peak Gain GNSS (1560 – 1610 MHz)**

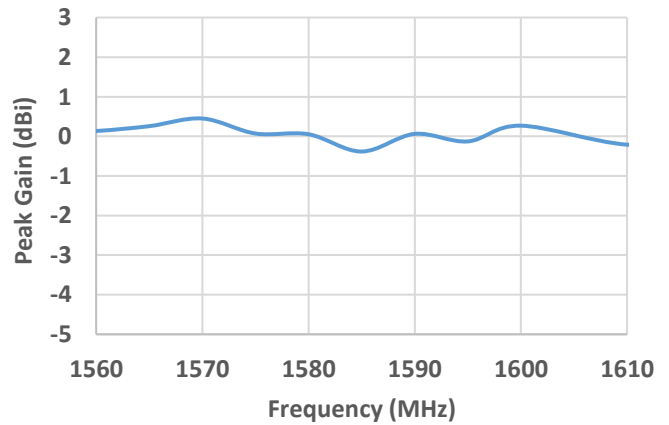

**Peak Gain L-Band (1525 – 1660 MHz)**

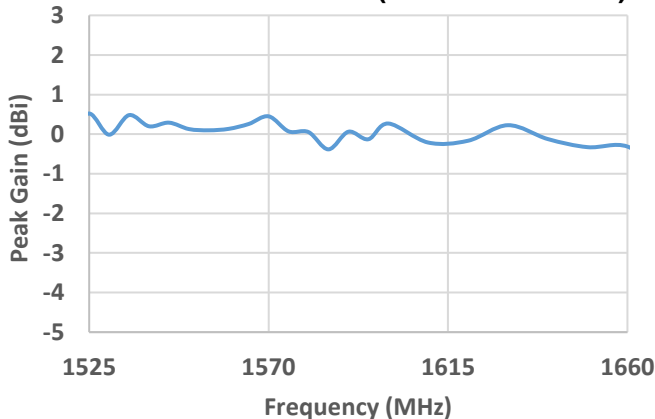

**Peak Gain S-Band (1980 – 2200 MHz)**

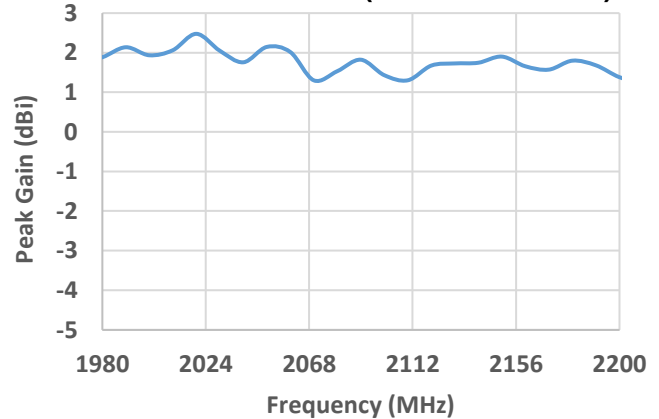



1004795 / 1004796 Embedded 5G / LTE / NTN / GNSS KYOCERA AVX SMT Antenna Specifications.  
KYOCERA AVX produces a wide variety of standard and custom antennas to meet user needs.

### Appendix 2: Antenna Radiation Patterns

Typical 1004795/1004796 performance 60 x 45 mm PCB

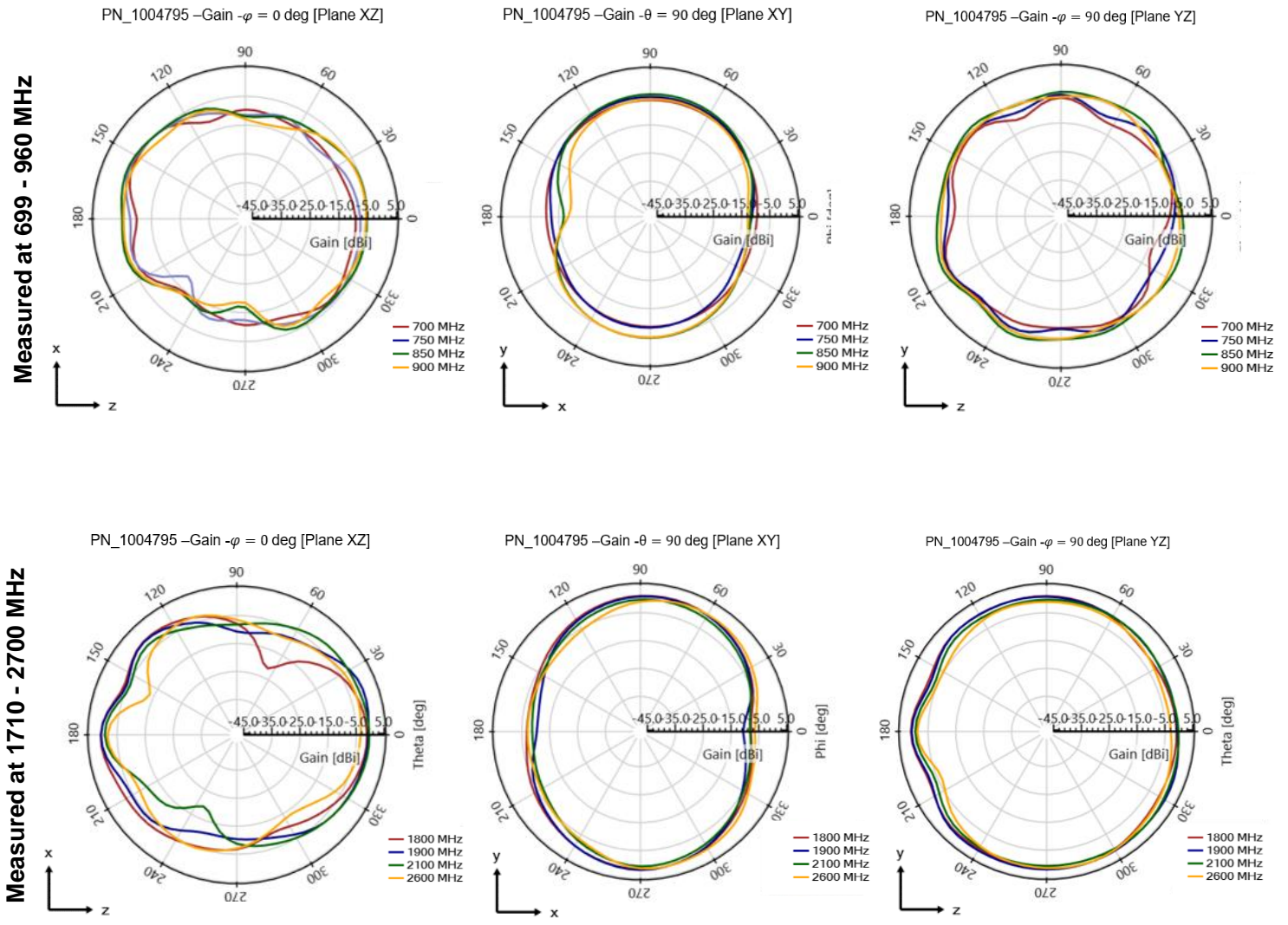
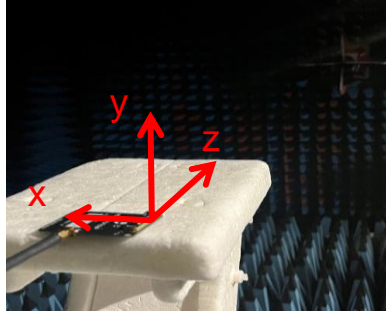

1004795 / 1004796 Embedded 5G / LTE / NTN / GNSS KYOCERA AVX SMT Antenna Specifications.  
KYOCERA AVX produces a wide variety of standard and custom antennas to meet user needs.

### Appendix 2: Antenna Radiation Patterns

Typical 1004795/1004796 performance 60 x 45 mm PCB

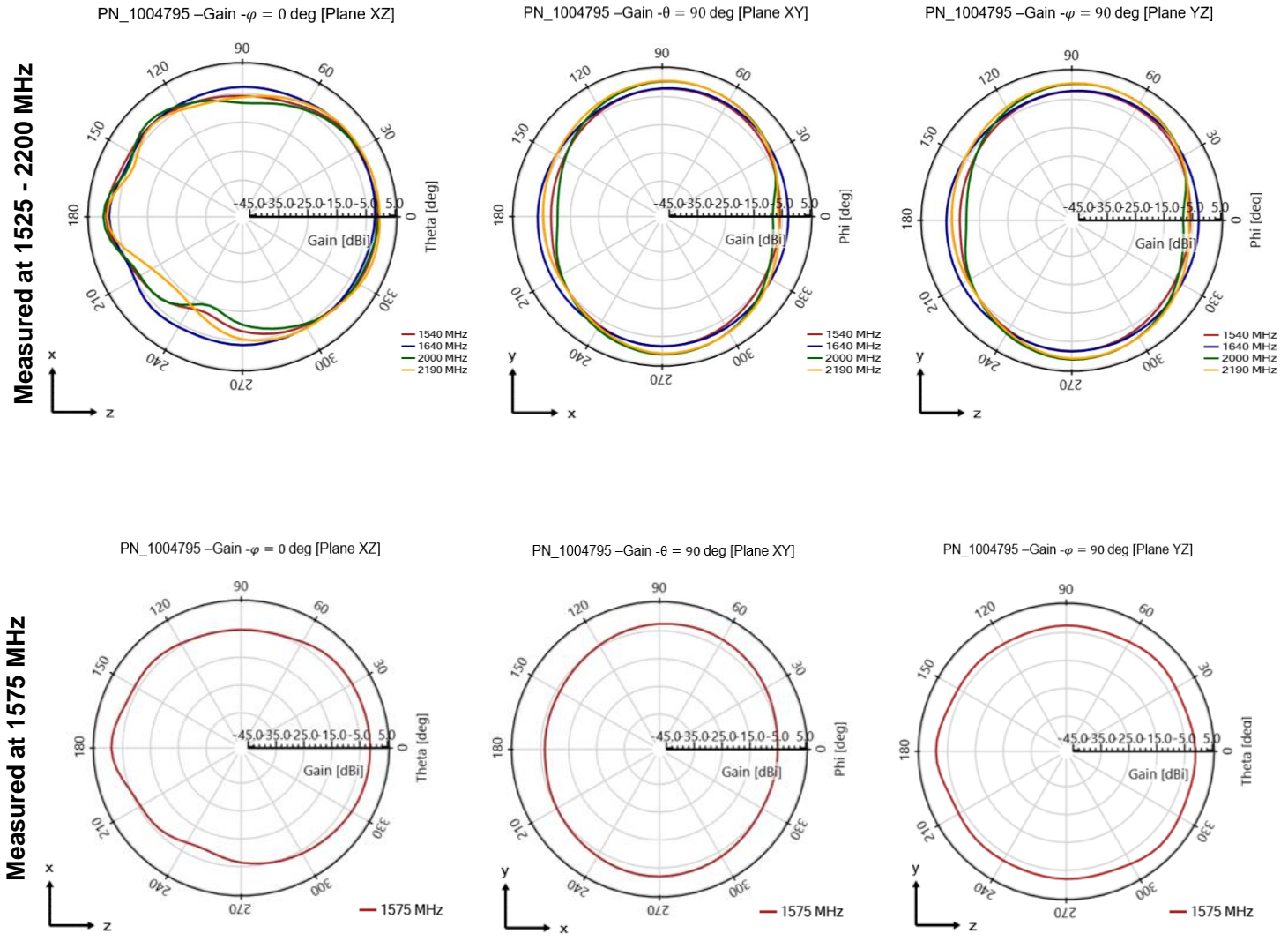
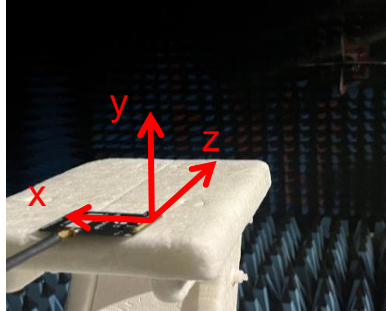

1004795 / 1004796 Embedded 5G / LTE / NTN / GNSS KYOCERA AVX SMT Antenna Specifications.  
 KYOCERA AVX produces a wide variety of standard and custom antennas to meet user needs.

### Recommended Reflow Soldering Profile

The recommended method for soldering the antenna to the board is forced convection reflow soldering. The following suggestions provide information on how to optimize the reflow process for the FR4 antenna:

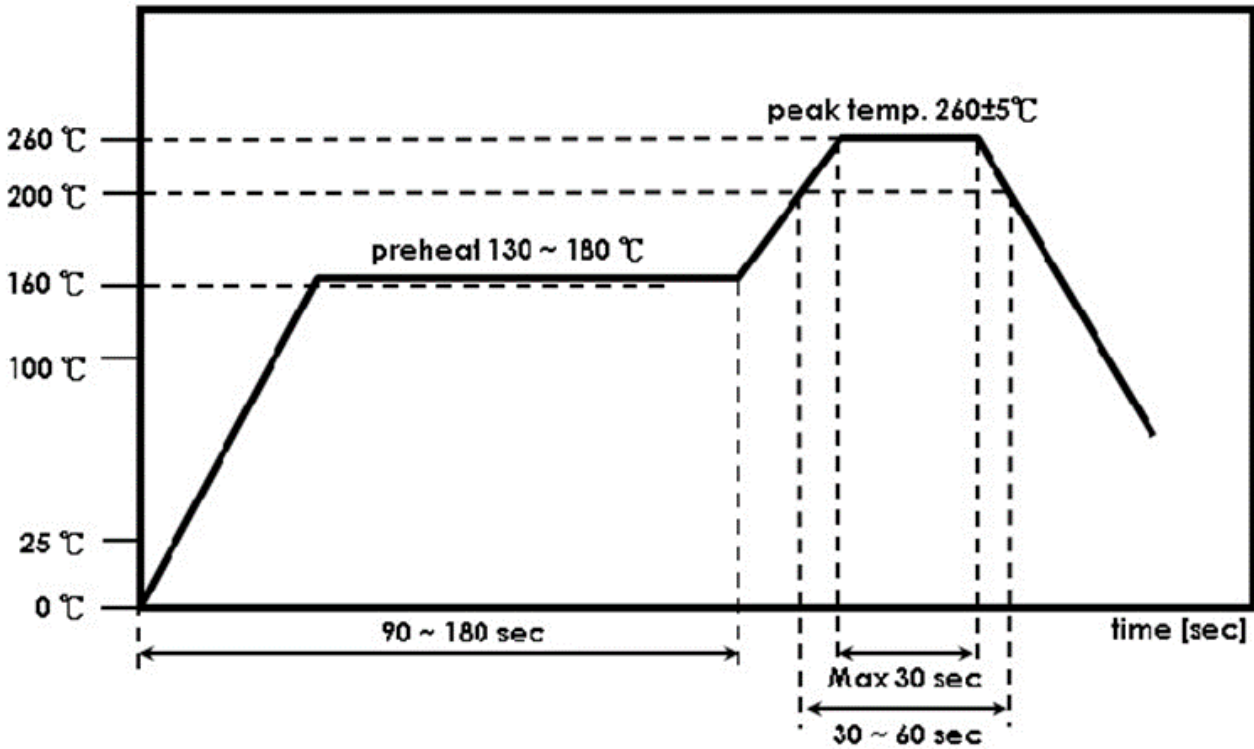

\*Adjust the reflow duration to create good solder joints without raising the antenna temperature beyond the allowed maximum of 260° C.

1004795 / 1004796 Embedded 5G / LTE / NTN / GNSS KYOCERA AVX SMT Antenna Specifications.  
KYOCERA AVX produces a wide variety of standard and custom antennas to meet user needs.

### Additional Resources - 1004795

**Simulation Files:**

HFSS: [https://www.kyocera-avx.com/download/antennas/ansys-hfss/23r1/1004795\\_05052023\\_23R1.zip](https://www.kyocera-avx.com/download/antennas/ansys-hfss/23r1/1004795_05052023_23R1.zip)

**Application Note:**

[https://www.kyocera-avx.com/docs/techinfo/ApplicationNotes/Antenna-AppNotes/AVX-E\\_AppNote-1004795\\_1004796.pdf](https://www.kyocera-avx.com/docs/techinfo/ApplicationNotes/Antenna-AppNotes/AVX-E_AppNote-1004795_1004796.pdf)

**3D Fit File:**

[https://www.kyocera-avx.com/download/antennas/ME-FIT/1004795\\_ME\\_fit.zip](https://www.kyocera-avx.com/download/antennas/ME-FIT/1004795_ME_fit.zip)

**DXF File:**

[https://www.kyocera-avx.com/download/antennas/3D-DXF/1004795\\_3D-DXF.zip](https://www.kyocera-avx.com/download/antennas/3D-DXF/1004795_3D-DXF.zip)

**Gerber File:**

[https://www.kyocera-avx.com/download/antennas/GERBER/1004795\\_GERBERS.zip](https://www.kyocera-avx.com/download/antennas/GERBER/1004795_GERBERS.zip)

### Additional Resources - 1004796

**Simulation Files:**

HFSS: [https://www.kyocera-avx.com/download/antennas/ansys-hfss/23r1/1004796\\_08232022\\_23r1.zip](https://www.kyocera-avx.com/download/antennas/ansys-hfss/23r1/1004796_08232022_23r1.zip)

**Application Note:**

[https://www.kyocera-avx.com/docs/techinfo/ApplicationNotes/Antenna-AppNotes/AVX-E\\_AppNote-1004795\\_1004796.pdf](https://www.kyocera-avx.com/docs/techinfo/ApplicationNotes/Antenna-AppNotes/AVX-E_AppNote-1004795_1004796.pdf)

**3D Fit File:**

[https://www.kyocera-avx.com/download/antennas/ME-FIT/1004796\\_ME\\_fit.zip](https://www.kyocera-avx.com/download/antennas/ME-FIT/1004796_ME_fit.zip)

**DXF File:**

[https://www.kyocera-avx.com/download/antennas/3D-DXF/1004796\\_3D-DXF.zip](https://www.kyocera-avx.com/download/antennas/3D-DXF/1004796_3D-DXF.zip)

**Gerber File:**

[https://www.kyocera-avx.com/download/antennas/GERBER/1004796\\_GERBERS.zip](https://www.kyocera-avx.com/download/antennas/GERBER/1004796_GERBERS.zip)

### Reference Designs



**KYOCERA AVX Band Switching Solution 1004795-EC646-01** in 45.5x60mm<sup>2</sup> PCB:  
<https://datasheets.kyocera-avx.com/1004795-EC646-01.pdf>



**Nordic Semiconductor nRF9160** in a 53x53 mm<sup>2</sup> PCB:  
<https://datasheets.kyocera-avx.com/nordic-nRF9160-ref-design.pdf>



**u-blox SARA-R5** in a 70x45 mm<sup>2</sup> PCB:  
[https://content.u-blox.com/sites/default/files/documents/B37-AntennaTuning-Blueprint\\_AppNote\\_UBX-22012527.pdf](https://content.u-blox.com/sites/default/files/documents/B37-AntennaTuning-Blueprint_AppNote_UBX-22012527.pdf)