

XC61C Series



Standard Voltage Detectors ($V_{DF}=1.6V\sim 6.0V$)

◆CMOS

- ◆Highly Accurate : $\pm 2\%$
- ◆Low Power Consumption : $0.7\mu A$ ($V_{IN} = 1.5V$)
- ◆Ultra small SSOT-24 (SC-82) Package

■General Description

The XC61C series are highly precise, low power consumption voltage detectors, manufactured using CMOS and laser trimming technologies. Detect voltage is extremely accurate with minimal temperature drift.

Both CMOS and N-channel open drain output configurations are available.

■Applications

- Microprocessor reset circuitry
- Memory battery back-up circuits
- Power-on reset circuits
- Power failure detection
- System battery life and charge voltage monitors

■Features

- Highly accurate** : $\pm 2\%$
- Low power consumption** : TYP $0.7\mu A$ [$V_{IN}=1.5V$]
- Detect voltage range** : $1.6V \sim 6.0V$ in $0.1V$ increments
- Operating voltage range** : $0.7V \sim 10.0V$
- Detect voltage temperature characteristics** : $TYP \pm 100ppm/^{\circ}C$
- Output configuration** : N-channel open drain or CMOS
- Ultra small package** : SSOT-24 (150mW) super mini-mold
: SOT-23 (150mW) mini-mold
: SOT-89 (500mW) mini-power mold
: TO-92 (300mW)

■Typical Application Circuits

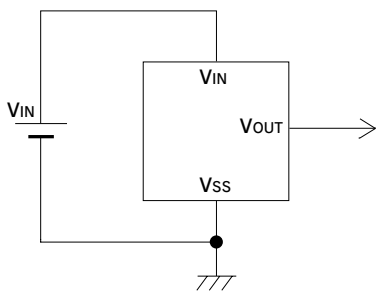

CMOS Output

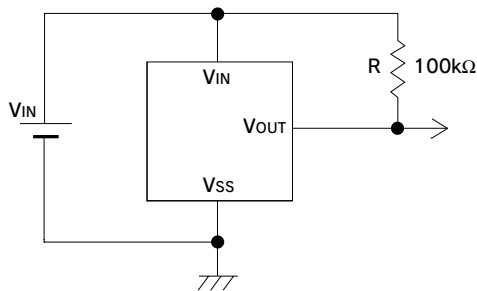

N-ch Open Drain Output

■Typical Performance Characteristic

SUPPLY CURRENT vs. INPUT VOLTAGE

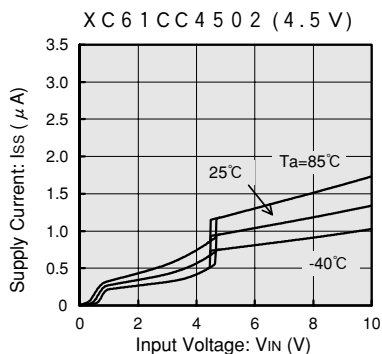

Pin Configuration

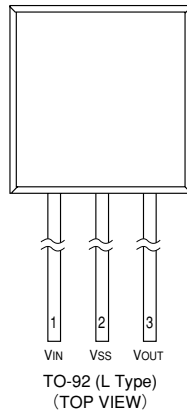
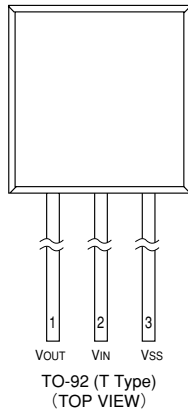
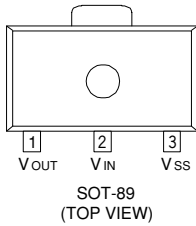
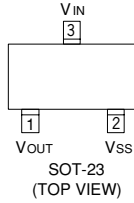
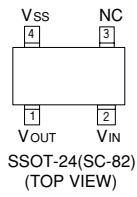

Pin Assignment

| PIN NUMBER | | | | | PIN NAME | FUNCTION |
|------------|--------|--------|-----------|-----------|----------|----------------------|
| SSOT-24 | SOT-23 | SOT-89 | TO-92 (T) | TO-92 (L) | | |
| 2 | 3 | 2 | 2 | 1 | VIN | Supply Voltage Input |
| 4 | 2 | 3 | 3 | 2 | VSS | Ground |
| 1 | 1 | 1 | 1 | 3 | VOUT | Output |
| 3 | - | - | - | - | NC | No Connection |

2

Product Classification

Ordering Information

XC61C xx xx xx xx
a b c d e f

| DESIGNATOR | DESCRIPTION | DESIGNATOR | DESCRIPTION |
|------------|---|------------|--|
| a | Output Configuration : C = CMOS N = N-ch open drain | e | Package Type: N = SSOT-24 (SC-82) M = SOT-23 P = SOT-89 T = TO-92 (Standard) L = TO-92 (Custom Pin Configuration) |
| b | Detect Voltage : 25 = 2.5V 38 = 3.8V | f | Device Orientation : R = Embossed Tape (Right) L = Embossed Tape (Left) H = Paper Type (TO-92) B = Bag (TO-92) |
| c | Output Delay : 0 = No delay | | |
| d | Detect Accuracy : 2 = within $\pm 2.0\%$ | | |

■ Packaging Information

● SSOT-24 (SC-82)

2

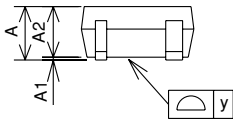
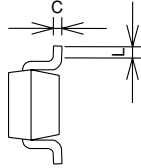
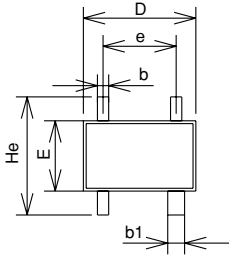

| | SIZE mm | | |
|----|---------|-------|-------|
| | MIN | TYP | MAX |
| A | 0.80 | — | 1.10 |
| A1 | 0.00 | — | 0.10 |
| A2 | 0.80 | — | 1.00 |
| b | 0.15 | 0.25 | 0.30 |
| b1 | 0.25 | 0.35 | 0.40 |
| C | 0.075 | 0.125 | 0.225 |
| D | 1.80 | 2.00 | 2.20 |
| E | 1.15 | 1.25 | 1.45 |
| He | 1.80 | 2.10 | 2.40 |
| e | 1.10 | 1.30 | 1.50 |
| L | 0.10 | 0.30 | — |
| y | — | — | 0.10 |

● SOT-23

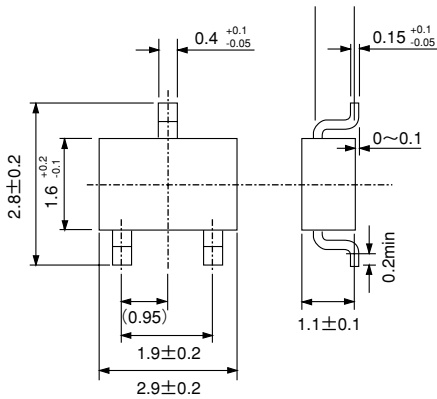

●SOT-89

2

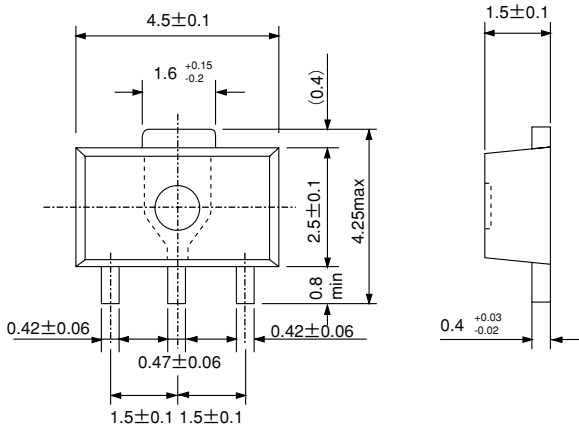

●TO-92

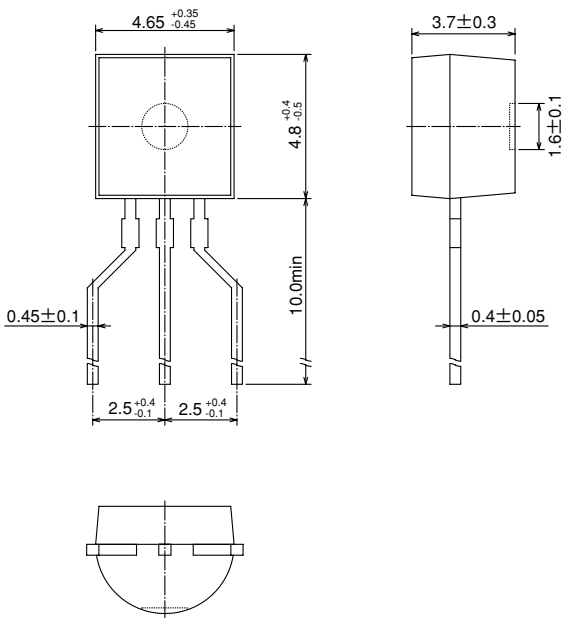

■ Marking

● SSOT-24, SOT-23, SOT-89

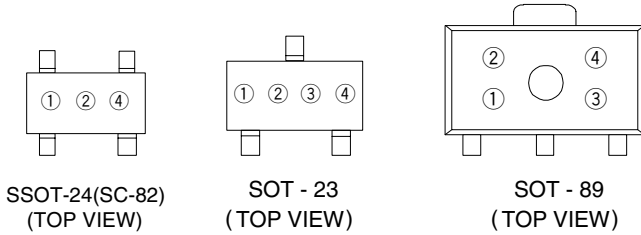

① Represents the integer of the Output Voltage and Detect Voltage

| DESIGNATOR | CONFIGURATION | VOLTAGE (V) |
|------------|---------------|-------------|
| A | CMOS | 0.② |
| B | CMOS | 1.② |
| C | CMOS | 2.② |
| D | CMOS | 3.② |
| E | CMOS | 4.② |
| F | CMOS | 5.② |
| H | CMOS | 6.② |

| DESIGNATOR | CONFIGURATION | VOLTAGE (V) |
|------------|---------------|-------------|
| K | N-ch | 0.② |
| L | N-ch | 1.② |
| M | N-ch | 2.② |
| N | N-ch | 3.② |
| P | N-ch | 4.② |
| R | N-ch | 5.② |
| S | N-ch | 6.② |

② Represents the decimal number of the Detect Voltage

| DESIGNATOR | VOLTAGE | DESIGNATOR | VOLTAGE |
|------------|---------|------------|---------|
| 0 | ①.0 | 5 | ①.5 |
| 1 | ①.1 | 6 | ①.6 |
| 2 | ①.2 | 7 | ①.7 |
| 3 | ①.3 | 8 | ①.8 |
| 4 | ①.4 | 9 | ①.9 |

③ Based on Internal Standards
(SSOT-24 excepted)

| DESIGNATOR |
|------------|
| 3 |

④ Represents the assembly lot no.
Based on internal standards

● TO-92

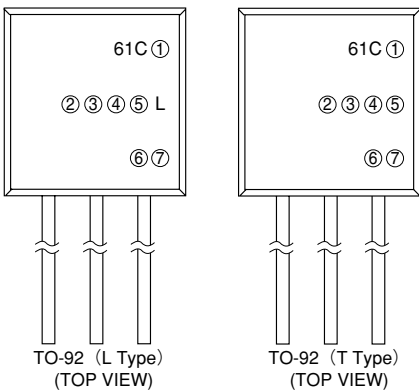

① Represents the output configuration

| DESIGNATOR | OUTPUT CONFIGURATION |
|------------|----------------------|
| C | CMOS |
| N | N-ch |

② Represents the Detect Voltage

| DESIGNATOR | | VOLTAGE (V) |
|------------|---|-------------|
| ② | ③ | |
| 3 | 3 | 3.3 |
| 5 | 0 | 5.0 |

④ Indicates Delay Time

| DESIGNATOR | DELAY TIME |
|------------|------------|
| 0 | No delay |

⑤ Represents the Detect Voltage Accuracy

| DESIGNATOR | DETECT VOLTAGE ACCURACY |
|------------|--------------------------------|
| 1 | within $\pm 1\%$ (semi-custom) |
| 2 | within $\pm 2\%$ |

⑥ Represents a least significant digit of the produced year

| DESIGNATOR | Produced year |
|------------|---------------|
| 0 | 2000 |
| 1 | 2001 |

⑦ Denotes the production lot number
0 to 9, A to Z repeated(G.I.J.O.Q.W excepted)

Block Diagram

(1) CMOS Output

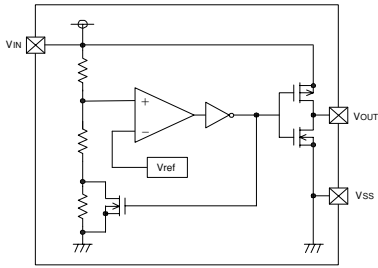

(2) N-ch Open Drain Output

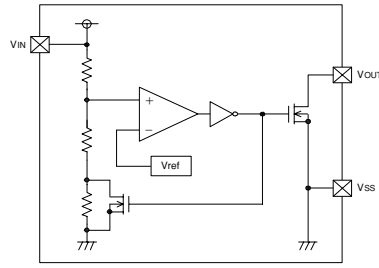

2

Absolute Maximum Ratings

Ta = 25°C

| PARAMETER | SYMBOL | RATINGS | UNITS |
|-------------------------------|------------------|---|-------|
| Input Voltage | V _{IN} | 12 | V |
| Output Current | I _{OUT} | 50 | mA |
| Output Voltage | CMOS | V _{SS} - 0.3 ~ V _{IN} + 0.3 | V |
| | N-ch open drain | V _{SS} - 0.3 ~ 12 | |
| Power Dissipation | P _d | SSOT-24 | 150 |
| | | SOT-23 | 150 |
| | | SOT-89 | 500 |
| | | TO-92 | 300 |
| Operating Ambient Temperature | T _{opr} | -40 ~ +85 | °C |
| Storage Temperature | T _{stg} | -40 ~ +125 | °C |

Electrical Characteristics

VDF (T) = 1.6 to 6.0V ± 2%

Ta = 25°C

| PARAMETER | SYMBOL | CONDITIONS | MIN | TYP | MAX | UNITS | CIRCUIT |
|--------------------------------------|---|--|---------------|---------------|---------------|--------|---------|
| Detect Voltage | VDF | | VDF x 0.98 | VDF | VDF x 1.02 | V | 1 |
| Hysteresis Range | VHYS | | VDF x 0.02 | VDF x 0.05 | VDF x 0.08 | V | 1 |
| Supply Current | ISS | VIN = 1.5V | | 0.7 | 2.3 | μA | 2 |
| | | =2.0V | | 0.8 | 2.7 | | |
| | | =3.0V | | 0.9 | 3.0 | | |
| | | =4.0V | | 1.0 | 3.2 | | |
| | | =5.0V | | 1.1 | 3.6 | | |
| Operating Voltage | VIN | VDF(T) = 1.6V to 6.0V | 0.7 | | 10.0 | V | 1 |
| Output Current | IOUT | N-ch VDS=0.5V VIN=1.0V | =2.0V | 1.0 | 2.2 | mA | 3 |
| | | | =3.0V | 3.0 | 7.7 | | |
| | | | =4.0V | 5.0 | 10.1 | | |
| | | | =5.0V | 6.0 | 11.5 | | |
| | | | =5.0V | 7.0 | 13.0 | | |
| | | P-ch VDS=2.1V VIN=8.0V (with CMOS output) | | -10.0 | -2.0 | | |
| Temperature Characteristics | $\frac{\Delta VDF}{\Delta T_{opr} \cdot VDF}$ | -40°C ≤ Topr ≤ 85°C | | ± 100 | | ppm/°C | - |
| Delay Time (VDR → VOUT inversion) | tDLY | | | | 0.2 | ms | 5 |

Note :

VDF (T) : Established Detect Voltage Value

Release Voltage : VDR = VDF + VHYS

2

Functional Description

Functional Description (CMOS output)

- ① When input voltage (V_{IN}) rises above detect voltage (V_{DF}), output voltage (V_{OUT}) will be equal to V_{IN} .
(A condition of high impedance exists with N-ch open drain output configurations.)
- ② When input voltage (V_{IN}) falls below detect voltage (V_{DF}), output voltage (V_{OUT}) will be equal to the ground voltage (V_{SS}) level.
- ③ When input voltage (V_{IN}) falls to a level below that of the minimum operating voltage (V_{MIN}), output will become unstable. In this condition, V_{IN} will equal the pulled-up output (should output be pulled-up.)
- ④ When input voltage (V_{IN}) rises above the ground voltage (V_{SS}) level, output will be unstable at levels below the minimum operating voltage (V_{MIN}). Between the V_{MIN} and detect release voltage (V_{DR}) levels, the ground voltage (V_{SS}) level will be maintained.
- ⑤ When input voltage (V_{IN}) rises above detect release voltage (V_{DR}), output voltage (V_{OUT}) will be equal to V_{IN} .
(A condition of high impedance exists with N-ch open drain output configurations.)
- ⑥ The difference between V_{DR} and V_{DF} represents the hysteresis range.

Timing Chart

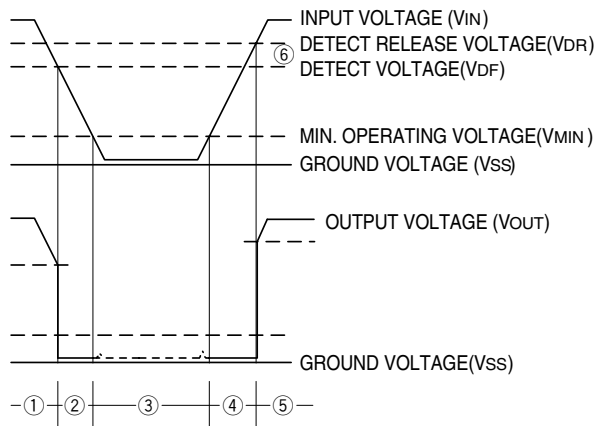

■ Directions for use

● Notes on Use

1. Please use this IC within the stated maximum ratings. Operation beyond these limits may cause degrading or permanent damage to the device.
2. When a resistor is connected between the VIN pin and the input with CMOS output configurations, oscillation may occur as a result of voltage drops at RIN if load current (IOUT) exists. (refer to the Oscillation Description (1) below)
3. When a resistor is connected between the VIN pin and the input with CMOS output configurations, irrespective of N-ch output configurations, oscillation may occur as a result of through current at the time of voltage release even if load current (IOUT) does not exist. (refer to the Oscillation Description (2) below)
4. With a resistor connected between the VIN pin and the input, detect and release voltage will rise as a result of the IC's supply current flowing through the VIN pin.
5. In order to stabilise the IC's operations, please ensure that VIN pin's input frequency's rise and fall times are more than several μ sec / V.
6. Please use N-ch open drains configuration, when a resistor RIN is connected between the VIN pin and power source. In such cases, please ensure that RIN is less than 10k Ω and that C is more than 0.1 μ F.

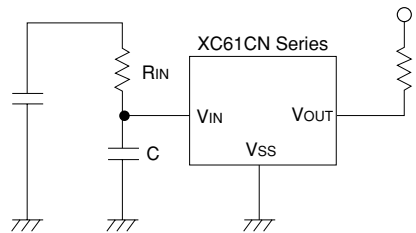

Diagram: Circuit using an input resistor

● Oscillation Description

(1) Output current oscillation with the CMOS output configuration

When the voltage applied at IN rises, release operations commence and the detector's output voltage increases. Load current (IOUT) will flow at RL. Because a voltage drop ($R_{IN} \times I_{OUT}$) is produced at the RIN resistor, located between the input (IN) and the VIN pin, the load current will flow via the IC's VIN pin. The voltage drop will also lead to a fall in the voltage level at the VIN pin. When the VIN pin voltage level falls below the detect voltage level, detect operations will commence. Following detect operations, load current flow will cease and since voltage drop at RIN will disappear, the voltage level at the VIN pin will rise and release operations will begin over again. Oscillation may occur with this " release - detect - release " repetition.

Further, this condition will also appear via means of a similar mechanism during detect operations.

(2) Oscillation as a result of through current

Since the XC61C series are CMOS ICs, through current will flow when the IC's internal circuit switching operates (during release and detect operations). Consequently, oscillation is liable to occur as a result of drops in voltage at the through current's resistor (RIN) during release voltage operations. (refer to diagram 2)

Since hysteresis exists during detect operations, oscillation is unlikely to occur.

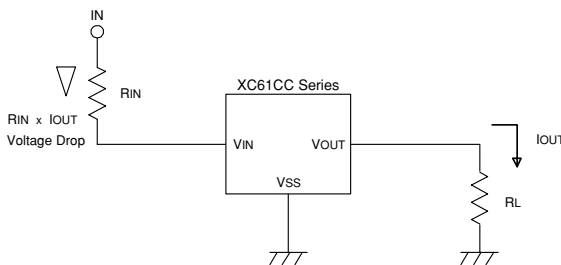

Diagram 1: Oscillation in relation to output current

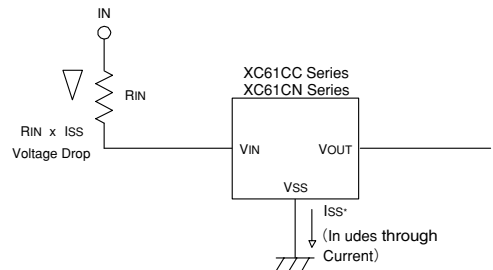
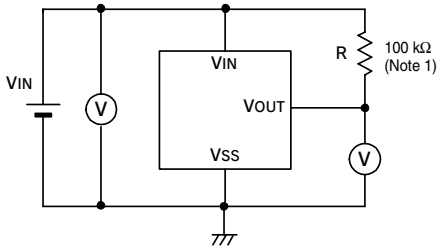

Diagram 2: Oscillation in relation to through current

Measuring Circuits

Circuit 1



Circuit 2

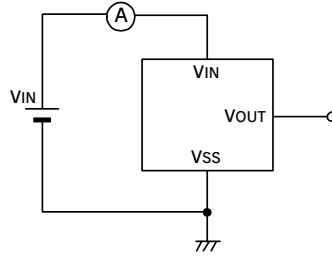

Circuit 3

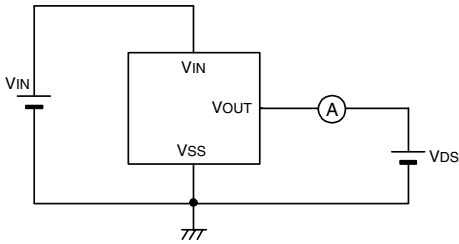

Circuit 4

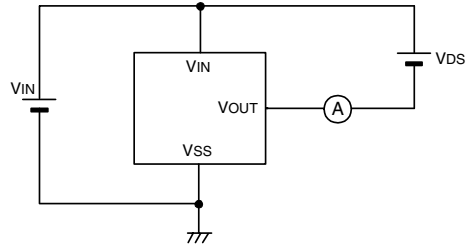

Circuit 5

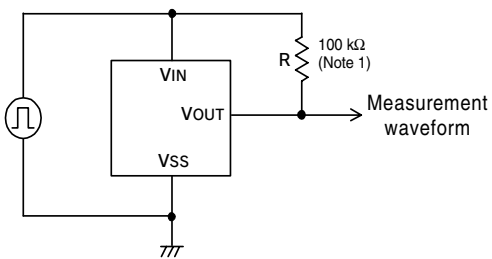

Note 1 : Not necessary with CMOS output products.

Typical Performance Characteristics

(1) SUPPLY CURRENT vs. INPUT VOLTAGE

XC61CC1802 (1.8 V)

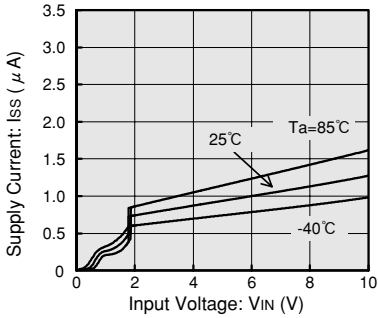

XC61CC2702 (2.7 V)

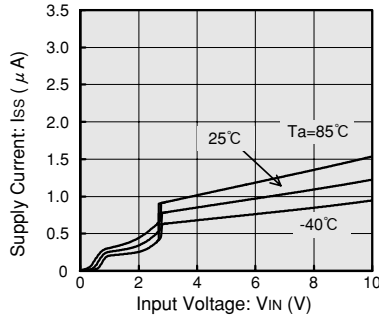

XC61CC3602 (3.6 V)

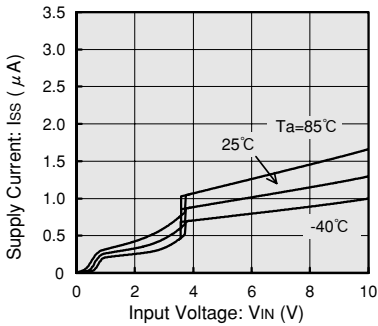

XC61CC4502 (4.5 V)

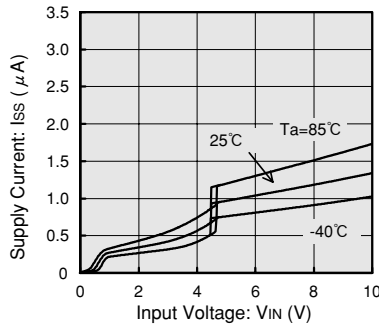

(2) DETECT, RELEASE VOLTAGE vs. AMBIENT TEMPERATURE

XC61CC1802 (1.8 V)

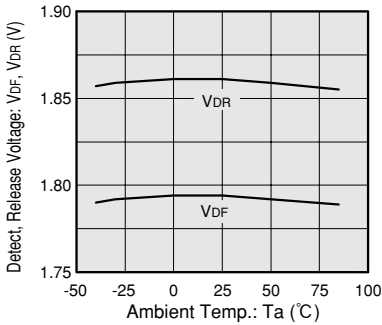

XC61CC2702 (2.7 V)

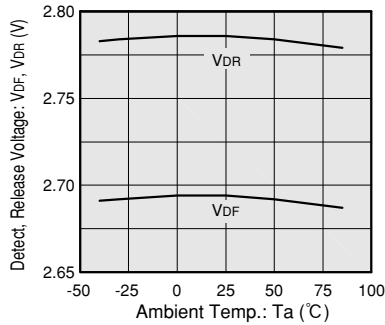

XC61CC3602 (3.6 V)

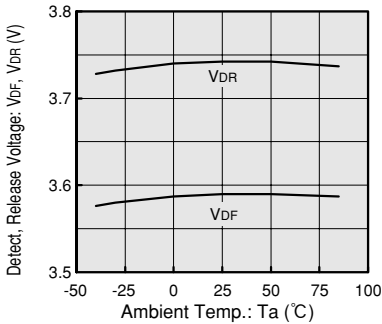

XC61CC4502 (4.5 V)

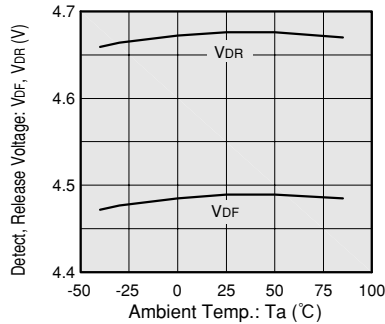

2

(3) OUTPUT VOLTAGE vs. INPUT VOLTAGE

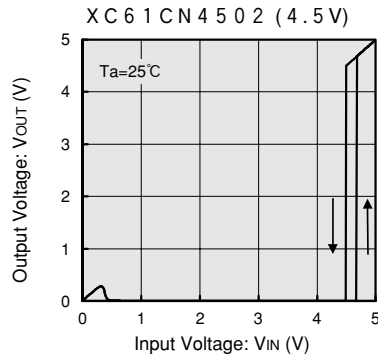
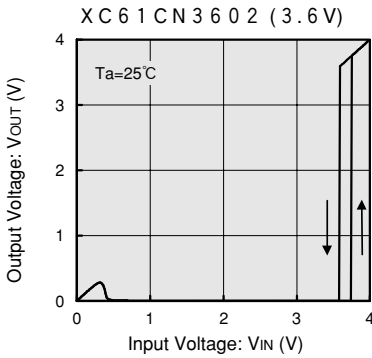
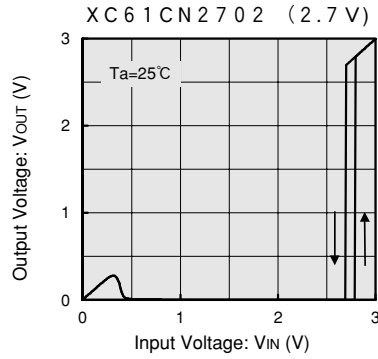
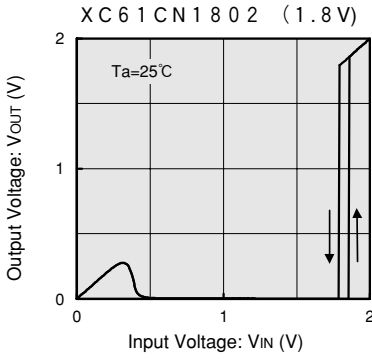

Note : The N-channel open drain pull up resistance value is 100k Ω .

(4) N-ch DRIVER OUTPUT CURRENT vs. V_{DS}

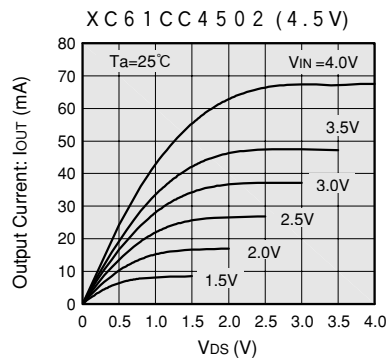
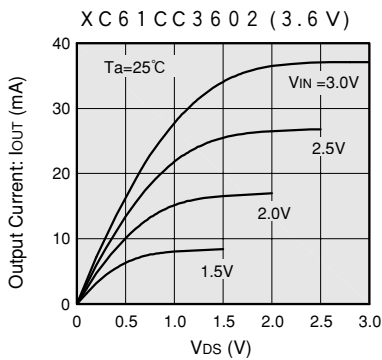
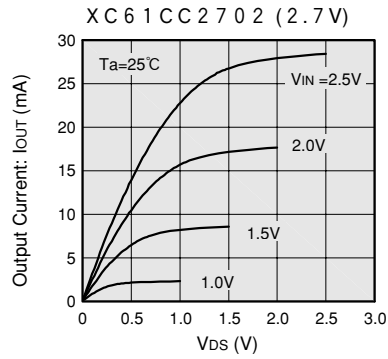
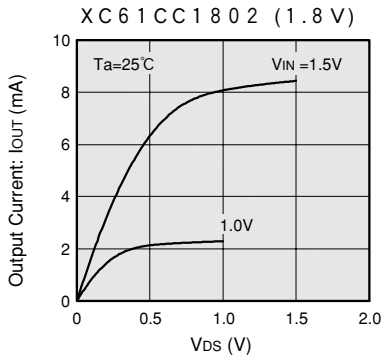

(4) N-ch DRIVER OUTPUT CURRENT vs. V_{DS}

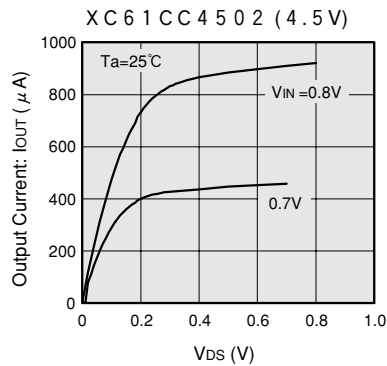
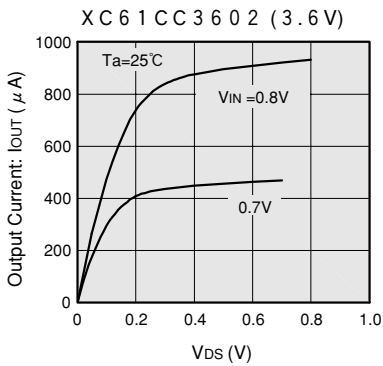
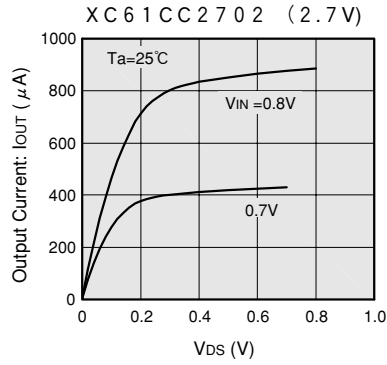
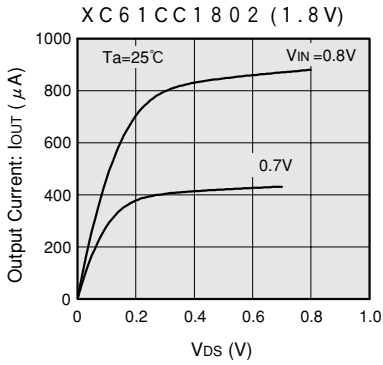

(5) N-ch DRIVER OUTPUT CURRENT vs. INPUT VOLTAGE

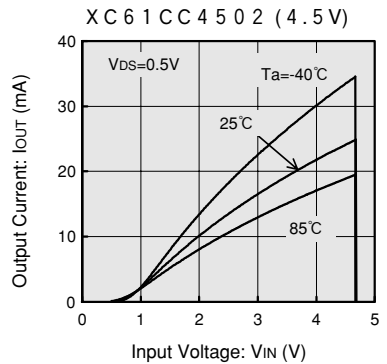
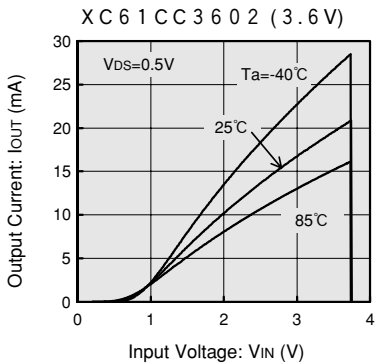
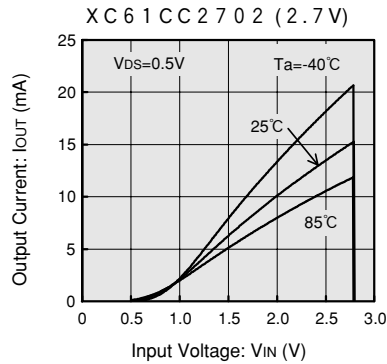
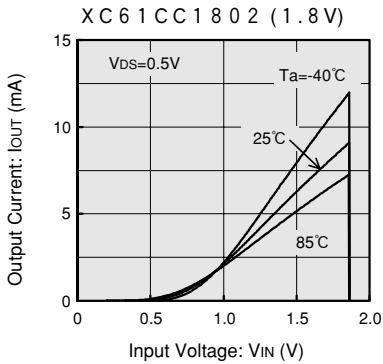

(6) P-ch DRIVER OUTPUT CURRENT vs. INPUT VOLTAGE

XC61CC1802 (1.8V)

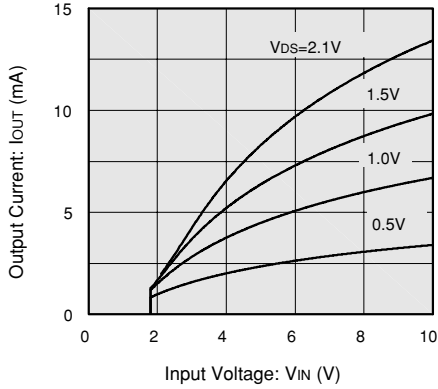

XC61CC2702 (2.7V)

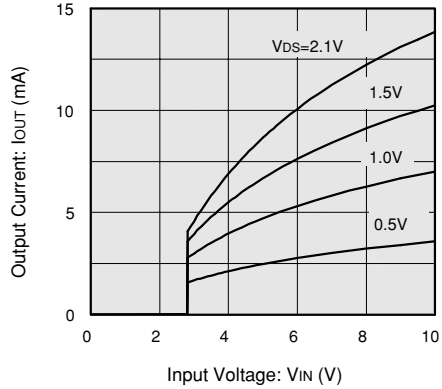

XC61CC3602 (3.6V)

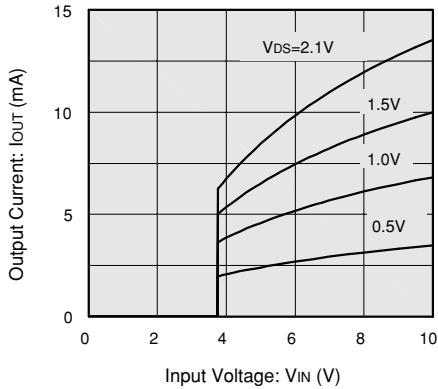

XC61CC4502 (4.5V)

