



ESDA17/19-5SC6

ASD™

TRANSIL™ ARRAY FOR ESD PROTECTION

MAIN APPLICATIONS

Where transient overvoltage protection in ESD sensitive equipment is required, such as:

- Computers
- Printers and other peripherals
- Communications systems
- Cellular phone handsets and accessories
- Other telephone sets
- Consumer Electronics (Set top boxes, DVD players, TV sets)

FEATURES

- 5 unidirectional Transil functions
- Minimum breakdown voltage range:
 $V_{BR \text{ min.}} = 17V$ or $19V$
- Peak pulse power (8/20 μ s); 150W
- Tiny leakage current at stand-off voltage:
< 100nA

DESCRIPTION

The ESDA17/19-5SC6 is a monolithic array designed to protect up to 5 lines against ESD transients.

The device is ideal for applications where board space saving is required.

BENEFITS

- High ESD protection level
- High integration
- Suitable for high density boards

COMPLIES WITH THE FOLLOWING STANDARDS:

- IEC61000-4-2 level 4:
 - 15kV (air discharge)
 - 8kV (contact discharge)
- MIL STD 883E-Method 3015-7: class3
 - 25kV (Human Body Model)

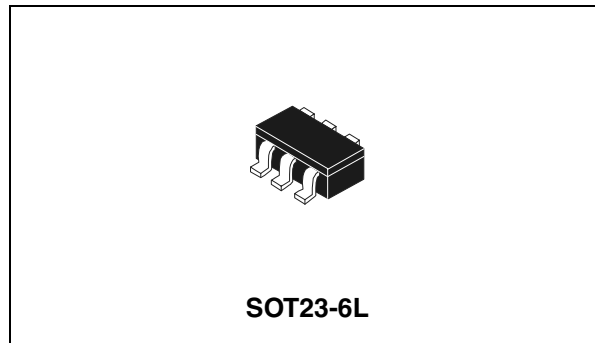
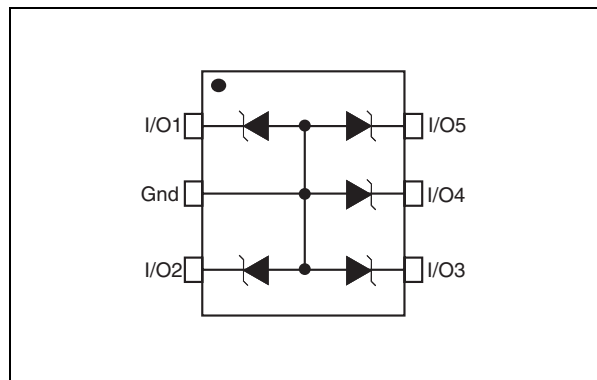

Table 1: Order Codes

Part Number	Marking
ESDA17-5SC6	175
ESDA19-5SC6	195

Figure 1: Functional Diagram



TM: ASD is a trademark of STMicroelectronics.

Table 2: Absolute Maximum Ratings ($T_{amb} = 25^{\circ}C$)

Symbol	Parameter		Value	Unit
V_{PP}	ESD discharge	IEC61000-4-2 air discharge IEC61000-4-2 contact discharge	± 15 ± 8	kV
P_{PP}	Peak pulse power (8/20 μ s) (note 1)	T_j initial = T_{amb}	150	W
T_j	Junction temperature		125	$^{\circ}C$
T_{stg}	Storage temperature range		-55 to +150	$^{\circ}C$
T_L	Maximum lead temperature for soldering during 10 s at 5mm for case		260	$^{\circ}C$
T_{op}	Operating temperature range		-40 to +125	$^{\circ}C$

Note 1: For a surge greater than the maximum values, the diode will fail in short-circuit.

Table 3: Electrical Characteristics ($T_{amb} = 25^{\circ}C$)

Symbol	Parameter
V_{RM}	Stand-off voltage
V_{BR}	Breakdown voltage
V_{CL}	Clamping voltage
I_{RM}	Leakage current
I_{PP}	Peak pulse current
αT	Voltage temperature coefficient
V_F	Forward voltage drop
C	Capacitance
R_d	Dynamic resistance

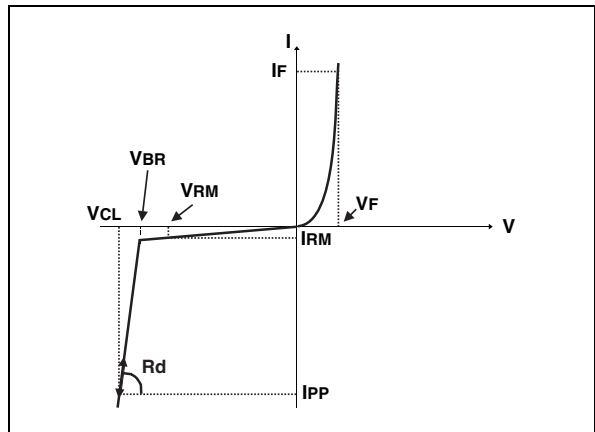

Types	V_{BR} @		I_R	I_{RM} @ V_{RM}		R_d	αT	C	V_F @ I_F	
	min.	max.		max.					max.	
	V	V	mA	nA	V	Ω	$10^{-4}/^{\circ}C$	pF	V	mA
ESDA17-5SC6	17	19	1	75	14	1	10	33	1.2	10
ESDA19-5SC6	19	21	1	100	15	1	8.5	33	1.2	10

Note 2: Square pulse, $I_{PP} = 15A$, $t_p = 2.5\mu s$.

Note 3: $\Delta V_{BR} = \alpha T * (T_{amb} - 25^{\circ}C) * V_{BR}(25^{\circ}C)$.

Figure 2: Relative variation of peak pulse power versus initial junction temperature

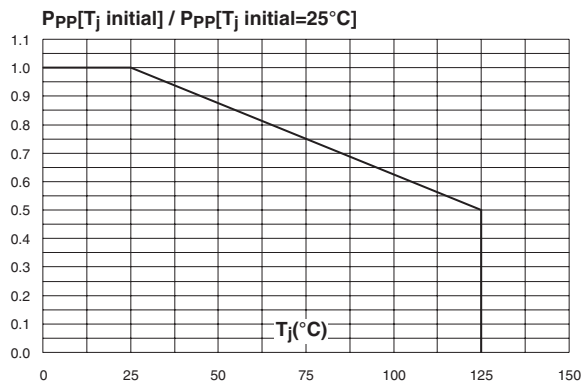

Figure 3: Peak pulse power versus exponential pulse duration

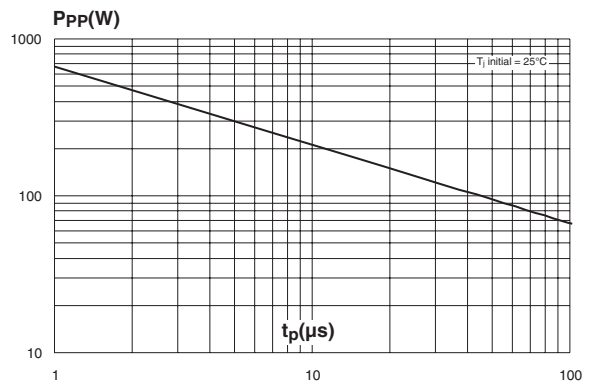

Figure 4: Clamping voltage versus peak pulse current (typical values, rectangular waveform)

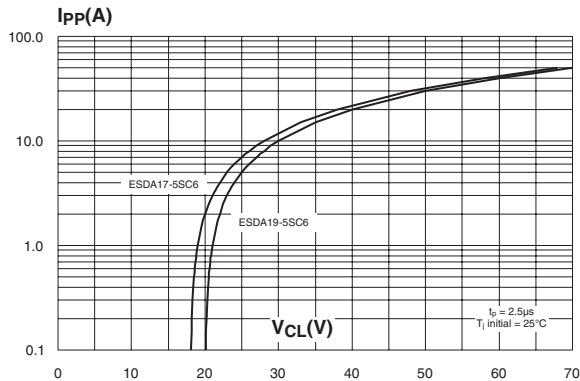

Figure 5: Forward voltage drop versus peak forward current (typical values)

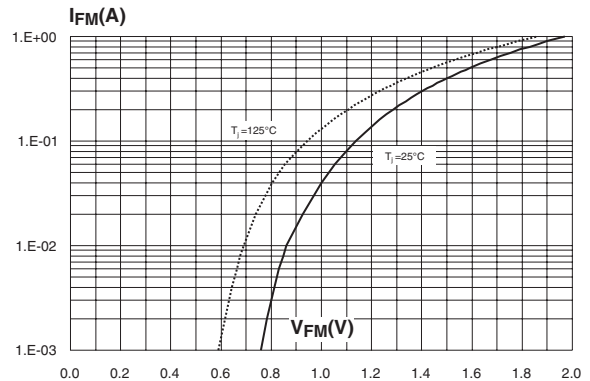

Figure 6: Junction capacitance versus reverse voltage applied (typical values)

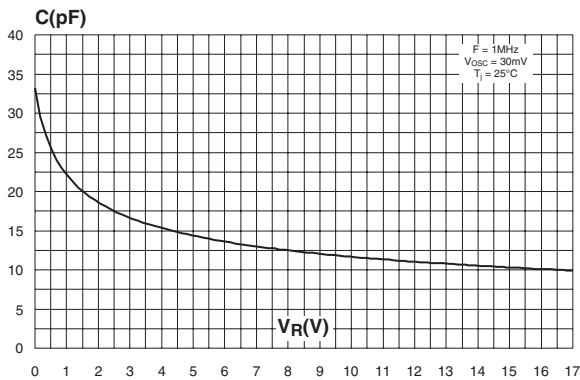

Figure 7: Relative variation of leakage current versus junction temperature (typical values)

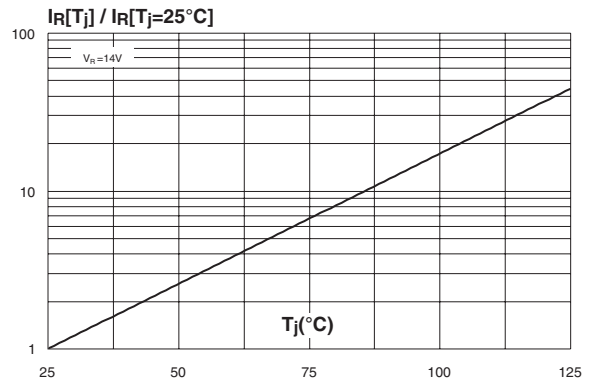

Figure 8: Ordering information scheme

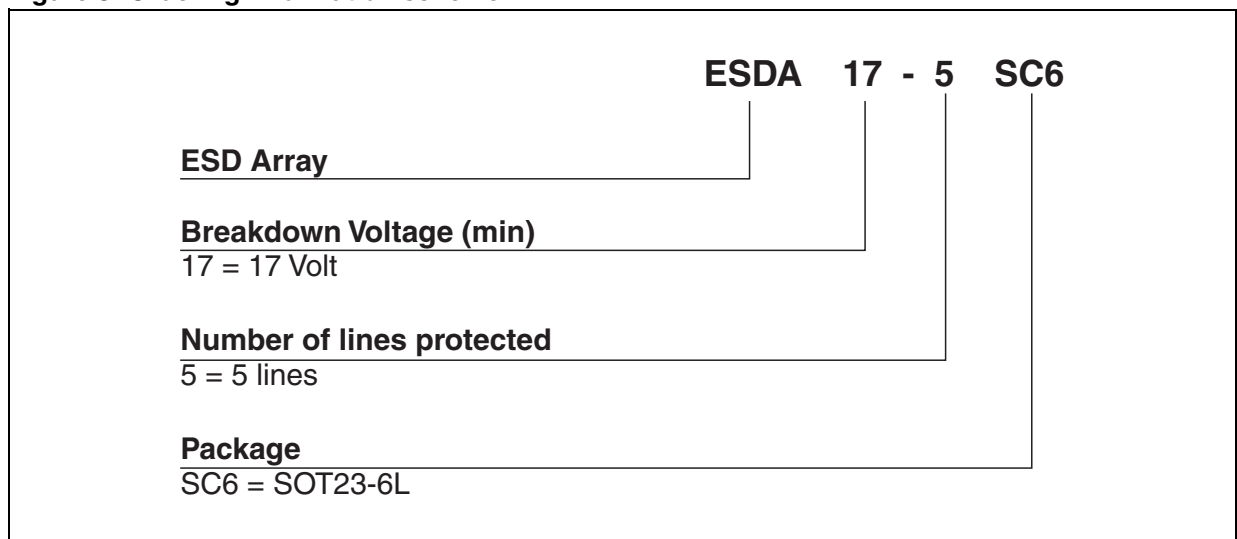

Figure 9: SOT23-6L Package Mechanical Data

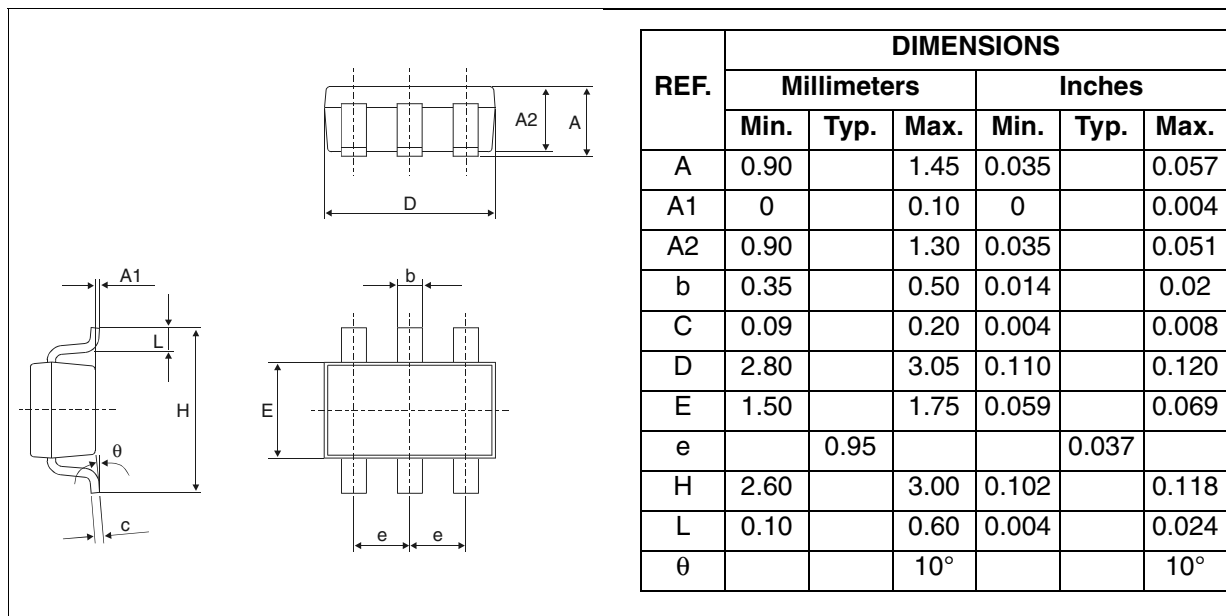

Figure 10: Foot Print Dimensions (in millimeters)

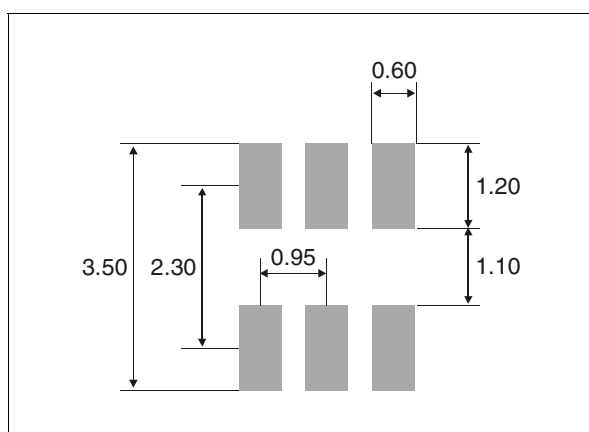

Table 4: Ordering Information

Part Number	Marking	Package	Weight	Base qty	Delivery mode
ESDA17-5SC6	175	SOT23-6L	16.7 mg	3000	Tape & reel
ESDA19-5SC6	195				

Table 5: Revision History

Date	Revision	Description of Changes
Nov-2002	1A	First issue.
4-Nov-2004	2	SOT23-6L package dimensions change for reference "D" from 3.0 millimeters (0.118 inches) to 3.05 millimeters (0.120 inches).

Information furnished is believed to be accurate and reliable. However, STMicroelectronics assumes no responsibility for the consequences of use of such information nor for any infringement of patents or other rights of third parties which may result from its use. No license is granted by implication or otherwise under any patent or patent rights of STMicroelectronics. Specifications mentioned in this publication are subject to change without notice. This publication supersedes and replaces all information previously supplied. STMicroelectronics products are not authorized for use as critical components in life support devices or systems without express written approval of STMicroelectronics.

The ST logo is a registered trademark of STMicroelectronics.
All other names are the property of their respective owners

© 2004 STMicroelectronics - All rights reserved

STMicroelectronics group of companies

Australia - Belgium - Brazil - Canada - China - Czech Republic - Finland - France - Germany - Hong Kong - India - Israel - Italy - Japan -
Malaysia - Malta - Morocco - Singapore - Spain - Sweden - Switzerland - United Kingdom - United States of America
www.st.com

