

OUTLINE

1. OUTLINE "PC-CON"

"PC-CON" has lowest E.S.R. level and excellent performance high frequency though low profile.

"PC-CON" is an ideal capacitor for digital and high frequency devices. Furthermore, it has high heat resistance and high reliability.

2. FEATURES

- ◆ Low impedance and low E.S.R. at high frequency.

- ◆ High ripple current capability.

- ◆ Excellent temperature characteristics from -55°C

- ◆ Reflow soldering method available (250°C , 5 sec)

- ◆ Excellent endurance characteristics

3. APPLICATIONS

- ◆ **Application circuit**
Noise-Limiter, Smoothing circuit of power supply.

- ◆ **Applied equipment**
Personal Computers, LCD-TV, Car Navigation, HDD (Hard Disc Drive), PDA (Personal Digital Assistants) etc.



◆ PRODUCT LIST

SL / SLE SERIES

() : E.S.R. mΩ

Cap (μF) \ WV (V.DC)	2V		2.5V		4V		6.3V	
	10							
47								SLE(9)
68						SLE(9)		
82				SLE(9)				
100		SLE(9)						

SXB / SXE SERIES

() : E.S.R. mΩ

Cap (μF) \ WV (V.DC)	2V		2.5V		4V		6.3V		8V	
	15									
47									SXB(13) SXE(9)	
56									SXE(9)	
68						SXB(13) SXE(9)			SXE(9)	
82				SXB(13) SXE(9)		SXE(9)			SXE(9)	
100		SXB(13) SXE(9)		SXE(9)		SXE(9)			SXE(9)	
120		SXE(9)		SXE(9)		SXE(9)				
150		SXE(9)		SXE(9)		SXE(9)				
180		SXE(9)		SXE(9)						
220		SXE(9)								

SW SERIES

() : E.S.R. mΩ

Cap (μF) \ WV (V.DC)	2V		2.5V		4V		6.3V		8V		
	2.7mm	2.9mm	2.7mm	2.9mm	2.7mm	2.9mm	2.7mm	2.9mm	2.7mm		
33											SW(13)
100									SW(10)		
120										SW(7)	
150						SW(10)				SW(7)	
180				SW(10)					SW(7)		
220		SW(10)				SW(7)			SW(7)		
270				SW(7)					SW(7)		
330				SW(7)							
390				SW(7)							

◆ SERIES CHART
SL Series

Low profile (Within 1.5mm height)

SXB Series

Standard

SW Series

High capacitance, Ultra low E.S.R.

SLE Series

Low profile, Low E.S.R.

SXE Series

Low E.S.R.

◆ SPECIFICATIONS

- RoHS compliance
- Pb Free and compatible with reflow soldering (250°C, 5sec)

Series	SL	SLE	SXB	SXE	SW	
Category Temperature Range (°C)	- 55 ~ + 105°C					
Rated Voltage Range (V. DC)	6.3	2~6.3	2~8	2~6.3	2~8	2~6.3
Rated Cap. Range (μF)	10	47~100	33~100	47~220	100~220	330~390
Capacitance Tolerance (20°C/120Hz)	±20%					
Leakage Current (after 2 minutes) (μA)	≤0.04CV					
Dissipation Factor (20°C/120Hz)	≤0.05				≤	≤0.1
Equivalent Series Resistance (E.S.R.) (mΩ) (20°C/100kHz)	≤50	≤9	≤13 ≤15 (8V)	≤9	≤10 ≤13 (8V)	≤7
Maximum Permissible Ripple Current (mA r.m.s)(100kHz)	1900	3000	3000		3500	
Surge Voltage	Rated voltage × 1.3					
Endurance (+105°C, 2000hrs, Rated voltage applied) (20°C)	ΔC/C	Within ±20% of the initial value				
	tan δ	≤150%	≤200% of initial specified value			≤150%
	LC	≤initial specified value				
Damp heat (Steady state) (+60°C, 90 to 95%RH, 500hrs, No-applied voltage) (20°C)	ΔC/C	Within -20 ~ + 40% of the initial value				
	tan δ	≤150%	≤200% of initial specified value			≤150%
	LC	≤500%	≤300% of initial specified value			

◆ MARKING

※1 2 and 3 columns are indicative significant figures. 1 column show the number of the zero following significant figures by pF. (multipliers of ten)
 ※2 Lot No. shows roughly manufacturing date, Jan to Sep. are 1 to 9, Oct. is O, Nov. is N, and Dec. is D.
 ※3 Rated voltage mark

Mark	Rated voltage
d	2 V.DC
e	2.5 V.DC
g	4 V.DC
j	6.3 V.DC
k	8 V.DC

◆ PART NUMBER

Code	Rated Voltage
2	2 V.DC
2R5	2.5 V.DC
4	4 V.DC
6	6.3 V.DC
8	8 V.DC

Code	Series
SL	SL series
SLE	SLE series
SXB	SXB series
SXE	SXE series
SW	SW series

Code	Capacitance
10	10
15	15
33	33
47	47
56	56
68	68
82	82
100	100
120	120
150	150
180	180
220	220
270	270
330	330
390	390

Code	Tolerance
M	± 20%

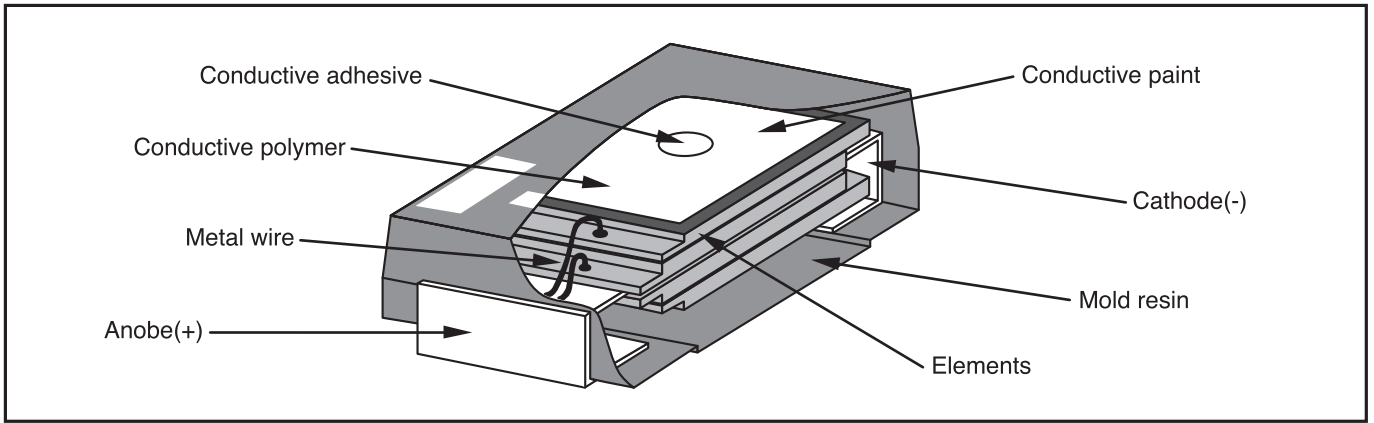
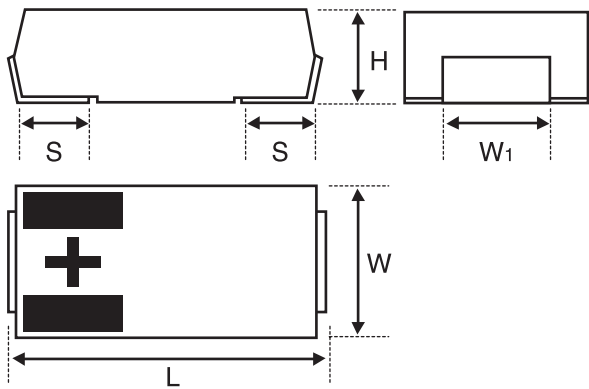
◆ STRUCTURE

◆ DIMENSIONS

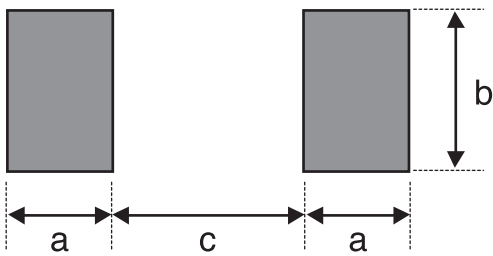
Series	L (±0.2)	W (±0.2)	H (±0.2)	S (±0.2)	W1 (±0.2)
SL/SLE	7.3	4.3	1.4	1.3	2.4
SXB/SXE	7.3	4.3	1.9	1.3	2.4
SW	7.3	4.3	2.7	1.3	2.4
SW(7mΩ)	7.3	4.3	2.9	1.3	2.4

◆ RECOMMENDED LAND PATTERN DIMENSIONS

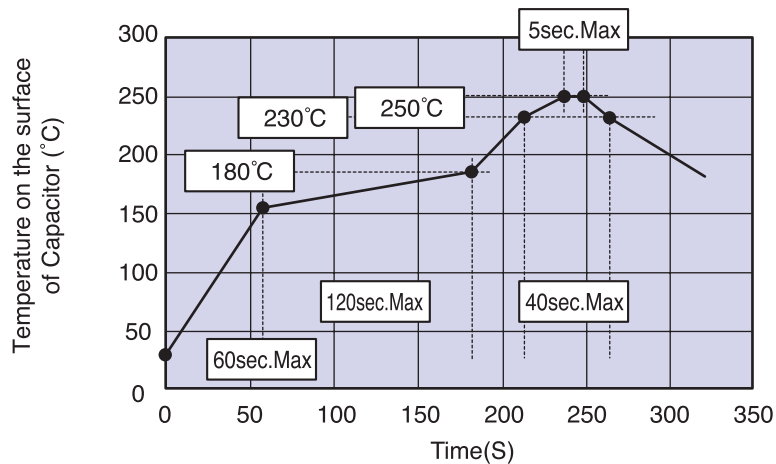
Series	a	b	c
SL/SLE	2.4	2.9	3.7
SXB/SXE			
SW			
SW(7mΩ)			

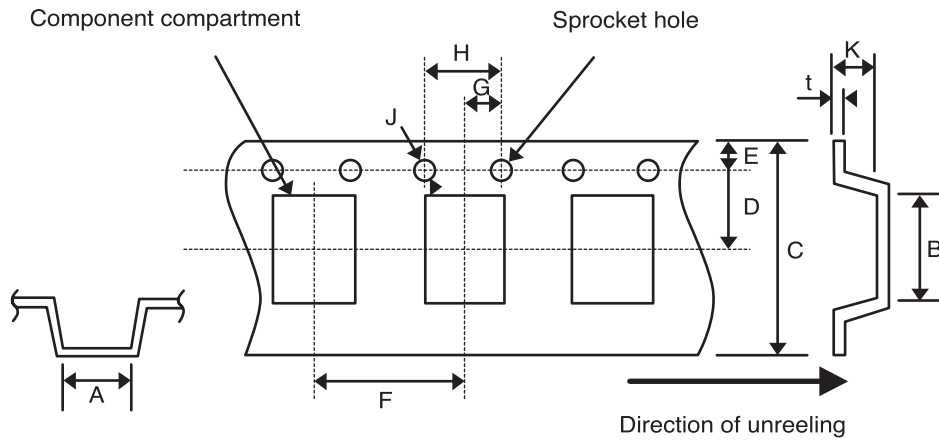
◆ RECOMMENDED REFLOW SOLDERING CONDITION

◆ CARRIER TAPE DIMENSIONS

(mm)

	A ±0.1	B ±0.1	C ±0.3	D ±0.05	E ±0.1	F ±0.1	G ±0.05	H ±0.1	J -0,+0.1	K ±0.1	t ±0.05
SL/SLE	4.55	7.65	12.0	5.5	1.75	8.0	2.0	4.0	ø1.5	1.6	0.3
SXB/SXE										2.1	
SW										2.9	
SW(>330 μ F)										3.1	

- ◆ Dimension A and B are the measure of compartment's inside bottom.
- ◆ The polarity of the chip is placed on right side towards the unreeling direction.
- ◆ Dimension of top cover tape (Thickness of cover tape : $75 \pm 25 \mu\text{m}$, Width of cover tape : $9.5 \pm 0.2\text{mm}$)

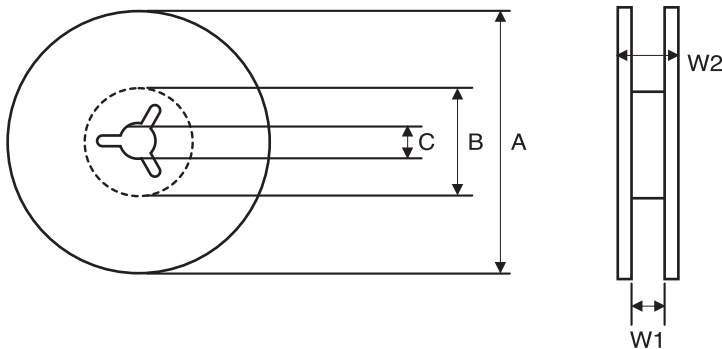
◆ REEL DIMENSIONS

Packing quantity

Series	Pieces/Reel
SL/SLE	3000
SXB/SXE	3000
SW	2000

EIAJ ET-7200

(mm)

A	B	C	W1	W2
$\phi 33 \pm 0.2$	$\phi 80 \pm 1$	$\phi 13 \pm 0.2$	13.5 ± 0.5	17.5 ± 1.0

◆ CHARACTERISTICS

◆ FREQUENCY CHARACTERISTICS

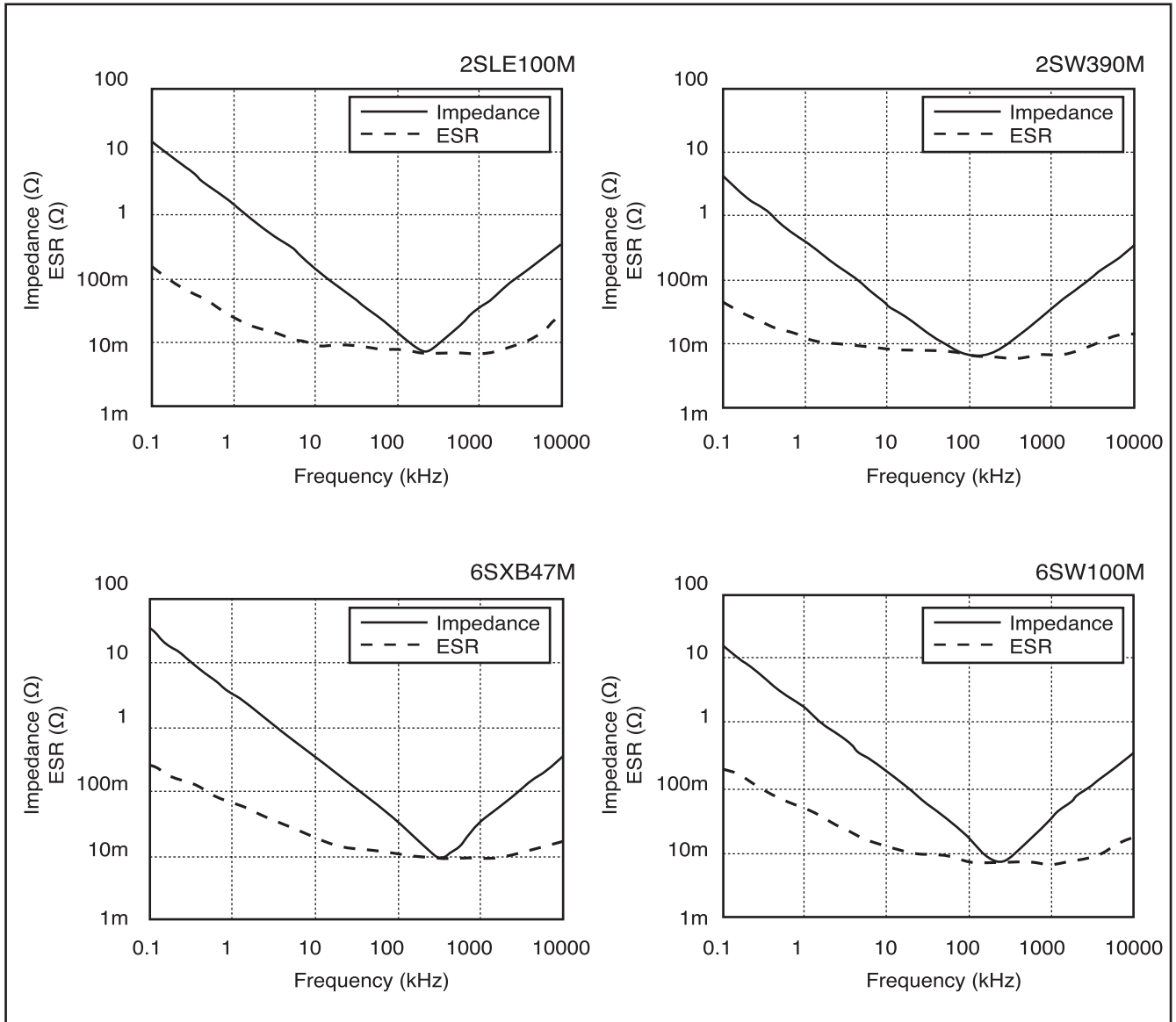

◆ TEMPERATURE CHARACTERISTICS

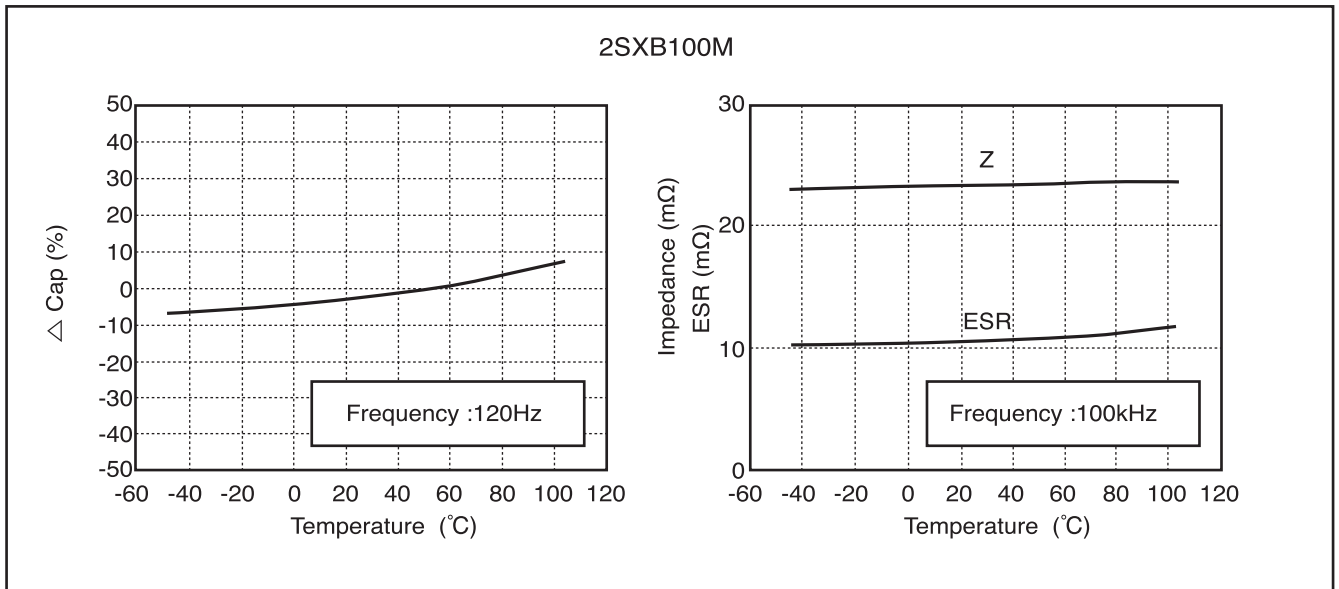

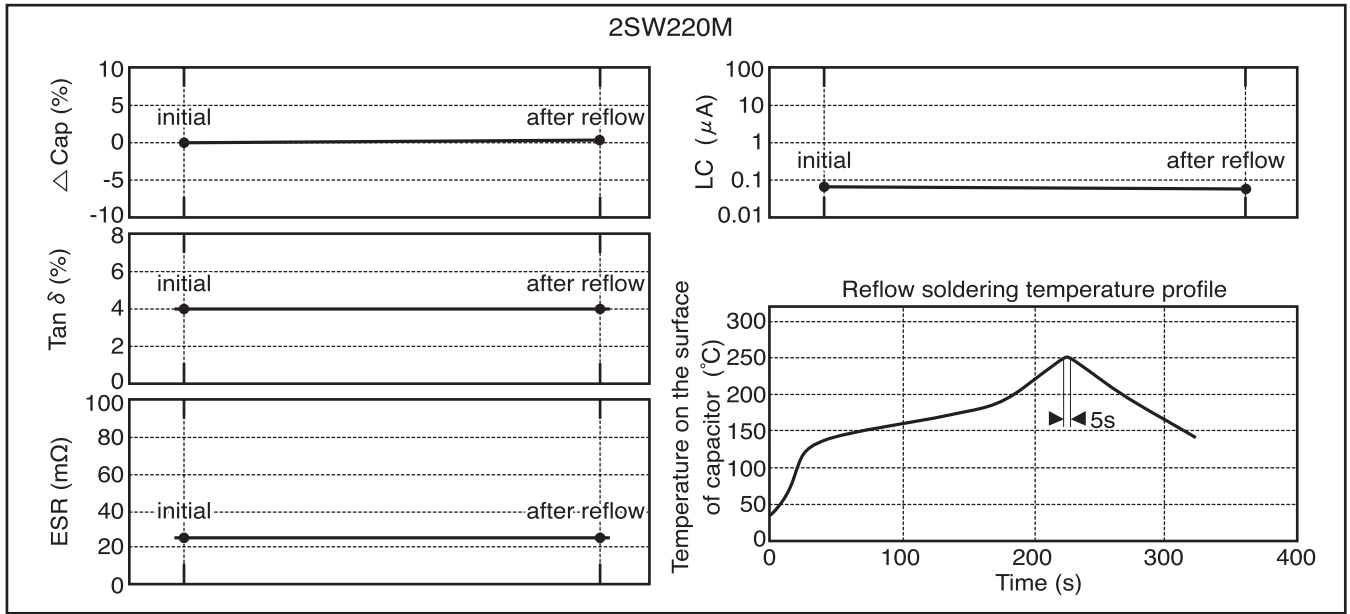
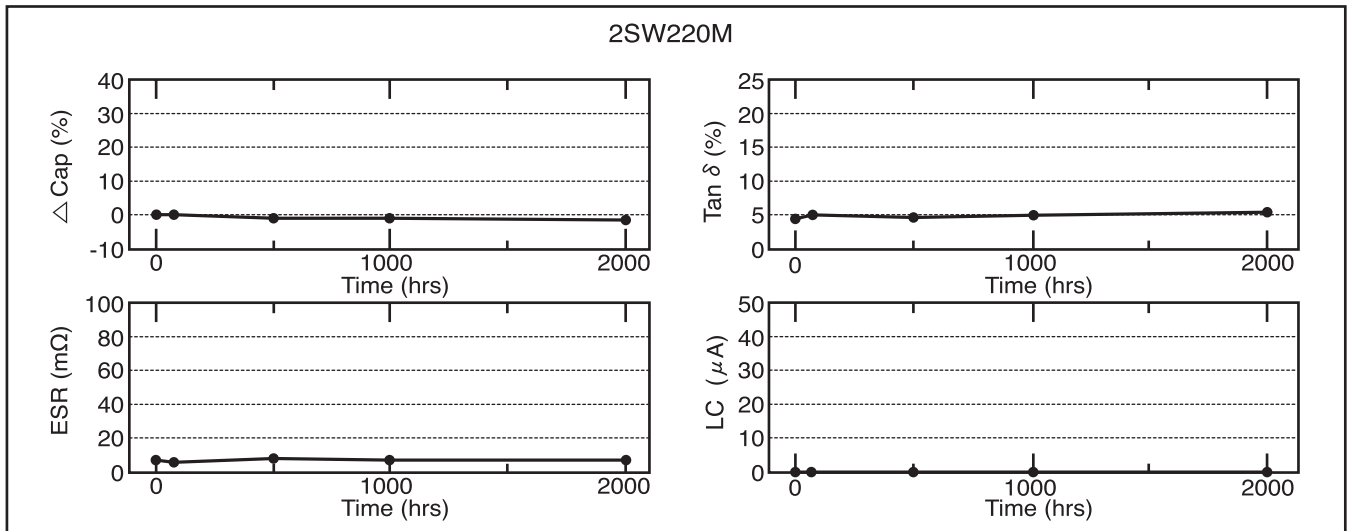
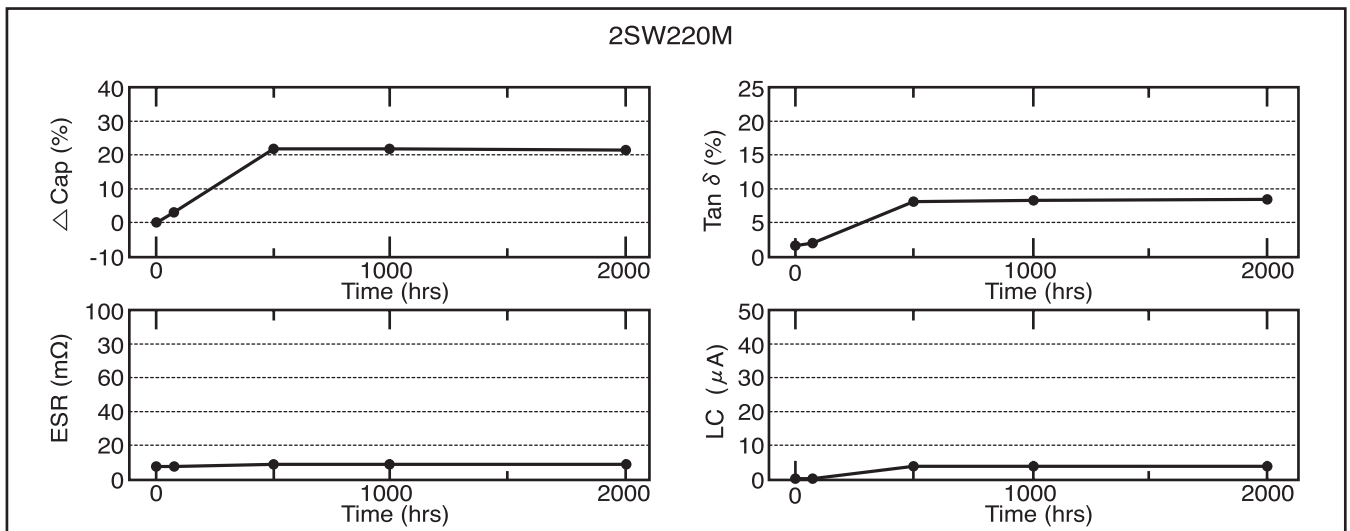
◆ RESISTANCE TO REFLOW SOLDERING HEAT

◆ ENDURANCE (105°C, Rated voltage applied)

◆ DAMP HEAT (STEADY STATE) (60°C, 95%RH, No applied voltage)



CAUTION FOR PROPER USE OF "PC-CON"

Please note that operation installation environments follow the specified condition detailed in specification sheets.

1. PROHIBITED CIRCUITS

Do not use the "PC-CON" in the following circuits.

- (1) Coupling circuits
- (2) Time-constants circuits
- (3) The leakage current greatly affects circuit operations

2. POLARITY

"PC-CON" has polarity, so be sure to verify the marking of capacitor before use.

If it is with polarities reversed increased leakage current or it may cause a short circuit.

3. OPERATING VOLTAGE

Over voltage exceeding the rated voltage should not be applied. It may caused a short circuit.

4. OPERATING TEMPERATURE

Use capacitors within the specified temperature range.

If used outside the specified temperature range, then the electrical characteristics may deteriorate significantly, leading to failure.

The temperature referred to here includes the ambient temperature including heat produced by heat generating devices (power transistors, resistors, etc.), self heating due to ripple current.

5. RIPPLE CURRENT

Observe the allowable ripple current.

When excessive ripple current is applied, it may result in shorter life due to the internal heat increase.

6. SOLDERING

Soldering conditions (temperature, time, etc.) described in the specifications.

If used the conditions exceeding the range of specified, there is a possibility of the intensive increase of leakage current, and the capacitance reduction.

7. LEAKAGE CURRENT

The leakage current become large by heat pressure from soldering and mechanical stress from transportation.

In such a case, leakage current will gradually decrease by applying within the rated voltage at a within category temperature range.

8. OPERATING ENVIRONMENT

Do not use the "PC-CON" in the following environments.

- (1) Places where water, salt water or oil can directly fall on it, and places where condensation may form.
- (2) Places filled with noxious gas (hydrogen sulfide, sulfurous acid, nitrous acid, chlorine, ammonia, etc.).
- (3) Places susceptible to ozone, ultraviolet rays and radiation.

9. FAILURE MODE

The main failure mode of "PC-COM" is open circuit affected by temperature, and the other failure mode is short circuit by an over voltage and/or reverse voltage.

The time until failure occurs can be extended by using "PC-CON" with reduced ambient temperature, ripple current and applied voltage.

10. STORAGE

Store the "PC-COM" in a location that is not subject to direct sunlight and that has temperature less than 5°C to 30°C and a relative humidity less than 70% generally.

It is preferable to store for no more than 1 year under the above condition.

11. DISPOSAL

Dispose of "PC-COM" as industrial waste because they consist of various metals and resin.