

CRIMP TOOL

INSTRUCTION MANUAL

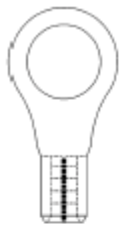

Ring



Multiple-Stud-Ring

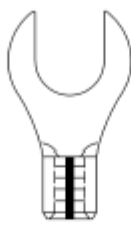

Fork



Spade

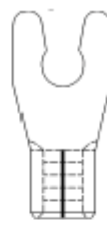

Locking Spade

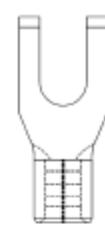

Flange Spade

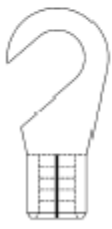

Hook

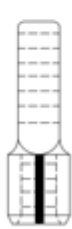

Blade



Pin



Parallel



Butt



Pin

Introduction:

The hand tool is designed to crimp a variety of loose piece insulated terminals/connectors. It combines the general purpose service tools with the reliability and ease of use of crimping premium insulated terminals/connectors.

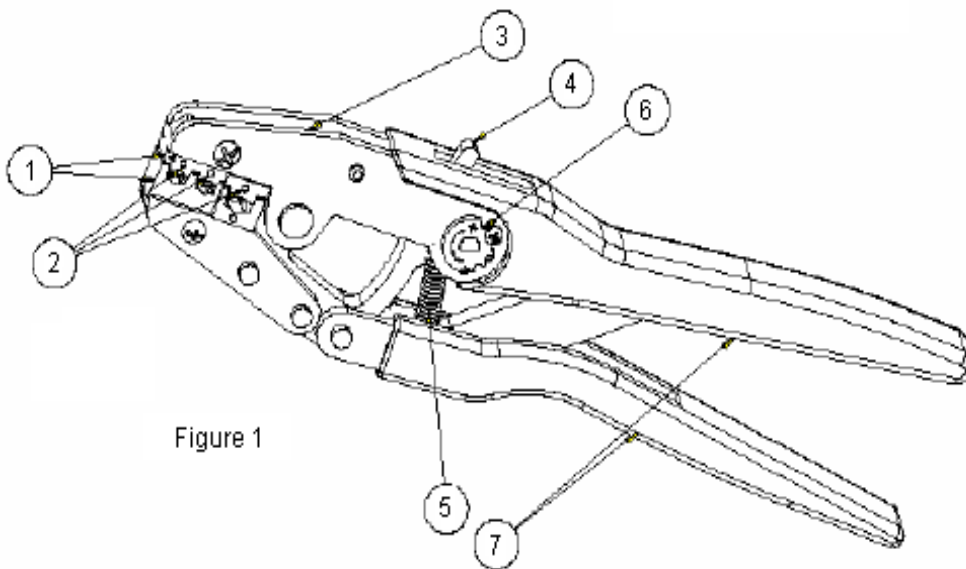

Figure 1

- 1) Die set
- 2) Die colour code
- 3) Body
- 4) Pawl release lever
- 5) Spring
- 6) Ratchet adjuster
- 7) Plastic grip

CRIMP TOOL

INSTRUCTION MANUAL



Description:

The front of the crimping dies is marked with die color code shown wire size ranges.

The tool features a fixed die (crimper) for nylon, vinyl, PC insulated terminals/connectors on 22#-10AWG stranded copper wire.

Hand tool ratchet accures full crimping of the contact.

Once engaged, the ratchet will not release until the dies have been fully closed.

Part Number Table

Description	Die Number	Part Number
Crimp Tool	DIE-1322	KST2000D-1322

Disclaimer This data sheet and its contents (the "Information") belong to the Premier Farnell Group (the "Group") or are licensed to it. No licence is granted for the use of it other than for information purposes in connection with the products to which it relates. No licence of any intellectual property rights is granted. The Information is subject to change without notice and replaces all data sheets previously supplied. The Information supplied is believed to be accurate but the Group assumes no responsibility for its accuracy or completeness, any error in or omission from it or for any use made of it. Users of this data sheet should check for themselves the Information and the suitability of the products for their purpose and not make any assumptions based on information included or omitted. Liability for loss or damage resulting from any reliance on the Information or use of it (including liability resulting from negligence or where the Group was aware of the possibility of such loss or damage arising) is excluded. This will not operate to limit or restrict the Group's liability for death or personal injury resulting from its negligence. SPC Multicomp is the registered trademark of the Group. © Premier Farnell plc 2009.

<http://www.farnell.com>
<http://www.newark.com>
<http://www.cpc.co.uk>

