



**TC1016/TC1017 LDO
Evaluation Board
User's Guide**

Note the following details of the code protection feature on Microchip devices:

- Microchip products meet the specification contained in their particular Microchip Data Sheet.
- Microchip believes that its family of products is one of the most secure families of its kind on the market today, when used in the intended manner and under normal conditions.
- There are dishonest and possibly illegal methods used to breach the code protection feature. All of these methods, to our knowledge, require using the Microchip products in a manner outside the operating specifications contained in Microchip's Data Sheets. Most likely, the person doing so is engaged in theft of intellectual property.
- Microchip is willing to work with the customer who is concerned about the integrity of their code.
- Neither Microchip nor any other semiconductor manufacturer can guarantee the security of their code. Code protection does not mean that we are guaranteeing the product as "unbreakable."

Code protection is constantly evolving. We at Microchip are committed to continuously improving the code protection features of our products. Attempts to break Microchip's code protection feature may be a violation of the Digital Millennium Copyright Act. If such acts allow unauthorized access to your software or other copyrighted work, you may have a right to sue for relief under that Act.

Information contained in this publication regarding device applications and the like is provided only for your convenience and may be superseded by updates. It is your responsibility to ensure that your application meets with your specifications. MICROCHIP MAKES NO REPRESENTATIONS OR WARRANTIES OF ANY KIND WHETHER EXPRESS OR IMPLIED, WRITTEN OR ORAL, STATUTORY OR OTHERWISE, RELATED TO THE INFORMATION, INCLUDING BUT NOT LIMITED TO ITS CONDITION, QUALITY, PERFORMANCE, MERCHANTABILITY OR FITNESS FOR PURPOSE. Microchip disclaims all liability arising from this information and its use. Use of Microchip's products as critical components in life support systems is not authorized except with express written approval by Microchip. No licenses are conveyed, implicitly or otherwise, under any Microchip intellectual property rights.

Trademarks

The Microchip name and logo, the Microchip logo, Accuron, dsPIC, KEELOQ, microID, MPLAB, PIC, PICmicro, PICSTART, PRO MATE, PowerSmart, rPIC, and SmartShunt are registered trademarks of Microchip Technology Incorporated in the U.S.A. and other countries.

AmpLab, FilterLab, Migratable Memory, MXDEV, MXLAB, PICMASTER, SEEVAL, SmartSensor and The Embedded Control Solutions Company are registered trademarks of Microchip Technology Incorporated in the U.S.A.

Analog-for-the-Digital Age, Application Maestro, dsPICDEM, dsPICDEM.net, dsPICworks, ECAN, ECONOMONITOR, FanSense, FlexROM, fuzzyLAB, In-Circuit Serial Programming, ICSP, ICEPIC, Linear Active Thermistor, MPASM, MPLIB, MPLINK, MPSIM, PICkit, PICDEM, PICDEM.net, PICLAB, PICtail, PowerCal, PowerInfo, PowerMate, PowerTool, rLAB, rPICDEM, Select Mode, Smart Serial, SmartTel, Total Endurance and WiperLock are trademarks of Microchip Technology Incorporated in the U.S.A. and other countries.

SQTP is a service mark of Microchip Technology Incorporated in the U.S.A.

All other trademarks mentioned herein are property of their respective companies.

© 2005, Microchip Technology Incorporated, Printed in the U.S.A., All Rights Reserved.

 Printed on recycled paper.

**QUALITY MANAGEMENT SYSTEM
CERTIFIED BY DNV**



Microchip received ISO/TS-16949:2002 quality system certification for its worldwide headquarters, design and wafer fabrication facilities in Chandler and Tempe, Arizona and Mountain View, California in October 2003. The Company's quality system processes and procedures are for its PICmicro® 8-bit MCUs, KEELOQ® code hopping devices, Serial EEPROMs, microperipherals, nonvolatile memory and analog products. In addition, Microchip's quality system for the design and manufacture of development systems is ISO 9001:2000 certified.



**TC1016/TC1017 EVALUATION
BOARD USER'S GUIDE**



TC1016/TC1017 Evaluation Board User's Guide

NOTES:

Preface

NOTICE TO CUSTOMERS

All documentation becomes dated, and this manual is no exception. Microchip tools and documentation are constantly evolving to meet customer needs, so some actual dialogs and/or tool descriptions may differ from those in this document. Please refer to our web site (www.microchip.com) to obtain the latest documentation available.

Documents are identified with a “DS” number. This number is located on the bottom of each page, in front of the page number. The numbering convention for the DS number is “DSXXXXA”, where “XXXXX” is the document number and “A” is the revision level of the document.

INTRODUCTION

This chapter contains general information that will be useful to know before using the TC1016/TC1017 LDO Evaluation Board. Items discussed in this chapter include:

- Document Layout
- Conventions Used in this Guide
- Recommended Reading
- The Microchip Web Site
- Customer Support
- Document Revision History

DOCUMENT LAYOUT

This document describes how to use the TC1016/TC1017 LDO Evaluation Board as a development tool to emulate and debug firmware on a target board. The manual layout is as follows:

- **Chapter 1. “Product Overview”** – Important information about the TC1016/TC1017 LDO Evaluation Board.
- **Chapter 2. “Installation and Operation”** – Includes a description of the evaluation board’s operation, as well as instructions on how to get started.
- **Appendix A. “Schematic and Layout”** – Shows the schematic and layout diagrams for the TC1016/TC1017 LDO Evaluation Board.
- **Appendix B. “Bill Of Materials (BOM)”** – Lists the parts used to build the TC1016/TC1017 LDO Evaluation Board.

TC1016/TC1017 Evaluation Board User's Guide

CONVENTIONS USED IN THIS GUIDE

This manual uses the following documentation conventions:

DOCUMENTATION CONVENTIONS

Description	Represents	Examples
Arial font:		
Italic characters	Referenced books	<i>MPLAB[®] IDE User's Guide</i>
	Emphasized text	...is the <i>only</i> compiler...
Initial caps	A window	the Output window
	A dialog	the Settings dialog
	A menu selection	select Enable Programmer
Quotes	A field name in a window or dialog	"Save project before build"
Underlined, italic text with right angle bracket	A menu path	<u><i>File>Save</i></u>
Bold characters	A dialog button	Click OK
	A tab	Click the Power tab
Text in angle brackets < >	A key on the keyboard	Press <Enter>, <F1>
Courier New font:		
Plain Courier New	Sample source code	#define START
	Filenames	autoexec.bat
	File paths	c:\mcc18\h
	Keywords	_asm, _endasm, static
	Command-line options	-Opa+, -Opa-
	Bit values	0, 1
	Constants	0xFF, 'A'
Italic Courier New	A variable argument	<i>file.o</i> , where <i>file</i> can be any valid filename
Square brackets []	Optional arguments	mcc18 [options] <i>file</i> [options]
Curly brackets and pipe character: { }	Choice of mutually exclusive arguments; an OR selection	errorlevel {0 1}
Ellipses...	Replaces repeated text	var_name [, var_name...]
	Represents code supplied by user	void main (void) { ... }

RECOMMENDED READING

This user's guide describes how to use the TC1016/TC1017 LDO Evaluation Board. The following Microchip documents are available and recommended as supplemental reference resources.

TC1016 Data Sheet, "80 mA, Tiny CMOS LDO with Shutdown" (DS21666)

TC1017 Data Sheet, "150 mA, Tiny CMOS LDO with Shutdown" (DS21813)

THE MICROCHIP WEB SITE

Microchip provides online support via our web site at www.microchip.com. This web site is used as a means to make files and information easily available to customers. Accessible by using your favorite Internet browser, the web site contains the following information:

- **Product Support** – Data sheets and errata, application notes and sample programs, design resources, user's guides and hardware support documents, latest software releases and archived software
- **General Technical Support** – Frequently Asked Questions (FAQs), technical support requests, online discussion groups, Microchip consultant program member listing
- **Business of Microchip** – Product selector and ordering guides, latest Microchip press releases, listing of seminars and events, listings of Microchip sales offices, distributors and factory representatives

CUSTOMER SUPPORT

Users of Microchip products can receive assistance through several channels:

- Distributor or Representative
- Local Sales Office
- Field Application Engineer (FAE)
- Technical Support
- Development Systems Information Line

Customers should contact their distributor, representative or field application engineer (FAE) for support. Local sales offices are also available to help customers. A listing of sales offices and locations is included in the back of this document.

Technical support is available through the web site at: <http://support.microchip.com>

DOCUMENT REVISION HISTORY

Revision A (September 2005)

- Initial Release of this Document

TC1016/TC1017 Evaluation Board User's Guide

NOTES:

Chapter 1. Product Overview

1.1 INTRODUCTION

The TC1016/TC1017 LDO Evaluation Board is used to evaluate Microchip's TC1016 and TC1017, 80 mA and 150 mA, Low-Dropout (LDO) regulators. This evaluation board contains one circuit for the 5-pin SC-70 package (3.0V output voltage device) and one for the 5-pin SOT-23 package (1.8V output voltage device). Any output voltage version of either device can be used in both circuits. Both LDOs on the TC1016/TC1017 LDO Evaluation Board are the TC1017 device.

This chapter covers the following topics:

- What is the TC1016/TC1017 LDO Evaluation Board?
- What the TC1016/TC1017 LDO Evaluation Board Kit Includes.

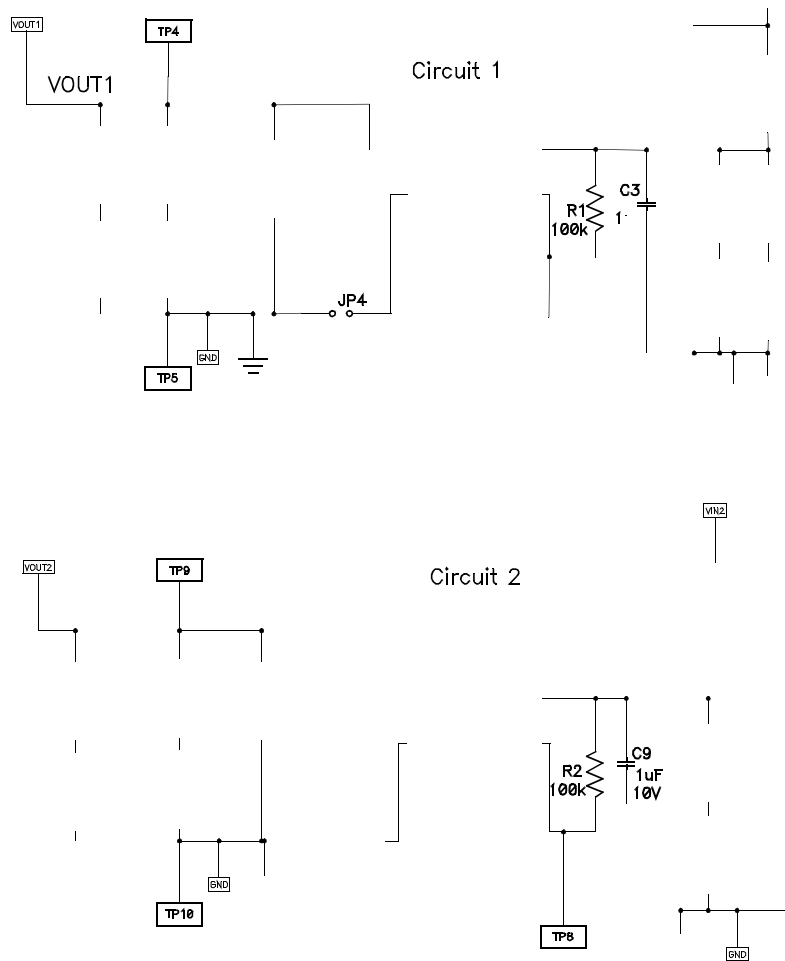

FIGURE 1-1: TC1016/TC1017 LDO Evaluation Board Schematic (LDO Circuits).

TC1016/TC1017 Evaluation Board User's Guide

1.2 WHAT IS THE TC1016/TC1017 LDO EVALUATION BOARD?

The TC1016/TC1017 LDO Evaluation Board is a tool that allows the user to evaluate fixed-voltage versions of both the TC1016 (80 mA LDO) and the TC1017 (150 mA LDO) devices in the 5-pin SC-70 and SOT-23 packages. Fixed voltage values between 1.2V and 5.0V are available for both the TC1016 and TC1017 LDOs.

Input and output capacitor values of 1 μ F are hard-wired on the board, while onboard jumpers allow you to add additional capacitance values of 4.7 μ F and 10 μ F for input and output capacitance for each circuit. Onboard jumpers also provide measurement points for input current and LDO ground current.

Line and load step circuitry are also provided on the board. Onboard jumpers allow you to move the line and load step to either Circuit 1 or Circuit 2. Shutdown input connections are also provided with onboard pull-up resistors so that the device will power-up as soon as the input voltage is provided.

Test points are provided for the LDO input voltage, output voltage, ground and shutdown input connections.

1.3 WHAT THE TC1016/TC1017 LDO EVALUATION BOARD KIT INCLUDES

This TC1016/TC1017 LDO Evaluation Board Kit includes:

- The TC1016/TC1017 LDO Evaluation Board (103-00073)
- TC1016/TC1017 LDO Evaluation Board User's Guide (DS51580)
- TC1016 Data Sheet (DS21666)
- TC1017 Data Sheet (DS21813)

Chapter 2. Installation and Operation

2.1 INTRODUCTION

The TC1016/TC1017 LDO Evaluation Board allows the user to evaluate Microchip's 80 mA (TC1016) and 150 mA (TC1017) Low-Dropout (LDO) regulators. The evaluation board contains two independent LDO circuits that allow the user to evaluate the TC1016 and TC1017 devices in the 5-pin SC-70 and SOT-23 packages. The evaluation board is populated with a TC1017 1.8V output voltage device (SOT-23 circuit) and a TC1017 3.0V output voltage device (SC-70 circuit). Any of the available output voltage values of the devices (1.2V to 5.0V) can be used on this board. Fixed input and output capacitor values of 1.0 μ F are hard-wired on the board, while values of 4.7 μ F and 10 μ F can be selected via jumpers. Line and load step circuitry is also provided.

2.2 FEATURES

The TC1016/TC1017 LDO Evaluation Board has the following features:

- Input voltage range: 2.7V to 6.0V
- Additional input and output capacitor value selection capability via jumpers (4.7 μ F and 10 μ F values)
- Output voltage shutdown via the $\overline{\text{SHDN}}$ inputs
- Overcurrent protection (device feature)
- Overtemperature protection (device feature)
- Line and load step testing capability

2.3 GETTING STARTED

The TC1016/TC1017 LDO Evaluation Board is fully assembled and tested over its input voltage and output current operating range. This board requires the use of an external input voltage source (+2.7V to +6.0V) and an external load (electronic or resistive). The Printed Circuit Board (PCB) design provides cooling for the LDO devices via onboard copper. If the devices are operated with high power dissipation (large input-to-output voltage differential and maximum output current), additional cooling may be required to keep the devices from going into overtemperature shutdown.

The TC1016/TC1017 LDO Evaluation Board contains two evaluation circuits: one for the SC-70 package and one for the SOT-23 package. The board has both positions populated with the TC1017 LDO. Circuit 1 (U1) has the 3.0V output voltage version of the device (TC1017-3.0VLT) in the SC-70 package, while Circuit 2 (U2) has the 1.8V output voltage version (TC1017-1.8VCT) in the SOT-23 package. The TC1016 LDO can be used in either circuit since it has the same pinout in each package.

The LDO circuits are powered independent of each other through separate connectors/test points. The circuitry for evaluating the SC-70 package is referenced on the schematic as Circuit 1, while the circuitry for evaluating the SOT-23 package is referenced as Circuit 2. The ground connections for the board are all common to each other. There are a total of four connection (test) points for ground for the LDO circuits (TP2, TP5, TP7 and TP10).

TC1016/TC1017 Evaluation Board User's Guide

The line step circuit can be used to provide pulsed input voltages to the LDO circuits. Either LDO circuit can be connected to the line step circuitry by populating a simple jumper post on either JP15 or JP16.

The load step circuit can be used to provide step loads to the output of the LDO circuits. Either LDO circuit can be connected to the load step circuitry by populating a simple jumper post on either JP13 or JP14.

Additional input and output capacitance values can also be added to the LDO circuits by populating jumper posts. Capacitor values of 4.7 μ F and 10 μ F are available on both the input and output of the LDO.

All of the connections to the TC1016/TC1017 LDO Evaluation Board are made through surface-mount test points. These test points can be removed with a soldering iron if you want to solder wires directly to the pads on the board.

2.4 TESTING CIRCUIT 1 OF THE TC1016/TC1017 LDO Evaluation Board

2.4.1 Power Input and Output Connections

2.4.1.1 POWERING THE TC1016/TC1017 LDO EVALUATION BOARD

1. Apply the input voltage to test points TP1 (VIN1) and TP2 (GND). Connect the positive side of the input source (+) to TP1 (VIN1). Connect the negative, or return, side (-) of the input source to the GND terminal (TP2). These two test points are located on the upper-left side of the board. The power supply input voltage must be in the specified operating range for the board to operate properly (2.7V to 6.0V).
2. When an input voltage is applied and is within the operating voltage range of the LDO, the LDO output will turn on automatically. The SHDN1 input (TP3) has been pulled up to VIN1, which turns the device on. The LDO output can be turned off by pulling TP3 low. This can be accomplished by connecting TP3 to either TP2 or TP10 (the two nearest ground connection points).

2.4.1.2 APPLYING THE LOAD TO THE TC1016/TC1017 LDO EVALUATION BOARD

1. To apply a load to VOUT1 of the TC1016/TC1017 LDO Evaluation Board, the positive side of the load (+) should be connected to TP4 (VOUT1). The negative side of the load should be connected to TP5 (GND).
2. The maximum output current of the TC1016 is 80 mA, while the maximum output current of the TC1017 is 150 mA. If the output load exceeds these respective levels, the TC1016 and TC1017 will go into Current Limit mode (see device data sheets for more details). If, during the Overload condition, the device junction temperature exceeds the overtemperature limit of 150°C, the output of the LDO will turn off and wait for the junction temperature to cool down before turning the LDO output back on.

2.4.2 Changing Input and Output Capacitor Values of the LDO

The TC1016/TC1017 LDO Evaluation Board comes with 1 μF , 4.7 μF and 10 μF input and output capacitor values. The 1 μF input and output capacitor are always connected. The 4.7 μF and 10 μF input and output capacitor values can be selected by populating jumpers on the board. To select the 4.7 μF input capacitor, populate jumper JP3. To select the 10 μF input capacitor, populate jumper JP2. The shorting jumper hats provided for Circuit 2 can be used to make these connections. To select the 4.7 μF output capacitor, populate JP5. To select the 10 μF output capacitor, populate JP6.

2.4.3 Measuring Quiescent Current and Ground Current

As you will see by looking at the TC1016/TC1017 LDO Evaluation Board schematic, Circuit 1 has jumper positions that are in series with the input voltage connection (JP1) to the LDO and in series with the ground connection (JP4). These jumper positions have been populated with jumper hats to complete the input voltage and ground path connections. If you would like to measure the quiescent current or ground current of the LDO, the jumper hats can be removed to allow for multi-meters to be placed in series with these connections in order to measure input current (JP1) and LDO ground current (JP4).

TC1016/TC1017 Evaluation Board User's Guide

2.5 TESTING CIRCUIT 2 OF THE TC1016/TC1017 LDO Evaluation Board

2.5.1 Power Input and Output Connections (Refer to Figure 2-1)

2.5.1.1 POWERING THE TC1016/TC1017 LDO EVALUATION BOARD

1. To apply the input voltage to TP6 (VIN2) and TP7 (GND), connect the positive side of the input source (+) to TP6 (VIN2) and connect the negative, or return, side (-) of the input source to TP7 (GND). These two test points are located in the upper-right side of the board. The power supply input voltage must be in the specified operating range for the board to operate properly (2.7V to 6.0V).
2. When input voltage is applied and is within the operating voltage range of the LDO, the LDO output will turn on automatically. The SHDN2 input (TP8) has been pulled up to VIN2, which turns the device on. The LDO output can be turned off by pulling TP8 low. This can be done by connecting TP8 to either TP7 or TP10 (the two nearest ground connection points).

2.5.1.2 APPLYING THE LOAD TO THE TC1016/TC1017 LDO EVALUATION BOARD

1. To apply a load to VOUT2 of the TC1016/TC1017 LDO Evaluation Board, the positive side of the load (+) should be connected to TP9 (VOUT2). The negative side of the load should be connected to TP10 (GND).
2. The maximum output current of the TC1016 is 80mA and the maximum output current of the TC1017 is 150 mA. If the output load exceeds these respective levels, the TC1016 and TC1017 will go into Current Limit mode (see device data sheets for more details). If, during the Overload condition, the device junction temperature exceeds the overtemperature limit of 150°C, the output of the LDO will turn off and wait for the junction temperature to cool down before turning the LDO output back on.

2.5.2 Changing Input and Output Capacitor Values of the LDO

The TC1016/TC1017 LDO Evaluation Board comes with 1 μ F, 4.7 μ F and 10 μ F input and output capacitor values. The 1 μ F input and output capacitors are always connected. The 4.7 μ F and 10 μ F input and output capacitor values can be selected by populating jumpers on the board. To select the 4.7 μ F input capacitor, populate jumper JP9. To select the 10 μ F input capacitor, populate jumper JP8. The shorting jumper hats provided for Circuit 1 can be used to make these connections. To select the 4.7 μ F output capacitor, populate JP11. To select the 10 μ F output capacitor, populate JP12.

2.5.3 Measuring Quiescent Current and Ground Current

As you will see by looking at the TC1016/TC1017 LDO Evaluation Board schematic, Circuit 2 has jumper positions that are in series with the input voltage connection (JP7) to the LDO and in series with the ground connection (JP10). These jumper positions have been populated with jumper hats to complete the input voltage and ground path connections. If you would like to measure the quiescent current or ground current of the LDO, the jumper hats can be removed to allow for multi-meters to be placed in series for these connections in order to measure input current (JP7) and LDO ground current (JP10).

2.6 USING THE LINE AND LOAD STEP CIRCUITRY

Line and load step circuitry has been provided on the TC1016/TC1017 LDO Evaluation Board to make line and load step testing easy. The following sections will describe how to connect to the line and load step circuits, as well as how to connect those circuits to the LDO input or output for testing.

2.7 LINE STEP TESTING

2.7.1 Powering the Line Step Circuitry (Refer to Figure 2-1)

The line step circuitry on the board requires three power supplies and one input signal. The first power supply is the high point of the step voltage to be applied to the LDO input. The second power supply is the low point of the step voltage, while the third power supply is the bias voltage for the MOSFET driver that turns the gates of the external transition FET on and off.

The high value of the input voltage step should be connected to test points TP15 and TP16. The positive voltage is connected to TP16 and the ground lead should be connected to TP15. This voltage represents the high value of the input step voltage and should not exceed 6.0V. These test points are located in the lower-left corner of the board.

The low value of the input voltage step should be connected to TP14 and TP15. The positive voltage is connected to TP14, while the ground lead should be connected to TP15. This voltage represents the low value of the input step voltage. These test points are located in the lower-left corner of the board.

The bias voltage for the MOSFET driver should be connected to TP11 and TP12. The positive voltage is connected to TP11, while the ground lead is connected to TP12. These test points are located in the middle of the bottom edge of the board. The bias voltage for the driver should be above 5V. A bias voltage of 10V is suggested to provide good gate drive to the transition MOSFETs. The bias voltage to the driver should not exceed 15V.

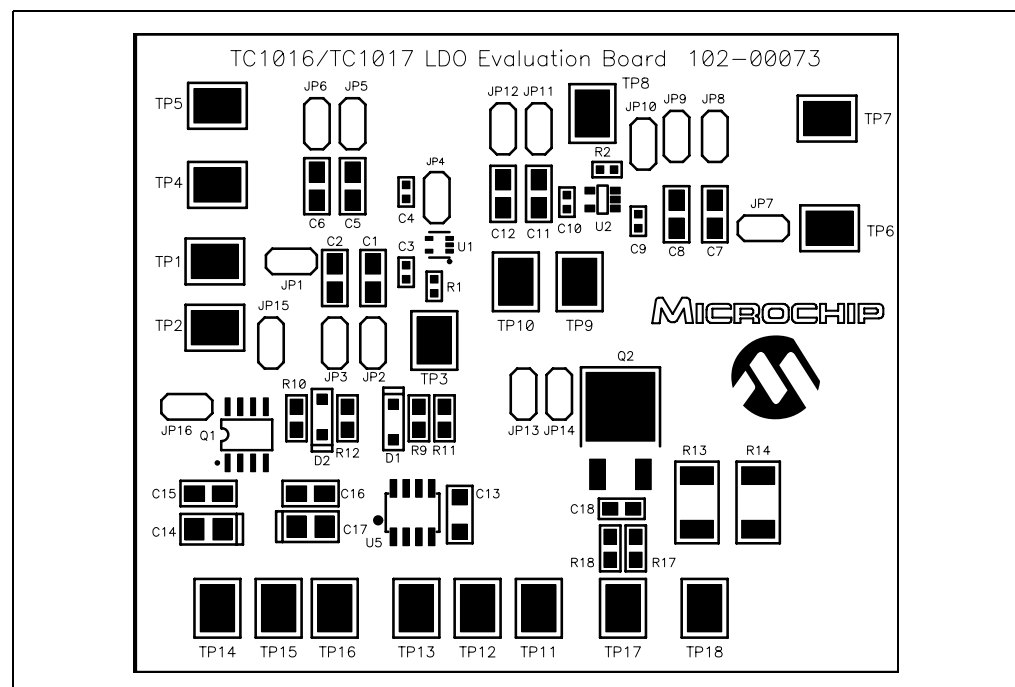

FIGURE 2-1: TC1016/TC1017 LDO Evaluation Board Assembly Layout.

2.7.2 Applying the Input Signal to the Line Step Circuit (Refer to Figure 2-1)

The input signal to the line step circuit controls the pulse voltage waveform that is applied to the input of the LDO. A pulsed rectangular waveform should be used as the input signal to the line step circuitry. This waveform can be generated easily using any pulse/function generator. The positive voltage of the input signal should be connected to TP13. The ground lead of the pulse input signal can be connected to TP12 or any other ground on the board. An input signal level of anywhere between 3.0V and the bias voltage to the MOSFET driver is acceptable.

Varying the duty cycle and frequency of the input signal for the line step pulse will control the duty cycle and frequency of the step voltage that is applied to the LDO.

2.7.3 Connecting the Step Voltage to the LDO Input (Refer to Figure 2-1)

The step voltage being generated by the line step circuitry can be connected to Circuit 1 and Circuit 2 by using jumpers JP15 and JP16, respectively.

- If you want to apply the line step voltage to Circuit 1, populate JP15. This will connect the output of the transition MOSFET Q1 to the input voltage VIN1 of Circuit 1.
- If you want to apply the line step voltage to Circuit 2, populate JP16. This will connect the output of the transition MOSFET Q1 to the input voltage VIN2 of Circuit 2.

It is always a good idea to monitor the input voltage step waveform before applying it to the LDO circuitry in order to ensure that the voltages are at the proper levels.

An example of a line step setup is shown below:

- Low-Level Bias Voltage = 3.3V (connect to TP14 and TP15 (GND))
- High-Level Bias Voltage = 5.0V (connect to TP16 and TP15 (GND))
- Bias Voltage for MOSFET Driver = 10.0V (connect to TP11 and TP12 (GND))
- Input Signal for Line Step Pulse = 0.0V to 3.0V pulse, 50% duty cycle, 50 Hz (connect to TP13 and TP12 (GND))

2.8 LOAD STEP TESTING

The load step circuitry supplied on the board consists of a N-channel MOSFET and two load resistors (2.0 ohms each).

2.8.1 Supplying the Input Signal to the Load Step Circuit

The input signal for the load step circuit is connected to TP17 (positive side) and TP18 (ground lead). This signal should be supplied by a function-generator that allows you to vary the amplitude, frequency and duty cycle of the signal.

The frequency and duty cycle of the load step applied to the LDO is controlled by the input signal that turns the gate of MOSFET Q2 on and off. The frequency and duty cycle of the load step can be adjusted to meet the requirements of your system.

The amplitude of the input signal will control the amplitude of the load step. Start with the amplitude of the input signal set to 1.0V. Monitor the input signal with an oscilloscope and use it as your trigger waveform.

The load step amplitude can be monitored by using an oscilloscope current probe. In order to measure the load step being applied to Circuit 1, connect the pins of JP13 together using a jumper wire (make a loop of wire big enough to allow for the passage of the oscilloscope probe). Use the current probe of the oscilloscope to measure the current flowing through the jumper wire. Continue to increase the voltage amplitude of the input signal until you see a step load of current. The input amplitude will usually be above 2.5V before a step load is seen. As you continue to increase the input signal amplitude, the step load amplitude will also increase.

The load step amplitude can also be monitored by using an oscilloscope to look at the voltage across the parallel resistor combination of R13 and R14. R13 and R14 are 2.0 ohm resistors, so an 80 mA load step will create an 80 mV voltage step across this resistor pair.

The step load can be applied to Circuit 2 by connecting the pins of JP14 together with a jumper wire and repeating the above process.

If a DC offset for the load step is required (you want to perform a load step from 20 mA to 60 mA), a DC load can be attached to the output voltage connections of the LDO circuit. This should be used to provide the low-end of the load. The step load circuit can then be used to provide the remaining load to the LDO.

TC1016/TC1017 Evaluation Board User's Guide

NOTES:



TC1016/TC1017 EVALUATION BOARD USER'S GUIDE

Appendix A. Schematic and Layout

A.1 INTRODUCTION

This appendix contains the following schematics and layouts for the TC1016/TC1017 LDO Evaluation Board.

- Board Schematic
- Board Outline
- Board – Top Layer
- Board – Bottom Layer

TC1016/TC1017 Evaluation Board User's Guide

A.2 BOARD SCHEMATIC – PAGE 1

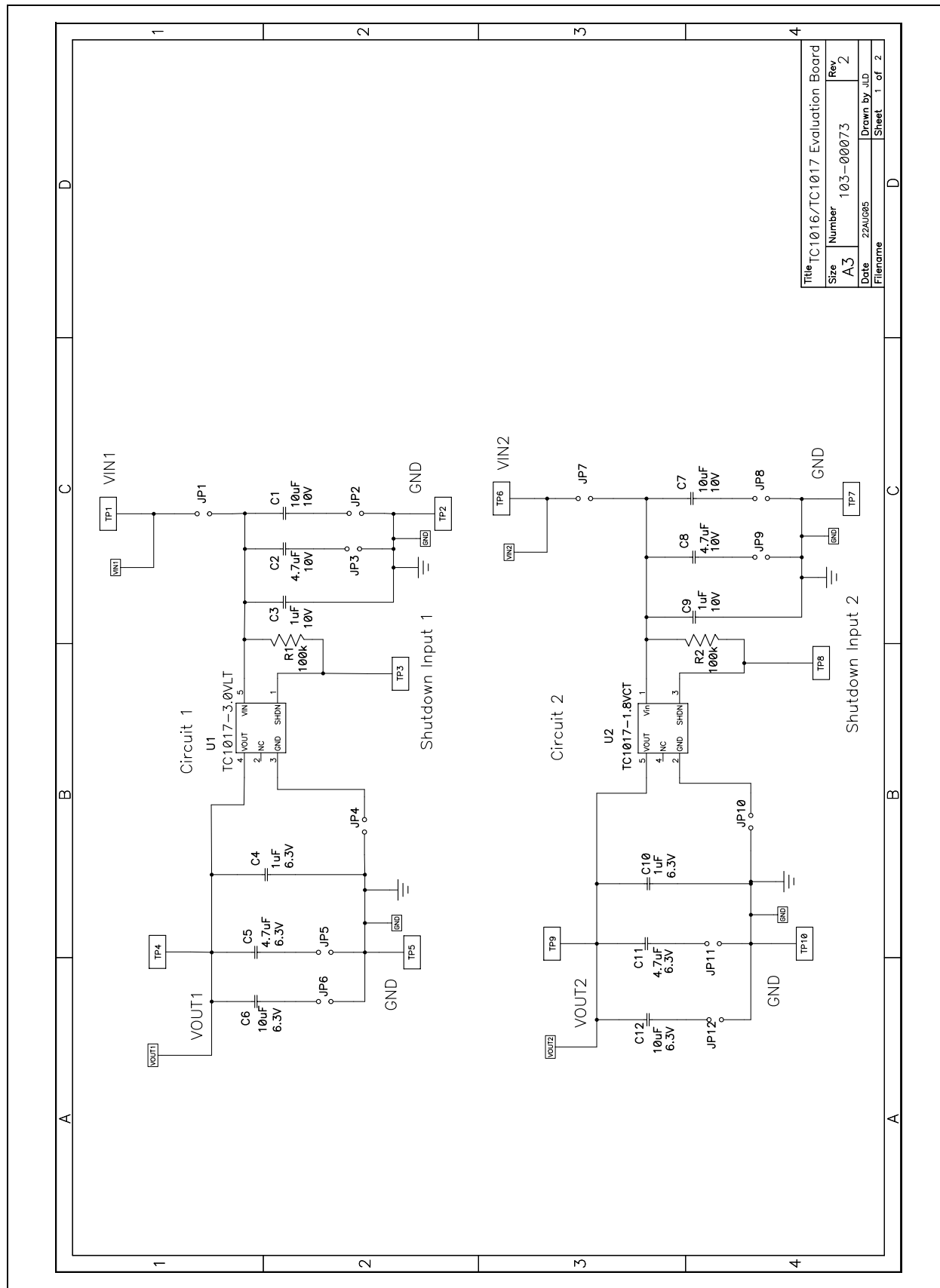

A.3 BOARD SCHEMATIC – PAGE 2

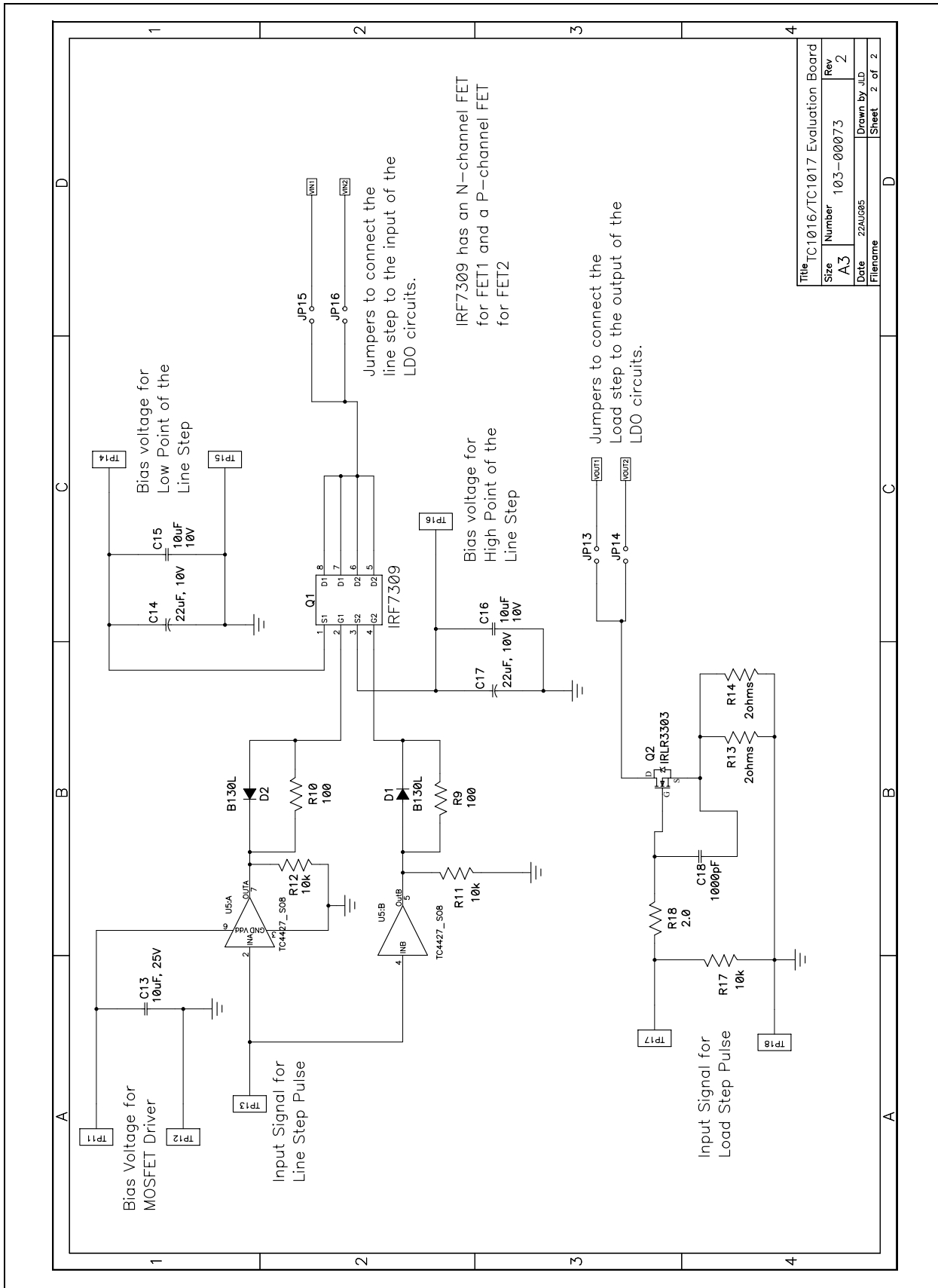

TC1016/TC1017 Evaluation Board User's Guide

A.4 BOARD – ASSEMBLY DRAWING

NOTES

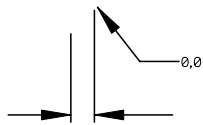

A.5 BOARD – TOP LAYER + SILK-SCREEN

A.6 BOARD – BOTTOM LAYER

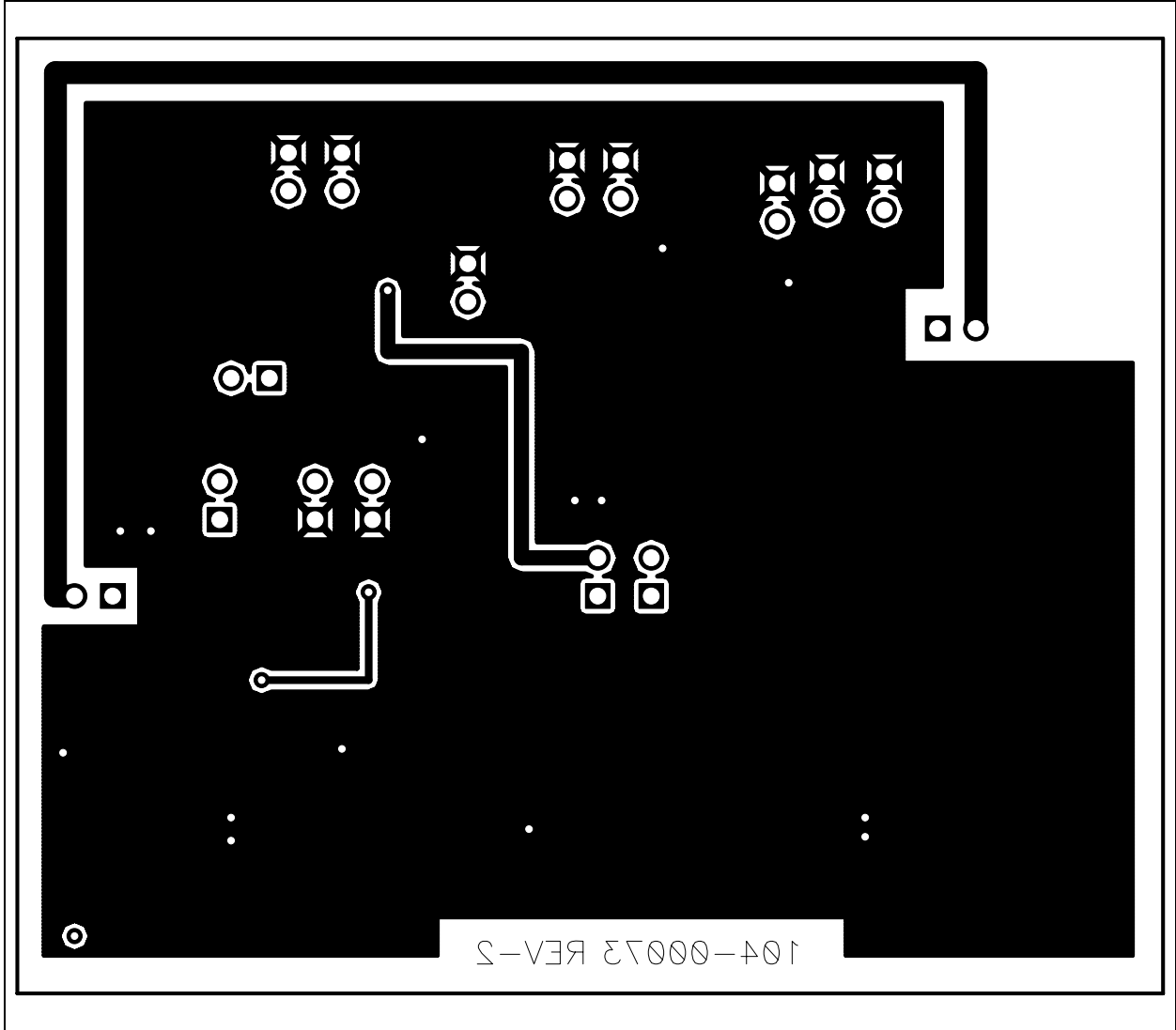

TC1016/TC1017 Evaluation Board User's Guide

NOTES:

Appendix B. Bill Of Materials (BOM)

TABLE B-1: BILL OF MATERIALS (BOM)

Qty	Reference	Description	Supplier	Part Number
4	C1, C7, C15, C16	10 UF 10V CERAMIC 1206 X5R	Panasonic®	ECJ-3YB1A106M
2	C2, C8	4.7 UF 10V CERAMIC 1206 X5R	Panasonic	ECJ-3YB1A475M
2	C3, C9	1 UF 10V CERAMIC 0603 X5R	Panasonic	ECJ-1VB1A105K
2	C4, C10	CER 1.0UF 6.3V 20% X5R 0603	Murata® Electronics	GRM188R60J105MA01D
2	C5, C11	4.7 UF 6.3V CERAMIC 0805 X5R	Panasonic	ECJ-2FB0J475M
2	C6, C12	CER 10 UF 6.3V 10% X7R 1206	Murata Electronics	GRM31CR70J106KA01L
1	C13	CERAMIC 10 UF 25V X5R 1206	Panasonic	ECJ-3YB1E106M
2	C14, C17	TANT 22 UF 10V 20% SMD	Kemet Electronics	T491A226M010AS
1	C18	1000 PF 50V CERM CHIP 0805	Panasonic	ECJ-2VB1H102K
2	D1, D2	SCHOTTKY 1A 30V SOD123	Diodes Inc	B130LAW-7-F
16	JP1, JP2, JP3, JP4, JP5, JP6, JP7, JP8, JP9, JP10, JP11, JP12, JP13, JP14, JP15, JP16	CONN HEADER .100 SINGL STR 2POS	Sullins Electronic Corporation	PTC36SAAN
1	Q1	IRF7309	International Rectifier	IRF7309
1	Q2	IRLR3303	International Rectifier	IRLR3303
2	R1, R2	100 KOHM 1/16W 1% 0603 SMD	Panasonic	ERJ-3EKF1003V
1	R18	2.00 OHM 1/8W 1% 0805 SMD	Rohm	MCR10EZHF2R00
3	R11, R12, R17	10.0 KOHM 1/8W 1% 0805 SMD	Rohm	MCR10EZHF1002
2	R9, R10	100 OHM 1/8W 1% 0805 SMD	Rohm	MCR10EZHF1000
2	R13, R14	2.0 OHM 1W 5% 2512 SMD	Panasonic	ERJ-1TYJ2R0U
4	SJ1, SJ2, SJ3, SJ4	Shorting Jumpers	Sullins Electronic Corporation	STC02SYAN
18	TP1, TP2, TP3, TP4, TP5, TP6, TP7, TP8, TP9, TP10, TP11, TP12, TP13, TP14, TP15, TP16, TP17, TP18	TEST POINT COMPACT SMT	Keystone Electronics®	5016
1	U1	TC1017-SC70-5, 3.0V Output	Microchip Technology Inc.	TC1017-3.0VLTTR
1	U2	TC1017-SOT23-5, 1.8V Output	Microchip Technology Inc.	TC1017-1.8VCTTR
1	U5	MOSFET DVR 1.5A DUAL 8-SOIC	Microchip Technology Inc.	TC4427EOA713



WORLDWIDE SALES AND SERVICE

AMERICAS

Corporate Office
2355 West Chandler Blvd.
Chandler, AZ 85224-6199
Tel: 480-792-7200
Fax: 480-792-7277
Technical Support:
<http://support.microchip.com>
Web Address:
www.microchip.com

Atlanta
Alpharetta, GA
Tel: 770-640-0034
Fax: 770-640-0307

Boston
Westborough, MA
Tel: 774-760-0087
Fax: 774-760-0088

Chicago
Itasca, IL
Tel: 630-285-0071
Fax: 630-285-0075

Dallas
Addison, TX
Tel: 972-818-7423
Fax: 972-818-2924

Detroit
Farmington Hills, MI
Tel: 248-538-2250
Fax: 248-538-2260

Kokomo
Kokomo, IN
Tel: 765-864-8360
Fax: 765-864-8387

Los Angeles
Mission Viejo, CA
Tel: 949-462-9523
Fax: 949-462-9608

San Jose
Mountain View, CA
Tel: 650-215-1444
Fax: 650-961-0286

Toronto
Mississauga, Ontario,
Canada
Tel: 905-673-0699
Fax: 905-673-6509

ASIA/PACIFIC

Australia - Sydney
Tel: 61-2-9868-6733
Fax: 61-2-9868-6755

China - Beijing
Tel: 86-10-8528-2100
Fax: 86-10-8528-2104

China - Chengdu
Tel: 86-28-8676-6200
Fax: 86-28-8676-6599

China - Fuzhou
Tel: 86-591-8750-3506
Fax: 86-591-8750-3521

China - Hong Kong SAR
Tel: 852-2401-1200
Fax: 852-2401-3431

China - Qingdao
Tel: 86-532-8502-7355
Fax: 86-532-8502-7205

China - Shanghai
Tel: 86-21-5407-5533
Fax: 86-21-5407-5066

China - Shenyang
Tel: 86-24-2334-2829
Fax: 86-24-2334-2393

China - Shenzhen
Tel: 86-755-8203-2660
Fax: 86-755-8203-1760

China - Shunde
Tel: 86-757-2839-5507
Fax: 86-757-2839-5571

China - Wuhan
Tel: 86-27-5980-5300
Fax: 86-27-5980-5118

China - Xian
Tel: 86-29-8833-7250
Fax: 86-29-8833-7256

ASIA/PACIFIC

India - Bangalore
Tel: 91-80-2229-0061
Fax: 91-80-2229-0062

India - New Delhi
Tel: 91-11-5160-8631
Fax: 91-11-5160-8632

India - Pune
Tel: 91-20-2566-1512
Fax: 91-20-2566-1513

Japan - Yokohama
Tel: 81-45-471-6166
Fax: 81-45-471-6122

Korea - Gumi
Tel: 82-54-473-4301
Fax: 82-54-473-4302

Korea - Seoul
Tel: 82-2-554-7200
Fax: 82-2-558-5932 or
82-2-558-5934

Malaysia - Penang
Tel: 604-646-8870
Fax: 604-646-5086

Philippines - Manila
Tel: 632-634-9065
Fax: 632-634-9069

Singapore
Tel: 65-6334-8870
Fax: 65-6334-8850

Taiwan - Hsin Chu
Tel: 886-3-572-9526
Fax: 886-3-572-6459

Taiwan - Kaohsiung
Tel: 886-7-536-4818
Fax: 886-7-536-4803

Taiwan - Taipei
Tel: 886-2-2500-6610
Fax: 886-2-2508-0102

Thailand - Bangkok
Tel: 66-2-694-1351
Fax: 66-2-694-1350

EUROPE

Austria - Weis
Tel: 43-7242-2244-399
Fax: 43-7242-2244-393

Denmark - Copenhagen
Tel: 45-4450-2828
Fax: 45-4485-2829

France - Paris
Tel: 33-1-69-53-63-20
Fax: 33-1-69-30-90-79

Germany - Munich
Tel: 49-89-627-144-0
Fax: 49-89-627-144-44

Italy - Milan
Tel: 39-0331-742611
Fax: 39-0331-466781

Netherlands - Drunen
Tel: 31-416-690399
Fax: 31-416-690340

Spain - Madrid
Tel: 34-91-352-30-52
Fax: 34-91-352-11-47

UK - Wokingham
Tel: 44-118-921-5869
Fax: 44-118-921-5820



08/24/05