

NUMBER BUS-12-087	TYPE PRODUCT SPECIFICATION		
TITLE Ribcage™ II Printed Wiring Board Connector System		PAGE 1 of 21	REVISION M
		AUTHORIZED BY C. Martinez	DATE 27 Feb 07
		CLASSIFICATION UNRESTRICTED	

1.0 GENERAL

This specification covers gold plated Rib Cage™ II Printed Wiring Board Connectors designed for parallel (vertical) interconnection of printed wiring boards in low power applications as well as Lead Free product that meets the requirement of the European Union Directives of Restriction for Hazardous Substances (Directive 2002/95/EC).

The receptacle assemblies (Figure 1) are designed for mating with shrouded headers (Figure 2) having double rows of .018 inch formed pins on .050 inch centers. This specification is composed of the following sections:

<u>Paragraph</u>	<u>Title</u>	<u>Page</u>
1.0	GENERAL	1
2.0	APPLICABLE DICUMENTS	1
3.0	REQUIREMENTS	2
3.1	Qualification	2
3.2	Materials-Receptacle Assemblies	2
3.3	Materials-Shrouded Headers	3
3.4	Design and Construction	3
3.5	Electrical Characteristics	3
3.6	Mechanical Characteristics	9
3.7	Environmental Conditions	11
4.0	PRODUCT QUALIFICATION PROVISIONS	15
4.1	Equipment Calibration	15
4.2	Inspection Conditions	15
4.3	Qualification Inspection	15
4.4	Requalification Testing	15

2.0 APPLICABLE DOCUMENTS

The following documents, of the issue in effect on the date of the latest revision of this specification, shall form a part of this specification to the extent specified herein.

SPECIFICATIONS

Federal

QQ-S-571 Solder: Lead Alloy, Tin-lead Alloy, and Tin Alloy; Flux cored Ribbon and Wire, Solid Form

QQ-N-290 Nickel Plating, Electrodeposited

Military

MIL-F-14256 Flux, Soldering, Liquid (Rosin Base), Activated
MIL-M-24519 Molding Plastics, Polyester, Thermoplastic
MIL-G-45204 Gold Plating, Electrodeposited
MIL-C-45662 Calibration System Requirement
MIL-F-55110 Printed Wiring Boards

NUMBER BUS-12-087	TYPE PRODUCT SPECIFICATION		
TITLE Ribcage™ II Printed Wiring Board Connector System		PAGE 2 of 21	REVISION M
		AUTHORIZED BY C. Martinez	DATE 27 Feb 07
		CLASSIFICATION UNRESTRICTED	

STANDARDS

Military

MIL-STD-202	Test Methods for Electronic and Electrical Component Parts
MIL-STD-275	Printing Wiring for Electronic Equipment
MIL-STD-1344	Test Methods for Electrical Connectors

INDUSTRY SPECIFICATIONS/STANDARDS

ASTM B-194	Copper-Beryllium alloy Plate, Sheet, Strip, and Rolled Bar
UL-94	Tests for Flammability of Plastic Materials

3.0 REQUIREMENTS

3.1 Qualification

Connectors (Figure 1) and headers (Figure 2) furnished under this specification shall be products capable of meeting the qualification test requirements specified herein. New products of the same type shall be considered qualified by similarity pending actual testing.

3.2 Connector Materials

The material for each part shall be as specified herein, or equivalent. Substitute material shall meet the performance requirements of this specification.

3.2.1 Contact - The contact shall be full hard (HM) Beryllium Copper.

3.2.2 Insulator Housing - All housing material shall be rated flame retardant 94 V0 in accordance with UL-94. The housing shall be glass filled thermoplastic in accordance with MIL-M-24519.

3.2.3 Contact Finish - The contact shall be plated in the contact area with 30 microinches (minimum) gold per MIL-G-45204, Type II, Grade C, over nickel, per QQ-N-290, Class 2. In the soldering area the contact shall be tin/lead plated 100 microinches min. over Nickel or pure tin plated 100 microinches min. over Nickel.

NUMBER BUS-12-087	TYPE PRODUCT SPECIFICATION		
TITLE Ribcage™ II Printed Wiring Board Connector System		PAGE 3 of 21	REVISION M
		AUTHORIZED BY C. Martinez	DATE 27 Feb 07
		CLASSIFICATION UNRESTRICTED	

3.3 Header Materials

3.3.1 Pin - The pin shall be 1/2 hard phosphor bronze.

3.3.2 Insulator Housing - All housing material shall be rated flame retardant 94 V0 in accordance with UL-94. The housing shall be glass filled thermoplastic, minimum heat deflection temperature 500 degrees F @ 264 PSI in accordance with MIL-M-24519.

3.3.3 Pin Finish - The pin shall be plated with 30 microinches (minimum) gold per MIL-G-45204, Type II Grade C over 50 microinches (minimum) nickel per QQ-N-290 Class 2 in the contact area. In the soldering area the pin shall be tin/lead plated 100 microinches min. over Nickel or pure tin plated 100 microinches min. over Nickel.

3.4 Design and Construction

The connector shall be a multi-piece assembly having two rows of contacts with solder tail terminations for installation in .023 inch diameter holes in a 1/16 inch thick printed wiring board. The female end of the contact shall interface with 0.018 inch formed pins on .050 inch centers, as appropriate.

3.4.1 Mating - The connector shall be capable of mating with a maximum of 5.5 oz and minimum of 1.5 oz per position.

3.4.2 Workmanship - Connectors shall be uniform in quality and shall be free from defects that will adversely affect life or serviceability.

3.4.3 Interchangeability - Connectors shall be capable of mating with any FCI approved .050 inch center header.

3.5 Electrical Characteristics

3.5.1 Current Rating - The temperature rise above ambient shall not exceed 30°C at any point in the system when all contacts are powered at 1.0 ampere or when one contact is powered at 2.5 amperes. The following details shall apply:

- a. Ambient Conditions - Still air at 25°C.
- b. Reference - BUS-03-601

NUMBER BUS-12-087	TYPE PRODUCT SPECIFICATION		
TITLE Ribcage™ II Printed Wiring Board Connector System		PAGE 4 of 21	REVISION M
		AUTHORIZED BY C. Martinez	DATE 27 Feb 07
		CLASSIFICATION UNRESTRICTED	

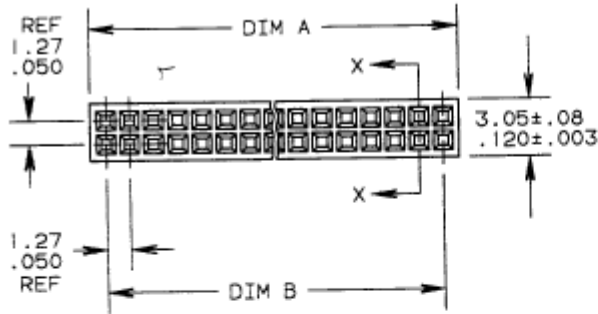

PROD NO	SIZE	DIM A	DIM B
87011-605	2 X 5	6.756/264	8.08/200
↑ -610	2 X 10	13.104/514	11.43/450
-615	2 X 15	19.456/764	17.78/700
↓ -620	2 X 20	25.806/1.016	24.13/950
-625	2 X 25	32.156/1.266	30.48/1.200
-630	2 X 30	38.506/1.516	36.83/1.450
-635	2 X 35	44.856/1.766	43.18/1.700
↓ -640	2 X 40	51.206/2.016	49.53/1.950
-645	2 X 45	57.556/2.266	55.88/2.200
87011-650	2 X 50	63.906/2.516	62.23/2.450

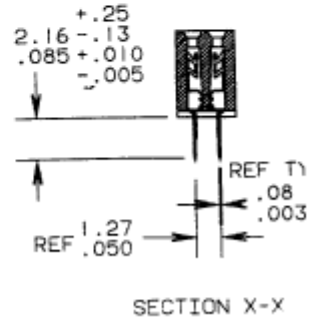
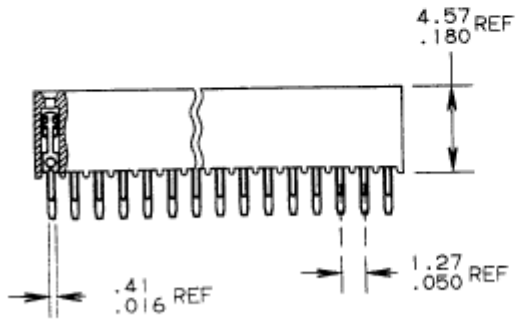

NUMBER BUS-12-087	TYPE PRODUCT SPECIFICATION		
TITLE Ribcage™ II Printed Wiring Board Connector System		PAGE 5 of 21	REVISION M
		AUTHORIZED BY C. Martinez	DATE 27 Feb 07
		CLASSIFICATION UNRESTRICTED	

FIGURE 2 - RIB CAGE™ MATING HEADER (P/N 87405)



NUMBER BUS-12-087	TYPE PRODUCT SPECIFICATION		
TITLE Ribcage™ II Printed Wiring Board Connector System		PAGE 6 of 21	REVISION M
		AUTHORIZED BY C. Martinez	DATE 27 Feb 07
		CLASSIFICATION UNRESTRICTED	

TABLE I - CONTACT RESISTANCE

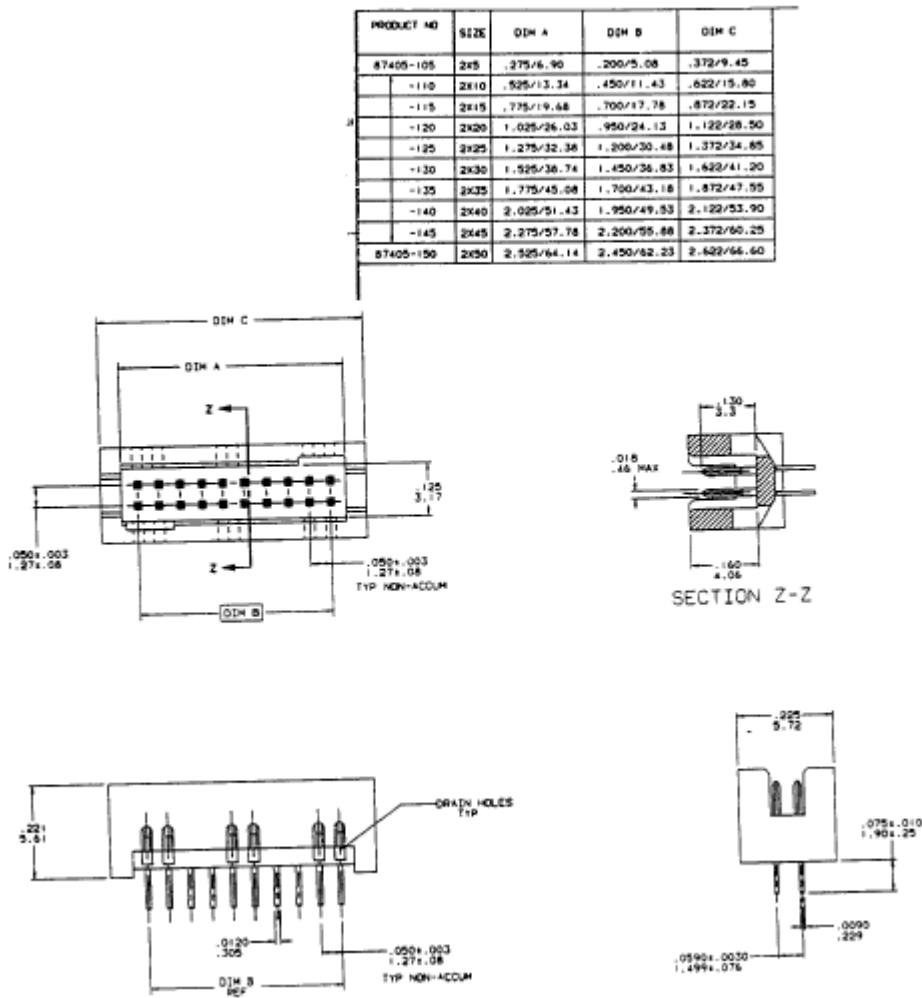
Maximum Resistance - Milliohms

<u>Maximum Resistance</u>	<u>Milliohms</u>
<u>Initial</u>	<u>After Test</u>
20	25

3.5.2 Low Level Circuit Resistance - The low level circuit resistance shall not exceed the value specified in Table I when measured using a Keithley Model 580 (or similar instrument) in the pulse mode and dry circuit conditions. The following details shall apply:

- (a) Method of connection: see Figure 3.
- (b) Test current: 100 milliamperes maximum pulsed current.
- (c) Maximum open circuit voltage: 20 millivolts.

3.5.3 Insulation Resistance - The insulation resistance of Mated/Unterminated connectors shall be not less than 50,000 megaohms (5,000 megaohms after exposure of the humidity environment described in paragraph 3.7.1) when measured in accordance with MIL-STD-202, Method 302. The following details shall apply:

- (a) Test condition: B (500 volts DC)
- (b) Special preparation: The connector shall not be terminated because of the type of printed wiring board and the geometry of its land area will affect this parameter.
- (c) Points of measurement: Between adjacent and opposing contact positions for 20 percent of connector population.

NUMBER BUS-12-087	TYPE PRODUCT SPECIFICATION		
TITLE Ribcage™ II Printed Wiring Board Connector System		PAGE 7 of 21	REVISION M
		AUTHORIZED BY C. Martinez	DATE 27 Feb 07
		CLASSIFICATION UNRESTRICTED	

3.5.4 Dielectric Withstanding Voltage - There shall be no evidence of arc-over, insulation breakdown, or excessive leakage current (>1 milliampere) when the Mated/Unterminated connectors are tested in accordance with MIL-STD-202, Method 301. The following details shall apply:

- (a) Test potential: 800 Volts AC, RMS at 60 Hz
- (b) Test duration: 60 seconds
- (c) Special preparation: The connector shall not be terminated because the type of printed wiring board and the geometry of its land area will affect this parameter.
- (d) Points of measurement: Between adjacent and opposing contact positions for 20 percent of connector population

FIGURE 3 CONTACT RESISTANCE MEASUREMENT SCHEMATIC

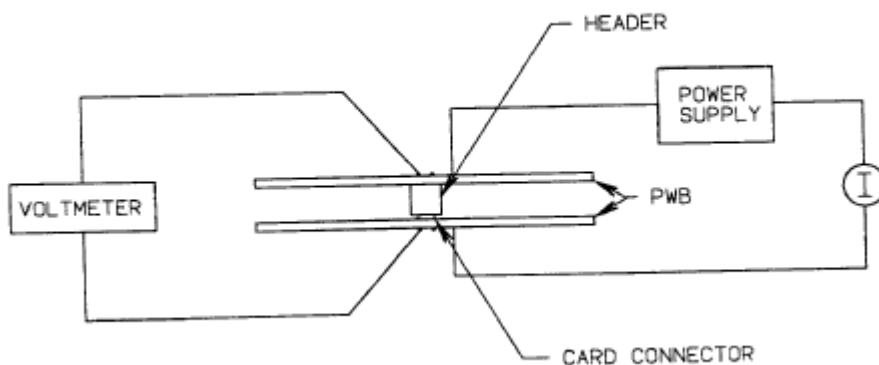

NOTE:

VOLTMETER PROBES POSITIONED ON TRACES CORRESPONDING TO POSITIONS BEING TESTED.

NUMBER BUS-12-087	TYPE PRODUCT SPECIFICATION		
TITLE Ribcage™ II Printed Wiring Board Connector System		PAGE 8 of 21	REVISION M
		AUTHORIZED BY C. Martinez	DATE 27 Feb 07
		CLASSIFICATION UNRESTRICTED	

3.5.5 Capacitance - The capacitance between pairs of adjacent or opposing contacts in an unmated connector shall not exceed 1.0 picofarad when measured in accordance with MIL-STD-202, Method 305. The following details shall apply:

- (a) Test frequency: 100 kilohertz
- (b) Special preparation: The connector shall not be terminated because of the type of printed wiring board and the geometry of its land area will affect this parameter
- (c) Sample size: 20 percent of connector population

3.6 Mechanical Characteristics

3.6.1 Contact Retention

3.6.1.1 Receptacle Assembly - Individual contacts in the unterminated connector shall withstand an axial load of 1.0 pound average (.7 pound minimum) in the direction of normal pin insertion without dislodgment.

3.6.1.2 Shrouded Header - Individual contacts in the unterminated connector shall withstand an axial load of .7 pounds Minimum in the direction of normal contact insertion without dislodgement.

3.6.2 Total Mating Force - The total force to mate the terminated connector with an appropriately populated header consisting of properly configured (see Figure 2) 0.018 inch formed pins shall be 1.5 to 5.5 ounces times the number of terminals.

3.6.3 Individual Contact Withdrawal Force - After three insertions of a properly cleaned and lubricated maximum gage pin, the force required to withdraw a properly cleaned and lubricated minimum gage, configured as shown in Figure 4, shall be not less than 10 grams.

3.6.4 Durability - After 200 mating cycles with mating header, the average contact withdrawal force shall be not less than 10 grams and the contact resistance shall not exceed the value specified in Table I (see paragraph 3.5.2).

NUMBER BUS-12-087	TYPE PRODUCT SPECIFICATION		
TITLE Ribcage™ II Printed Wiring Board Connector System		PAGE 9 of 21	REVISION M
		AUTHORIZED BY C. Martinez	DATE 27 Feb 07
		CLASSIFICATION UNRESTRICTED	

FIGURE 4 INSERTION/WITHDRAWAL STANDARD GAGE PIN



<u>DIMENSIONS-INCH</u>		
<u>GAGE</u>	<u>A. DIM</u>	<u>TOL.</u>
MIN	.0175	+ .000040 - .000000
MAX	.0180	+ .000000 - .000040

Material: Standard gage pin tool steel.

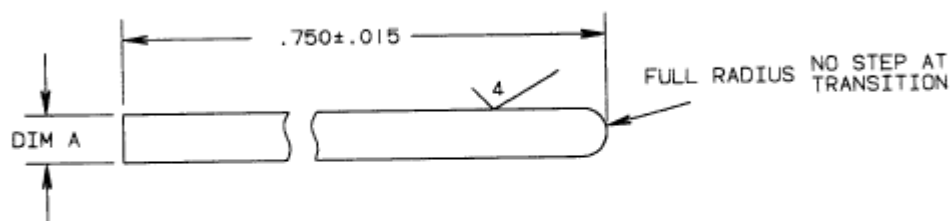
Lubricant: 10% Nye oil in 90% Isopar H by weight.

Clean and lubricate gage pin before each use as follows:

- A. Scour surface with mildly abrasive material, i.e. abrasive rubber eraser.
- B. Wash surface with alcohol and dry with clean cotton. DO NOT TOUCH SURFACE WITH FINGERS.
- C. Dip gage pin in lubricant and air dry.

NUMBER BUS-12-087	TYPE PRODUCT SPECIFICATION		
TITLE Ribcage™ II Printed Wiring Board Connector System		PAGE 10 of 21	REVISION M
		AUTHORIZED BY C. Martinez	DATE 27 Feb 07
		CLASSIFICATION UNRESTRICTED	

3.7 Environmental Conditions

3.7.1 Humidity - Within 1 hour after exposure of the connectors

to a high humidity environment, the insulation resistance of an unterminated connector shall be not less than 5000 megaohms (see paragraph 3.5.3) and the contact resistance of a terminated and mated connector shall not exceed the value specified in Table I (see paragraph 3.5.2). The test shall be in accordance with MIL-STD-202, Method 103; the following details shall apply:

- (a) Test duration: 96 hours
- (b) Relative humidity: 90% minimum
- (c) Temperature: 40⁰ C

3.7.2 Thermal Shock - After exposure of the connectors to

alternate periods of extreme high and low temperature, there shall be no evidence of cracking or crazing of the insulator housing or other physical damage to the connector; the insulation resistance shall meet paragraph 3.5.3; the dielectric withstanding voltage of an unterminated connector shall be not less than 800 volts (see paragraph 3.5.4) and the contact retention shall be not less than 0.3 pounds (see paragraph 3.6.1). The test shall be in accordance with MIL-STD-202, Method 107; the following details shall apply:

- (a) Test conditions: A-1 (25 1-hour cycles)
- (b) Temperature range: -55 to +130⁰ C

3.7.3 High Temperature Life - After exposure of the mated

connector to a high temperature operating environment, the contact resistance shall not exceed the value specified in Table I (see paragraph 3.5.2) and the insulation resistance of the connectors shall meet Section 3.5.3. The test shall be in accordance with MIL-STD-202, Method 108; the following details shall apply:

- (a) Test chamber temperature: 100⁰C
- (b) Test condition (duration): B (250 hours)
- (c) Operating conditions: Rated current (see paragraph 3.5.1) through all contacts of terminated connector; duty cycle: 45 minutes ON and 15 minutes OFF.

NUMBER BUS-12-087	TYPE PRODUCT SPECIFICATION		
TITLE Ribcage™ II Printed Wiring Board Connector System		PAGE 11 of 21	REVISION M
		AUTHORIZED BY C. Martinez	DATE 27 Feb 07
		CLASSIFICATION UNRESTRICTED	

3.7.4 Shock - There shall be no evidence of physical or mechanical damage when the mated connector is subjected to transient accelerations. During and after each shock, the contacts shall evidence no discontinuity greater than 1 microsecond. The test shall be in accordance with MIL-STD-202, Method 213; the following details shall apply:

- (a) Test condition: A (50G, 11 ms half-sine)
- (b) Number of shocks: 3 shocks in each direction along three orthogonal axes (18 total)
- (c) Mounting: see Figure 5

3.7.5 Vibration - There shall be no evidence of physical or mechanical damage when the mated connector is subjected to prolonged mechanical vibration; during the vibration along each axis, the contacts shall evidence no discontinuity greater than 1 microsecond. At the completion of the test, the contact resistance shall not exceed the value specified in Table 1 (see paragraph 3.5.2). The test shall be in accordance with MIL-STD-202, Method 204; the following details shall apply:

- (a) Test condition: B (+_ 15G, 10 to 2,000 Hz)
- (b) Test duration: 4 hours along each of three orthogonal axes (12 hours total)
- (c) Mounting: See Figure 5.

3.7.6 Hydrogen Sulfide (H₂S) Exposure - After exposure of the mated connector to a moist H₂S atmosphere, the low level circuit resistance shall not exceed the value specified in Table 1 (see paragraph 3.5.2). The following details shall apply:

- (a) Test medium: 3PPM H₂S chemically produced in a moist environment (desiccator)
- (b) Test temperature: 40⁰ C
- (c) Test duration: 48 hours



NUMBER BUS-12-087	TYPE PRODUCT SPECIFICATION		
TITLE Ribcage™ II Printed Wiring Board Connector System		PAGE 12 of 21	REVISION M
		AUTHORIZED BY C. Martinez	DATE 27 Feb 07
		CLASSIFICATION UNRESTRICTED	

FIGURE 5 RIB-CAGE™ SHOCK AND VIBRATION TEST FIXTURE #SF 169.09

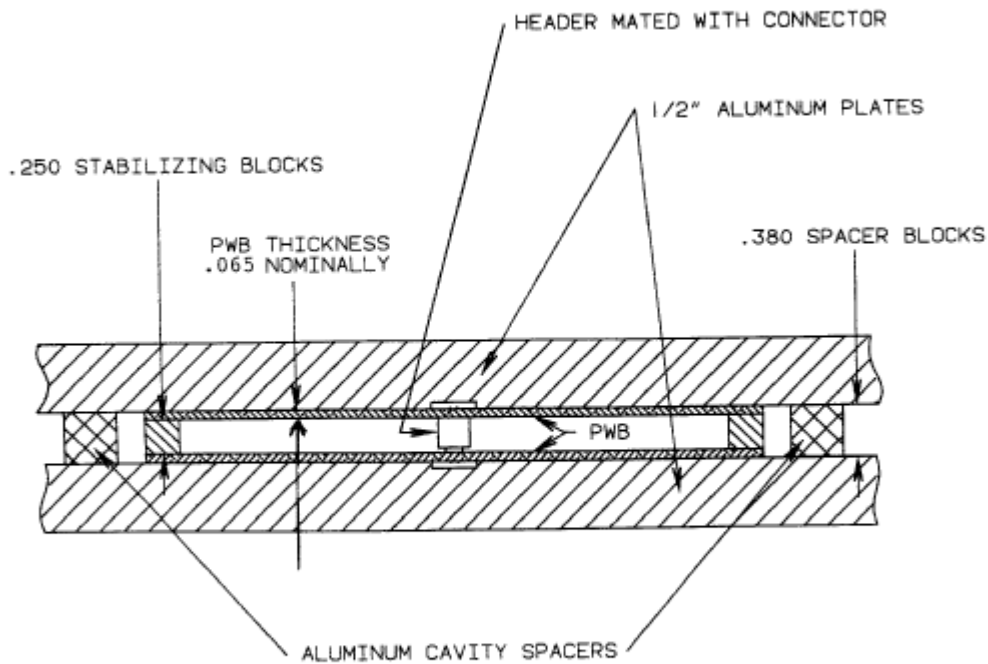

PWB'S MEASURE .365 OUTSIDE TO OUTSIDE AND ARE CLAMPED BETWEEN THE 1/2" ALUMINUM PLATES WITH SPACER BLOCKS MEASURING .380.

NUMBER BUS-12-087	TYPE PRODUCT SPECIFICATION		
TITLE Ribcage™ II Printed Wiring Board Connector System		PAGE 13 of 21	REVISION M
		AUTHORIZED BY C. Martinez	DATE 27 Feb 07
		CLASSIFICATION UNRESTRICTED	

3.7.7 Salt Spray - After exposure of the mated connector to a salt fog atmosphere, the low level circuit resistance shall not exceed the value specified in Table 1 (see paragraph 3.5.2). The test shall be in accordance with MIL-STD-202, Method 101; the following test details shall apply:

- (a) Salt solution: 5 percent by weight
- (b) Test condition: B (48 hours)

3.7.8 Solderability - The minimum tail length solderable on both the receptacle assemblies and headers shall be up to the standoffs on the respective housings. The test shall be similar to MIL-STD-202, Method 208; the following details shall apply:

- (a) Aging: suspended 2 inches above boiling distilled water for 60 minutes.
- (b) Acceptable Coverage: 95% minimum
- (c) Solder: 60/40 Tin-Lead in accordance with QQ-S-571, Type S
- (d) Flux: Type A, in accordance with MIL-F-14256
- (e) Flux immersion time: terminal dipped and allowed to sit 60 seconds
- (f) Solder dwell time: terminal held immediately above solder for 10 seconds then immersed for 3 seconds
- (g) Solder temperature: 232 +_ 5⁰ C
- (h) Number of samples: 20

3.7.9 Resistance to Soldering Heat

3.7.9.1 Wave Soldering - There shall be no evidence of physical damage to the insulator when the unterminated connector or header is subjected to the high temperature extreme imposed during wave soldering. The test shall be in accordance with MIL-STD-202, Method 210; the following details shall apply:

- (a) Test condition: B (10 seconds @ 260 +_ 5⁰ C)
- (b) Immersion depth: To within 0.040 +_ 0.015 of insulator

3.7.9.2 IR Reflow - There shall be no evidence of physical damage to the insulator when the unterminated header or connector is subjected to a maximum of 445⁰ F (230⁰ C) during the solder reflow process.

NUMBER BUS-12-087	TYPE PRODUCT SPECIFICATION		
TITLE Ribcage™ II Printed Wiring Board Connector System		PAGE 14 of 21	REVISION M
		AUTHORIZED BY C. Martinez	DATE 27 Feb 07
CLASSIFICATION UNRESTRICTED			

4.0 PRODUCT QUALIFICATION PROVISIONS

4.1 Equipment Calibration

Any test equipment and inspection facilities used in the performance of any test shall be maintained in a calibration system in accordance with MIL-C-45662.

4.2 Inspection Conditions

Unless otherwise specified herein, all inspections shall be performed under the following ambient conditions:

- (a) Temperature: 25 + _ 5⁰ C
- (b) Relative humidity: 30 to 80%
- (c) Barometric pressure: Local ambient

4.3 Qualification Inspection

Qualification inspection shall be performed on sample units produced with equipment normally used in production.

4.3.1 Sample - Qualification inspection shall be performed on twenty (24) of the largest population connectors of the type for which qualification under this specification is desired.

4.3.2 Preparation of Samples

- 4.3.2.1 Printed Wiring Test Boards - Twelve (12) test boards conforming to the applicable requirements of MIL-P-55110 and MIL-STD-275 shall be prepared as shown in Figure 6 and 7.
- 4.3.2.2 Mating Headers - Twelve (12) mating headers of the appropriate population and configuration and conforming to the requirements of Figure 2 shall be prepared.
- 4.3.2.3 Sample Mounting - Twelve (12) connectors (one per board) shall be installed in, and soldered to, the test boards; a flux more active than that specified in paragraph 3.7.8 (c) may be used to ensure that the solder joint does not contribute any degradation.
- 4.3.2.4 Sample Configuration - The various test samples shall be configured as shown in Table V.

NUMBER BUS-12-087	TYPE PRODUCT SPECIFICATION		
TITLE Ribcage™ II Printed Wiring Board Connector System		PAGE 15 of 21	REVISION M
		AUTHORIZED BY C. Martinez	DATE 27 Feb 07
		CLASSIFICATION UNRESTRICTED	

4.3.3 Test Sequence - The sample connectors shall be subjected to the inspections specified in Table VI in the order shown.

TABLE V - SAMPLE CONFIGURATION

<u>Sample No.</u>	<u>Terminated</u>	<u>Mating Header Required</u>
1-2	No	No
3-6	Yes	Yes
7-8	No	No

4.4 Requalification Testing

If either of the following conditions occur, the product responsible engineer shall initiate requalification testing:

4.4.1 A significant design change is made to an existing product previously qualified under this specification. A significant design change shall be defined to include, but not be limited to, changes in contact material composition, contact material thickness, contact force, contact surface geometry, underlying material composition, underlying material thickness, insulation design, contact base material, or contact lubrication requirements.

Requalification testing shall consist of all or applicable parts of the Qualification Test Matrix as determined by development/product, quality, test, and reliability engineering.

NUMBER BUS-12-087	TYPE PRODUCT SPECIFICATION		
TITLE Ribcage™ II Printed Wiring Board Connector System		PAGE 16 of 21	REVISION M
		AUTHORIZED BY C. Martinez	DATE 27 Feb 07
		CLASSIFICATION UNRESTRICTED	

**FIGURE 6 .050 CENTER THROUGH MOUNT
TEST PCB-TYPE**

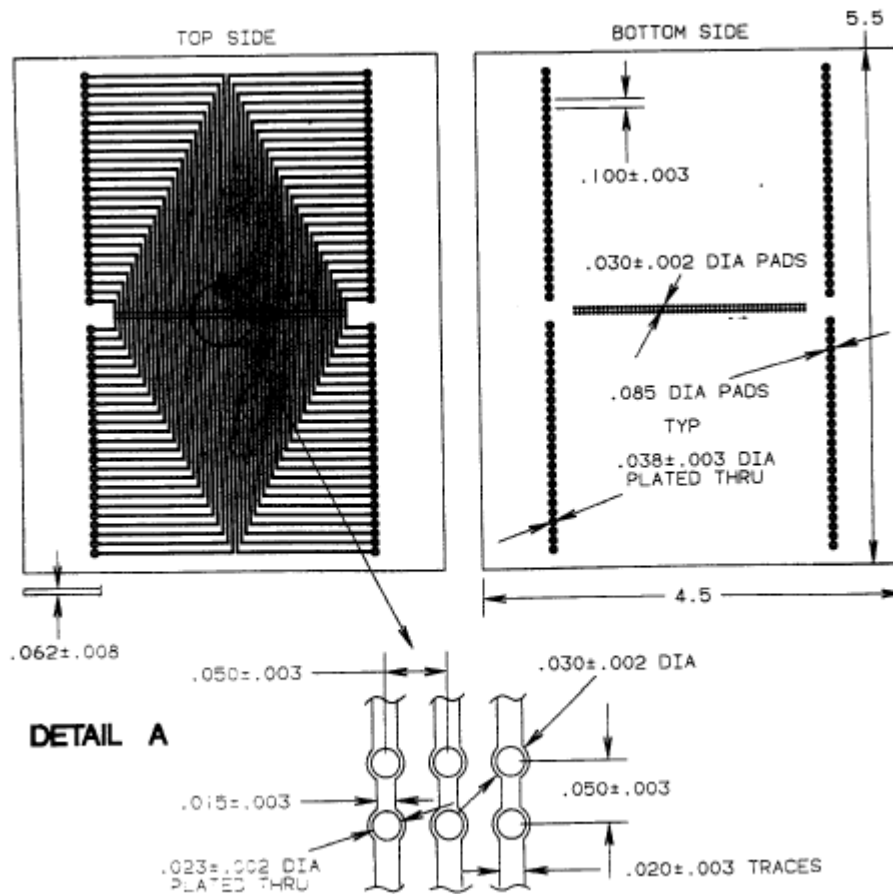

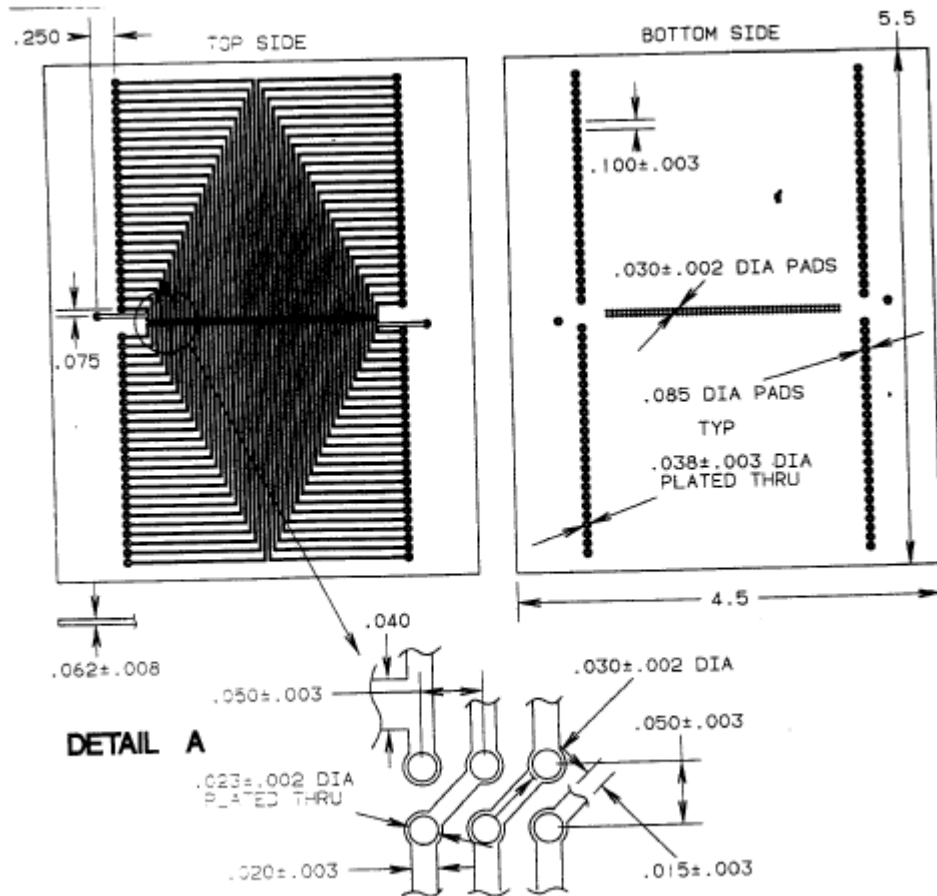

NUMBER BUS-12-087	TYPE PRODUCT SPECIFICATION		
TITLE Ribcage™ II Printed Wiring Board Connector System		PAGE 17 of 21	REVISION M
		AUTHORIZED BY C. Martinez	DATE 27 Feb 07
		CLASSIFICATION UNRESTRICTED	

**FIGURE 7 .050 CENTER THROUGH MOUNT
TEST PCB-TYPE 2**

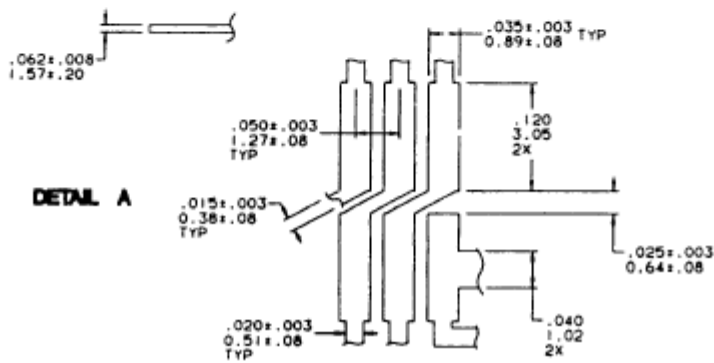
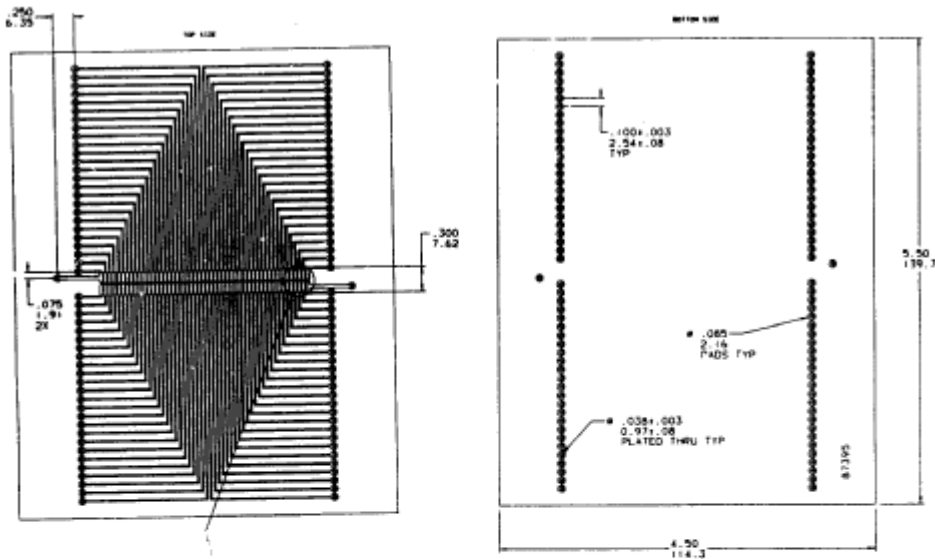

NUMBER BUS-12-087	TYPE PRODUCT SPECIFICATION		
TITLE Ribcage™ II Printed Wiring Board Connector System		PAGE 18 of 21	REVISION M
		AUTHORIZED BY C. Martinez	DATE 27 Feb 07
		CLASSIFICATION UNRESTRICTED	



NUMBER BUS-12-087	TYPE PRODUCT SPECIFICATION		
TITLE Ribcage™ II Printed Wiring Board Connector System		PAGE 19 of 21	REVISION M
		AUTHORIZED BY C. Martinez	DATE 27 Feb 07
		CLASSIFICATION UNRESTRICTED	

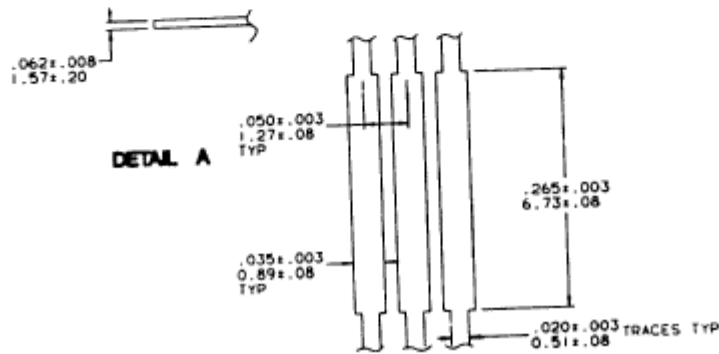
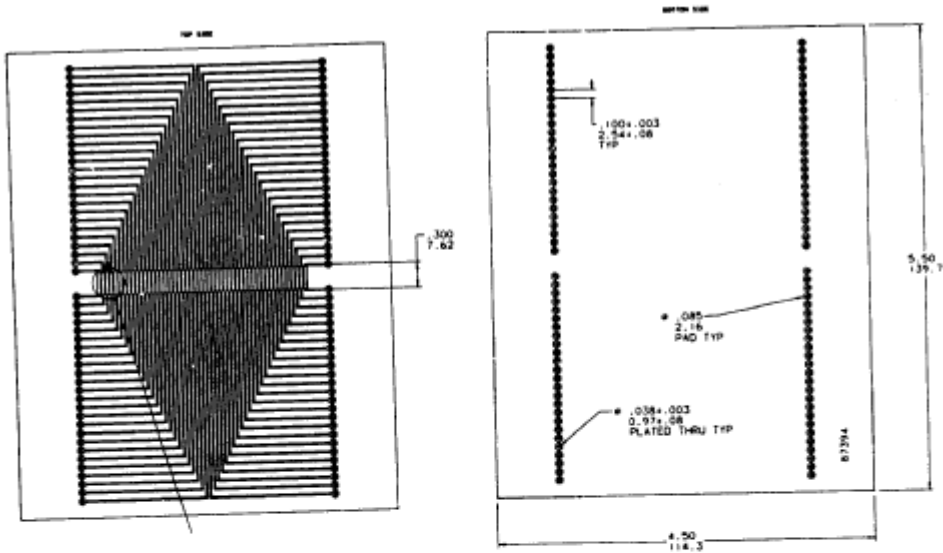



NUMBER BUS-12-087	TYPE PRODUCT SPECIFICATION		
TITLE Ribcage™ II Printed Wiring Board Connector System		PAGE 20 of 21	REVISION M
		AUTHORIZED BY C. Martinez	DATE 27 Feb 07
		CLASSIFICATION UNRESTRICTED	

TABLE VI- DEVELOPMENT AND QUALIFICATION TEST SEQUENCE SELECTION MATRIX

EXAMINATION OR TEST	PARA.	GROUP NO.							
		1	2	3	4	5	6	7	8
EXAMINATION OF PRODUCT	3.4.2	1	1	1	1	1	1	1	1
		10	3	9	14	12	11	3	3
INDIVIDUAL CONTACT WITHDRAWAL FORCE	3.5.3				2	2	2		
TOTAL MATING FORCE	3.5.2				3	3	3		
LOW LEVEL CIRCUIT RESISTANCE	3.5.2			2	4	4	4		
				4	7	7	6		
				6	9	9	8		
				8	11	11	10		
				13					
INSULATION RESISTANCE	3.5.3	2							
		6							
		8							
DIELECTRIC WITHSTANDING VOLTAGE	3.5.4	3							
		9							
CAPACITANCE	3.5.5	4							
CONTACT RETENTION	3.6.1		2						
HUMIDITY	3.7.1	5		3					
THERMAL SHOCK	3.7.2	7		5					
HIGH TEMPERATURE LIFE	3.7.3			7					
SHOCK	3.7.4				5	5			
VIBRATION	3.7.5				6	6			
DURABILITY	3.6.4				8		5		
HYDROGEN SULFIDE	3.7.6				10	8	7		
SALT SPRAY	3.7.7				12	10	9		
SOLDERABILITY	3.7.8							2	
RESISTANCE TO SOLDERING HEAT	3.7.9								2

NUMBER BUS-12-087	TYPE PRODUCT SPECIFICATION		
TITLE Ribcage™ II Printed Wiring Board Connector System		PAGE 21 of 21	REVISION M
		AUTHORIZED BY C. Martinez	DATE 27 Feb 07
		CLASSIFICATION UNRESTRICTED	

REVISION RECORD

<u>REV</u>	<u>PAGE</u>	<u>DESCRIPTION</u>	<u>EC#</u>	<u>DATE</u>
E	3	Change para.3.5.1 to read 1.0 amperes DC for individual. 2.5 amperes DC for the total connector.	V23522	11/02/92
F	3,6 1-20 3,16	Rewrite para. 3.5.1. Change Table 1- B to 100 milliamps DC. Replace "female " and "male" with "receptacle assemblies" and "shrouded headers". Change 100-200 microinches to 200-300. Delete "hand" from 4.3.2.3.	V31580	11/15/93
G	1,2,3,6,11,1 2,14-16,19	2.0 add QQ-N-290 to specifications. Change 3.2.1,3.2.2,3.2.3.,3.3.1,3.3.2. Delete 3.5.2 & renumber. Delete para." When measured in.....". Change 3.7.1,3.7.2,3.7.3 and C. Change 3.7.6& 3.7.7. Delete 3.7.10 and 4.4.2. Update Table VI	V40973	06/10/94
H	9,10	3.6.4 change individual to average. Change Max. dim. From .0185 to .0180.	V41121	07/15/94
J	3,9	3.4.1 & 3.6.2 change 4.0 ounces to 5.5. 3.6.1.2 change average to minimum.	V80317	02/23/98
K	All	Revised format to be consistent with GS-01-001, and change BERG, Dupont, etc. references to FCI.	V01904	08/01/00
L	2,3	3.2, 3.3.3 Changed 200-300 to 100 min.	V11136	06/24/01
M	All 1,2,3	Change FCI Logo. Add "LF" information	M08-0053	06/27/08