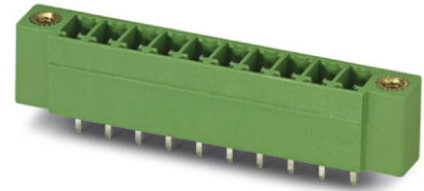

MCV 1,5/ 6-GF-3,81

Order No.: 1830635

The figure shows a 10-position version of the product

<http://eshop.phoenixcontact.net/phoenix/treeViewClick.do?UID=1830635>Header, Nominal current: 8 A, Nom. voltage: 160 V, Pitch: 3.81 mm,
Number of positions: 6, Color: green, Assembly: Soldering

Commercial data

EAN	4017918051280
Pack	50 pcs.
Customs tariff	85366990
Weight/Piece	0.002832 KG
Catalog page information	Page 175 (CC-2009)

Product notes

WEEE/RoHS-compliant since:
01/01/2003

<http://www.download.phoenixcontact.com>
Please note that the data given here has been taken from the online catalog. For comprehensive information and data, please refer to the user documentation. The General Terms and Conditions of Use apply to Internet downloads.

Technical data

Dimensions / positions

Length	7.25 mm
Pitch	3.81 mm
Dimension a	19.05 mm
Number of positions	6
Pin dimensions	0,8 x 0,8 mm

Hole diameter	1.2 mm
Technical data	
Insulating material group	IIIa
Rated surge voltage (III/3)	2.5 kV
Rated surge voltage (III/2)	2.5 kV
Rated surge voltage (II/2)	2.5 kV
Rated voltage (III/2)	160 V
Rated voltage (II/2)	250 V
Connection in acc. with standard	EN-VDE
Nominal current I_N	8 A
Nominal voltage U_N	160 V
Maximum load current	8 A
Insulating material	PBT
Inflammability class acc. to UL 94	V0

Certificates / Approvals



Certification CB, CSA, CUL, GOST, UL, VDE-PZI

CSA

Nominal voltage U_N	300 V
Nominal current I_N	8 A

CUL

Nominal voltage U_N	300 V
Nominal current I_N	8 A

UL

Nominal voltage U_N	300 V
Nominal current I_N	8 A

Accessories

Item	Designation	Description
Marking		
0804109	SK 3,81/2,8:FORTL.ZAHLEN	Marker card, printed horizontally, self-adhesive, 10-section marker strip, 14 identical decades marked 1-10, 11-20 etc. up to 91-(99)100, sufficient for 140 terminal blocks
Plug/Adapter		
1734634	CP-MSTB	Keying profile, is inserted into the slot on the plug or inverted header, red insulating material

Additional products

Item	Designation	Description
General		
1851274	FK-MCP 1,5/ 6-STF-3,81	Plug component, Nominal current: 8 A, Nom. voltage: 160 V, Pitch: 3.81 mm, Number of positions: 6, Connection type: Spring-cage conn., Color: green
1850893	FRONT-MC 1,5/ 6-STF-3,81	Plug component, Nominal current: 8 A, Nom. voltage: 160 V, Pitch: 3.81 mm, Number of positions: 6, Connection type: Screw connection, Color: green
1827745	MC 1,5/ 6-STF-3,81	Plug component, Nominal current: 8 A, Nom. voltage: 160 V, Pitch: 3.81 mm, Number of positions: 6, Connection type: Screw connection, Color: green
1852406	MCC 1/ 6-STZF-3,81	Plug component, Nominal current: 8 A, Nom. voltage: 160 V, Pitch: 3.81 mm, Number of positions: 6, Connection type: Crimp connection, Color: green
1828388	MCVR 1,5/ 6-STF-3,81	Plug component, Nominal current: 8 A, Nom. voltage: 160 V, Pitch: 3.81 mm, Number of positions: 6, Connection type: Screw connection, Color: green
1828537	MCVW 1,5/ 6-STF-3,81	Plug component, Nominal current: 8 A, Nom. voltage: 160 V, Pitch: 3.81 mm, Number of positions: 6, Connection type: Screw connection, Color: green
1897584	QC 0,5/ 6-STF-3,81	Plug component, Nominal current: 6 A, Nom. voltage: 320 V, Pitch: 3.81 mm, Number of positions: 6, Connection type: Insulation displacement connection QUICKON, Color: green

Diagrams/Drawings

Drilling plan/solder pad geometry

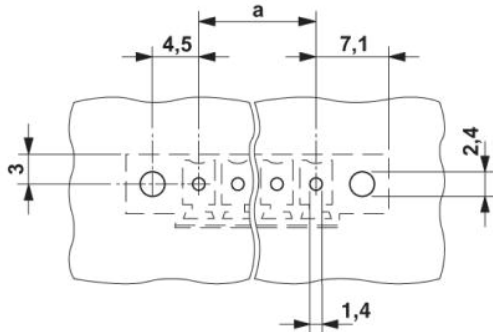

Dimensioned drawing

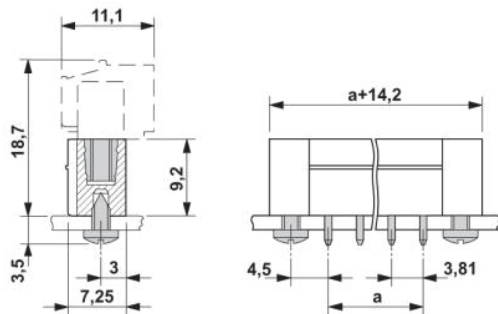

Address

PHOENIX CONTACT GmbH & Co. KG
Flachsmarktstr. 8
32825 Blomberg, Germany
Phone +49 5235 3 00
Fax +49 5235 3 41200
<http://www.phoenixcontact.com>



© 2010 Phoenix Contact
Technical modifications reserved;