

SPTA 1/ 3-3,5

Order No.: 1752117

The illustration shows the 10-position version

<http://eshop.phoenixcontact.net/phoenix/treeViewClick.do?UID=1752117>

PC terminal block, Nominal current: 9 A, Nom. voltage: 160 V, Pitch: 3.5 mm, Number of positions: 3, Type of connection: Spring-cage conn., Assembly: Soldering, Conductor/PCB connection direction: 45 °, Color: green

Commercial data

EAN	4046356320962
Pack	50 pcs.
Customs tariff	85369010
Weight/Piece	0.00181 KG
Catalog page information	Page 105 (CC-2009)

Product notes

WEEE/RoHS-compliant since:
10/02/2007

<http://www.download.phoenixcontact.com>
Please note that the data given here has been taken from the online catalog. For comprehensive information and data, please refer to the user documentation. The General Terms and Conditions of Use apply to Internet downloads.

Technical data

Dimensions / positions

Length	10 mm
Pitch	3.5 mm
Dimension a	7 mm

Number of positions	3
Pin dimensions	0,6 x 1,0 mm
Pin spacing	3.5 mm
Hole diameter	1.1 mm

Technical data

Insulating material group	I
Rated surge voltage (III/3)	2.5 kV
Rated surge voltage (III/2)	2.5 kV
Rated surge voltage (II/2)	2.5 kV
Rated voltage (III/2)	200 V
Rated voltage (II/2)	400 V
Connection in acc. with standard	EN-VDE
Nominal current I_N	9 A
Nominal voltage U_N	160 V
Nominal cross section	1 mm ²
Maximum load current	9 A
Insulating material	PA
Inflammability class acc. to UL 94	V0
Stripping length	8 mm

Connection data

Conductor cross section solid min.	0.2 mm ²
Conductor cross section solid max.	1.5 mm ²
Conductor cross section stranded min.	0.2 mm ²
Conductor cross section stranded max.	1 mm ²
Conductor cross section stranded, with ferrule without plastic sleeve min.	0.25 mm ²
Conductor cross section stranded, with ferrule without plastic sleeve max.	0.75 mm ²
Conductor cross section stranded, with ferrule with plastic sleeve min.	0.25 mm ²
Conductor cross section stranded, with ferrule with plastic sleeve max.	0.75 mm ²
Conductor cross section AWG/kcmil min.	24
Conductor cross section AWG/kcmil max	16

Certificates / Approvals



Certification CUL, UL

CUL

Nominal voltage U_N	300 V
Nominal current I_N	10 A
AWG/kcmil	26-16

UL

Nominal voltage U_N	300 V
Nominal current I_N	10 A
AWG/kcmil	26-16

Diagrams/Drawings

Drilling plan/solder pad geometry

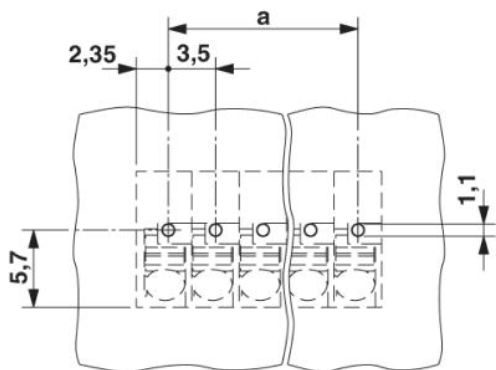

Dimensioned drawing

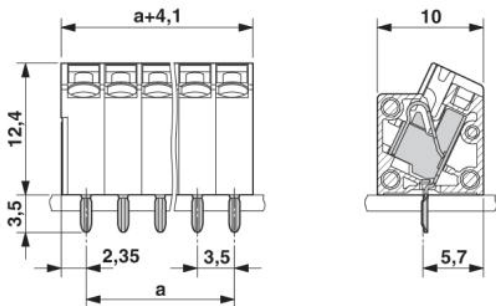

Address

PHOENIX CONTACT GmbH & Co. KG
Flachsmarktstr. 8
32825 Blomberg, Germany
Phone +49 5235 3 00
Fax +49 5235 3 41200
<http://www.phoenixcontact.com>



© 2010 Phoenix Contact
Technical modifications reserved;