

Features

- 2.0mmx1.2mm SMT LED, 1.1mm THICKNESS.
- LOW POWER CONSUMPTION.
- WIDE VIEWING ANGLE.
- IDEAL FOR BACKLIGHT AND INDICATOR.
- VARIOUS COLORS AND LENS TYPES AVAILABLE.

KP-2012PBC BLUE

Package Dimensions

Description

The Blue source color devices are made with InGaN on SiC Light Emitting Diode.

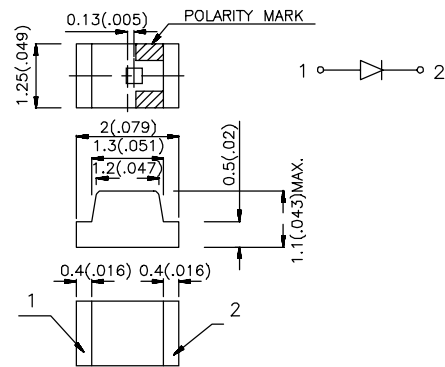

Notes:

1. All dimensions are in millimeters (inches).
2. Tolerance is ± 0.1 (0.004") unless otherwise noted.
3. Lead spacing is measured where the lead emerge package.
4. Specifications are subjected to change without notice.

Selection Guide

Part No.	Dice	Lens Type	Iv (mcd) @ 20 mA		Viewing Angle
			Min.	Typ.	2 θ 1/2
KP-2012PBC	BLUE (InGaN)	WATER CLEAR	30	45	120°

Note:

1. θ 1/2 is the angle from optical centerline where the luminous intensity is 1/2 the optical centerline value.

Electrical / Optical Characteristics at T_A=25°C

Symbol	Parameter	Device	Typ.	Max.	Units	Test Conditions
λ_{peak}	Peak Wavelength	Blue	468		nm	IF=20mA
$\Delta\lambda_{1/2}$	Spectral Line Halfwidth	Blue	26		nm	IF=20mA
C	Capacitance	Blue	110		pF	V _F =0V;f=1MHz
V _F	Forward Voltage	Blue	3.5	4.0	V	IF=20mA
I _R	Reverse Current	All		10	uA	V _R = 5V

Absolute Maximum Ratings at T_A=25°C

Parameter	Blue	Units
Power dissipation	102	mW
DC Forward Current	30	mA
Peak Forward Current [1]	100	mA
Reverse Voltage	5	V
Operation Temperature	-20°C To +80°C	
Storage Temperature	-30°C To +85°C	

Note:

1. 1/10 Duty Cycle, 0.1ms Pulse Width.

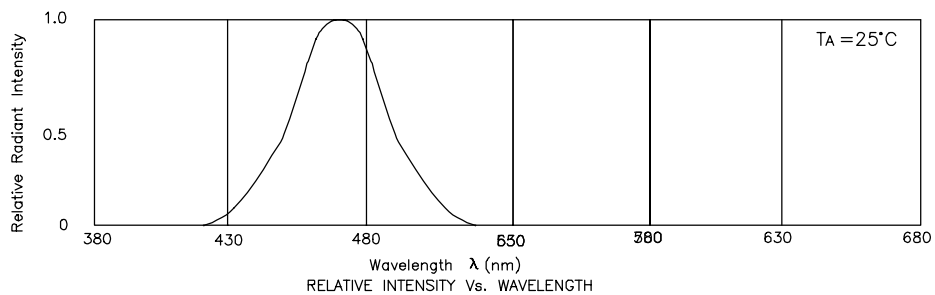

Blue KP-2012PBC

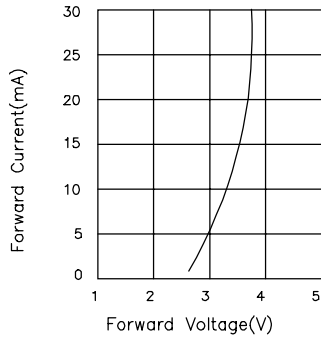

FORWARD CURRENT Vs. FORWARD VOLTAGE

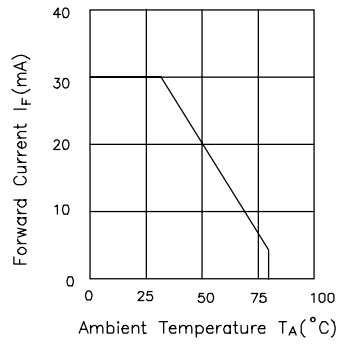

FORWARD CURRENT DERATING CURVE

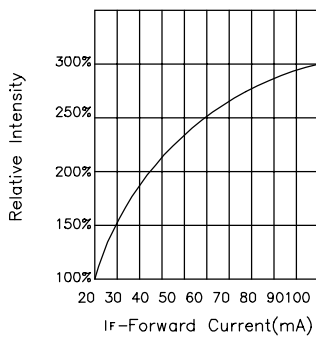

RELATIVE INTENSITY Vs. FORWARD CURRENT

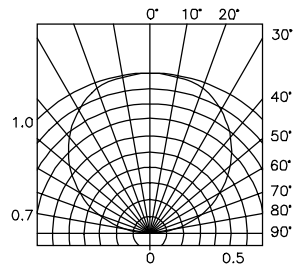

SPATIAL DISTRIBUTION

KP-2012PBC SMT Reflow Soldering Instructions

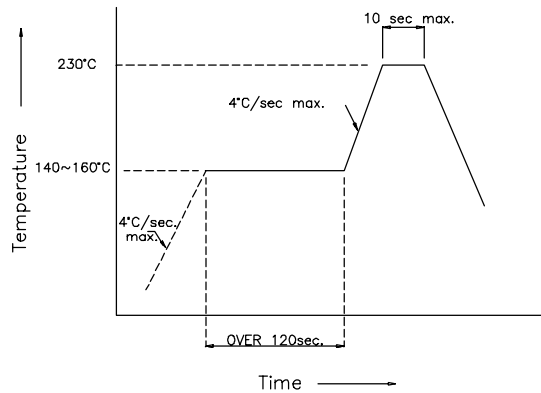

KP-2012PBC Recommended Soldering Pattern (Units : mm)

FOR REFLOW SOLDERING

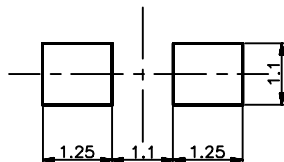

KP-2012PBC Tape Specifications (Units : mm)

