

PRODUCTS

- [Products Home](#)
- [Size Table](#)
- [Accessories](#)
- [Customization](#)
- [A-Series](#)
- [C-Series](#)
- [CA-Series](#)
- [CH-Series](#)
 - [CH-Home](#)
 - [CH-4](#)
 - [CH-6](#)
 - [CH-8](#)
- [G-Series](#)
- [H-Series](#)
- [M-Series](#)
- [R-Series](#)
- [RX-Series](#)
- [S-Series](#)
- [SL-Series](#)

Products: CH-Series



[FEATURES](#)

[COLORS](#)

[MODELS](#)

[ACCESSORIES](#)

FEATURES

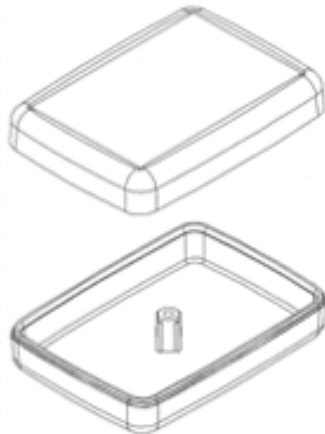

- Two-piece design with rounded edges for smooth feel
- Accepts 0.031" thick circuit board trapped on outer perimeter and central boss
- Single-screw assembly
- Customization available
 - one insert area/l-Plate ([top](#))
 - [machining](#)
 - [pad printing](#)

COLORS



Black











Almond



Gray

[Custom Colors Also Available](#)

MODEL	IMAGE (click photo for full specs)	LENGTH	WIDTH	HEIGHT	DRAWINGS (.pdf) (.dwg)	
CH-4		2.265"	1.515"	0.585"		
CH-6		2.390"	1.740"	0.755"		
CH-8		2.400"	1.850"	0.925"		

[RETURN TO TOP](#)

ACCESSORIES (Click an accessory for compatible models and part numbers)



Key Holder

[RETURN TO TOP](#)



Pocket Clip

[Home](#) | [About SERPAC](#) | [Products](#) | [Accessories](#) | [Customizations](#) | [Distributors](#) | [Buy Now!](#) | [Contact Us](#)
 PRODUCTS: [A-Series](#) | [C-Series](#) | [CA-Series](#) | [CH-Series](#) | [G-Series](#) | [H-Series](#) | [M-Series](#) | [R-Series](#) | [S-Series](#) | [SL-Series](#)

© 2004, SERPAC Electronic Enclosures. All Rights Reserved

