



Title	<i>Reference Design Report for a 35 W Power Supply Using TOP258PN</i>
Specification	90 VAC to 265 VAC Input 5 V, 2.2 A and 12 V, 2 A Output
Application	LCD Monitor
Author	Power Integrations Applications Department
Document Number	RDR-142
Date	September 24, 2007
Revision	1.0

Summary and Features

- Low cost, low component count, high efficiency
 - Delivers 35 W at 50°C ambient without requiring an external heat sink
 - Meets output cross regulation requirements without linear regulators
- EcoSmart® – meets requirements for low no-load and standby power consumption
 - 0.42 W output power for <1 W input
 - No-load power consumption < 300 mW at 230 VAC
 - >82% full load efficiency
- Integrated safety/reliability features:
 - Accurate, auto-recovering, hysteretic thermal shutdown function maintains safe PCB temperatures under all conditions
 - Auto-restart protects against output short circuits and open feedback loops
 - Output OVP protection configurable for latching or self recovering
 - Input UV prevents power up / power down output glitches
- Meets EN55022 and CISPR-22 Class B conducted EMI with > 10 dB μ V margin

The products and applications illustrated herein (including circuits external to the products and transformer construction) may be covered by one or more U.S. and foreign patents or potentially by pending U.S. and foreign patent applications assigned to Power Integrations. A complete list of Power Integrations' patents may be found at www.powerint.com.

Table of Contents

1	Introduction.....	4
2	Power Supply Specification.....	5
3	Schematic.....	6
4	Circuit Description.....	7
4.1	Input EMI Filtering.....	7
4.2	TOPSwitch-HX Primary.....	7
4.3	Output Rectification.....	8
4.4	Output Feedback.....	9
4.5	PCB Layout.....	10
5	Bill of Materials.....	11
6	Transformer Specification.....	13
6.1	Electrical Diagram.....	13
6.2	Electrical Specifications.....	13
6.3	Materials.....	13
6.4	Transformer Build Diagram.....	14
6.5	Transformer Construction.....	15
7	Design Spreadsheet.....	16
8	Performance Data.....	20
8.1	Efficiency.....	20
8.1.1	Active Mode CEC Measurement Data.....	20
8.2	No-load Input Power.....	22
8.3	Available Standby Output Power.....	23
9	Regulation.....	24
9.1.1	Load.....	24
9.1.2	Line.....	25
9.1.3	Cross Regulation Matrix.....	26
10	Thermal Performance.....	27
11	Waveforms.....	28
11.1	Drain Voltage and Current, Normal Operation.....	28
11.2	Output Voltage Start-up Profile.....	28
11.3	Drain Voltage and Current Start-up Profile.....	30
11.4	Load Transient Response (75% to 100% Load Step).....	31
11.5	Output Over-voltage Protection.....	32
11.6	Output Ripple Measurements.....	33
11.6.1	Ripple Measurement Technique.....	33
11.6.2	Measurement Results.....	34
12	Line Surge.....	35
13	Control Loop Measurements.....	36
13.1	90 VAC Maximum Load.....	36
13.2	265 VAC Maximum Load.....	36
14	Conducted EMI.....	37
15	Revision History.....	38

Important Note:



Although this board is designed to satisfy safety isolation requirements, the engineering prototype has not been agency approved. Therefore, all testing should be performed using an isolation transformer to provide the AC input to the prototype board.



1 Introduction

This document is an engineering report describing a LCD Monitor power supply utilizing a TOP258PN. This power supply is intended as a general purpose evaluation platform for TOPSwitch-HX.

The document contains the power supply specification, schematic, bill of materials, transformer documentation, printed circuit layout, and performance data.

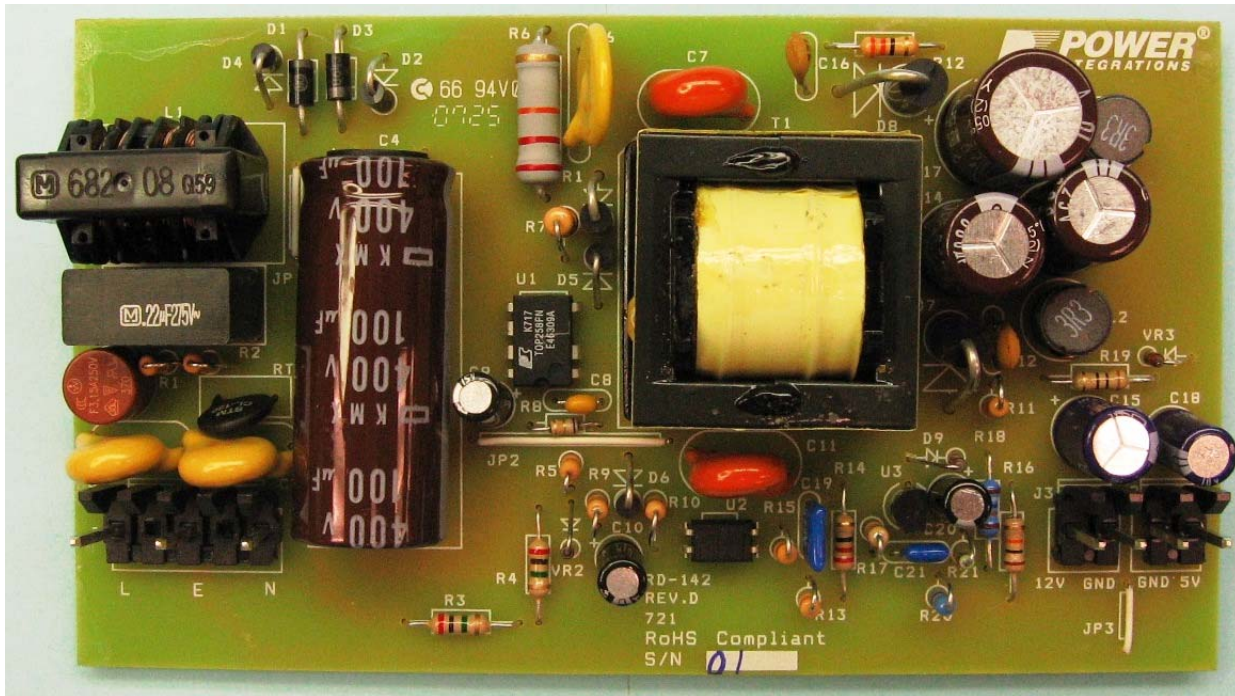

Figure 1 – Populated Circuit Board Photograph (5”L x 2.84”W x 1.16”H)



2 Power Supply Specification

Description	Symbol	Min	Typ	Max	Units	Comment
Input						
Voltage	V_{IN}	90		265	VAC	3 wire input
Frequency	f_{LINE}	47	50/60	64	Hz	
No-load Input Power (230 VAC)				0.3	W	
Output						
Output Voltage 1	V_{OUT1}	4.75	5	5.25	V	± 5% 20 MHz bandwidth
Output Ripple Voltage 1	$V_{RIPPLE1}$			100	mV	
Output Current 1	I_{OUT1}	0		2.2	A	± 20% 20 MHz bandwidth
Output Voltage 2	V_{OUT2}	9.6	12	14.4	V	
Output Ripple Voltage 2	$V_{RIPPLE2}$			500	mV	
Output Current 2	I_{OUT2}	0		2	A	
Total Output Power						
Continuous Output Power	P_{OUT}		35		W	
Efficiency						
Full Load	η	82			%	Measured at P_{OUT} 25 °C 5 V @ 82 mA, 12 V @ 0 mA; Vin at 264 VAC
Standby Input Power				1	W	
Required average efficiency at 25, 50, 75 and 100 % of P_{OUT}	η_{CEC}^*	81			%	Per California Energy Commission (CEC) / Energy Star requirements
Environmental						
Conducted EMI			Meets CISPR22B / EN55022B			1.2/50 μ s surge, IEC 1000-4-5, Series Impedance: Differential Mode: 2 Ω Common Mode: 12 Ω
Safety			Designed to meet IEC950, UL1950 Class II			
Surge						
Differential Common Mode		1 2			kV kV	
Surge Ring Wave		1			kV	100 kHz ring wave, 500 A short circuit current, differential and common mode
Ambient Temperature	T_{AMB}	0		50	°C	Free convection, sea level

*Shown for information only as CEC requirement does not apply to internal power supplies



3 Schematic

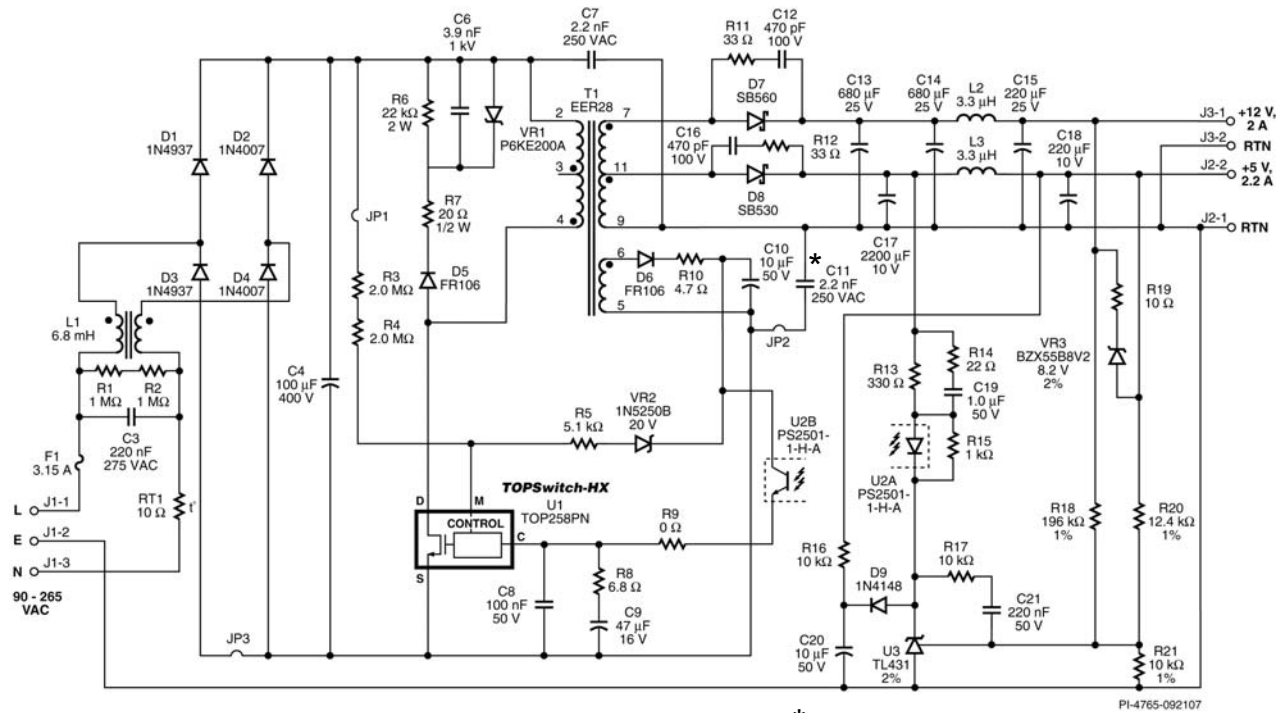

*Optional for 2 wire input, floating output

Figure 2 – Schematic.



4 Circuit Description

A Flyback converter configuration built around TOP258PN is used in this power supply to obtain two output voltages. The 5 V output can supply a load current of 2.2 A, and the 12 V output can supply a load current of 2.0 A. This power supply can operate between 90 – 264 VAC. The 5 V output is the main regulated output. This output is regulated using a TL431 voltage reference. Some feedback is also derived from the 12 V output for improved cross regulation.

4.1 Input EMI Filtering

The three wire AC supply is connected to the circuit using connector J1. Fuse F1 provides protection against circuit faults and effectively isolates the circuit from the AC supply source. Thermistor RT1 limits the inrush current drawn by the circuit at start up. Optional capacitors C1 and C2 are Y capacitors connected from the Line/Neutral to Earth to reduce common mode EMI.

Capacitor C3 is the X capacitor and helps to reduce the differential mode EMI. Resistors R1 and R2 discharge C3 on AC removal, preventing potential user shock. Inductor L1 is a common-mode inductor and helps in filtering common-mode EMI from coupling back to the AC source.

Diodes D1, D2, D3 and D4 form a bridge rectifier. The bridge rectifier rectifies the incoming AC supply to DC, which is filtered by capacitor C4.

Diodes D1 and D3 are fast recovery type diodes. These diodes recover very quickly when the voltage across them reverses. This reduces excitation of stray line inductance in the AC input by reducing the subsequent high frequency turnoff snap and hence EMI. Only 2 of the 4 diodes in the bridge need to be fast recovery type, since 2 diodes conduct in each half cycle.

4.2 TOPSwitch-HX Primary

Resistor R3 and R4 provide line voltage sensing and provide a current to U1, which is proportional to the DC voltage across capacitor C4. At approximately 95 V DC, the current through these resistors exceeds the line under-voltage threshold of 25 μ A, which results in enabling of U1.

The TOPSwitch-HX regulates the output using PWM-based voltage mode control. At high loads the controller operates at full switching frequency (66 kHz for P package devices). The duty cycle is controlled based on the control pin current to regulate the output voltage.

The internal current limit provides cycle-by-cycle peak current limit protection. The TOPSwitch-HX controller has a second current limit comparator allowing monitoring the actual peak drain current (I_P) relative to the programmed current limit $I_{LIMITEXT}$. As soon



as the ratio $I_P/I_{LIMITEXT}$ falls below 55%, the peak drain current is held constant. The output is then regulated by modulating the switching frequency (variable frequency PWM control). As the load decreases further, the switching frequency decreases linearly from full frequency down to 30 kHz.

Once the switching frequency has reached 30 kHz the controller keeps this switching frequency constant and the peak current is reduced to regulate the output (fixed frequency, direct duty cycle PWM control).

As the load is further reduced and the ratio $I_P/I_{LIMITEXT}$ falls below 25%, the controller will enter a multi-cycle-modulation mode for excellent efficiency at light load or standby operation and low no-load input power consumption.

Diode D5, together with R6, R7, C6 and Zener VR1, forms a clamp network that limits the drain voltage of U1 at the instant of turn-off. Zener VR1 provides a defined maximum clamp voltage and typically only conducts during fault conditions such as overload. This allows the RCD clamp (R6, C6 and D5) to be sized for normal operation, thereby maximizing efficiency at light load. Resistor R7 is required due to the choice of a fast recovery diode for D5. A fast versus ultra fast recovery diode allows some recovery of the clamp energy but requires R7 to limit reverse diode current and dampen high frequency ringing.

The output of the bias winding is rectified by diode D6 and filtered by resistor R10 and capacitor C10. This rectified and filtered output is used by the optocoupler U2 to provide the control current to the control terminal of U1.

Should the feedback circuit fail (open loop condition), the output of the power supply will exceed the regulation limits. This increased voltage at output will also result in an increased voltage at the output of the bias winding. Zener VR2 will break down and current will flow into the "M" pin of IC U1, thus initiating a hysteretic OVP shutdown with automatic restart attempts. Resistor R5 limits the current into the M pin; if latching OVP is desired, the value of R5 can be reduced to 20 Ω .

The output voltage of the power supply is maintained in regulation by the feedback circuit on the secondary side of the circuit. The feedback circuit controls the output voltage by changing the optocoupler current. Change in the optocoupler diode current results in a change of current into the control pin of IC U1. Variation of this current results in variation of duty cycle and hence the output voltage of the power supply.

4.3 Output Rectification

Output rectification for the 5 V output is provided by diode D8. Low ESR capacitor C17 provides filtering. Inductor L3 and capacitor C18 form a second stage filter that significantly attenuates the switching ripple across C17 and ensures a low ripple output.



Output rectification for the 12 V output is provided by diode D7. Low ESR capacitors C13 and C14 provide filtering. Inductor L2 and capacitor C15 form a second stage filter that significantly attenuates the switching ripple and ensures low ripple at the output.

Snubber networks comprising R11, C12 and R12, and C16 damp high frequency ringing across diodes D7 and D8, which results from leakage inductance of the transformer windings and the secondary trace inductances.

4.4 Output Feedback

Output voltage is controlled using the shunt regulator TL431 (U3). Diode D9, capacitor C20 and resistor R16 form the soft finish circuit. At start-up, capacitor C20 is discharged. As the output voltage starts rising, current flows into the optocoupler diode (U2A) via resistor R13 and diode D9. This provides feedback to the circuit on the primary side. The current in the optocoupler diode U2A gradually decreases as capacitor C20 charges and U3 becomes operational. This ensures that the output voltage increases gradually and settles to the final value without any overshoot. Resistor R16 provides a discharge path for C20 into the load at power down. Diode D9 isolates C20 from the feedback circuit after startup.

Resistor R18, R20 and R21 form a voltage divider network that senses the output voltage from both the outputs for better cross-regulation. Resistor R19 and Zener VR3 improve cross regulation when only the 5 V output is loaded, which results in the 12 V output operating at the higher end of the specification.

Resistors R13, R17 and capacitor C21 set the frequency response of the feedback circuit. Capacitor C19 and resistor R14 form the phase boost network that provides adequate phase margin to ensure stable operation over the entire operating voltage range.

Resistor R15 provides the bias current required by the IC U3 and is placed in parallel with U2A to ensure that the bias current to the IC does not become a part of the feedback current. Resistor R13 sets the overall DC loop gain and limits the current through U2A during transient conditions.



4.5 PCB Layout

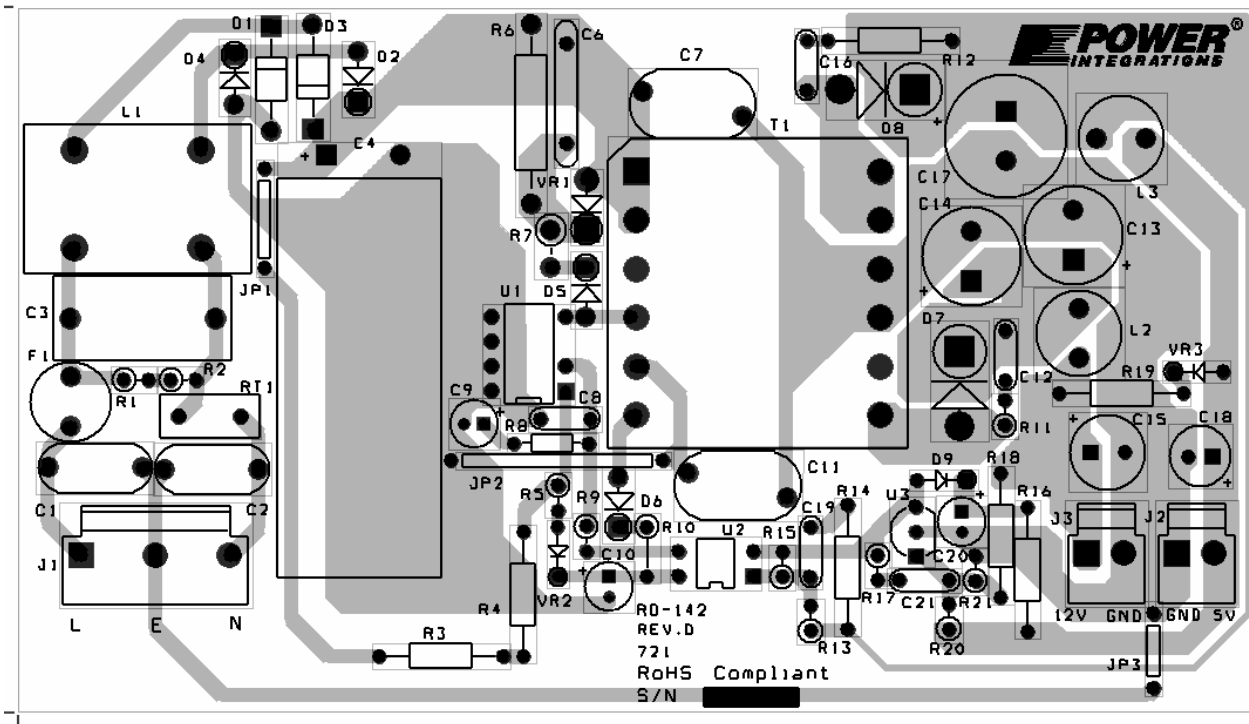

Figure 3 – Printed Circuit Layout.



5 Bill of Materials

Item	Qty	Ref Des	Description	Mfg	Mfg Part Number
		C1			
1	2	C2	1 nF, Ceramic, Y1	Panasonic	ECK-ANA102MB
2	1	C3	220 nF, 275 VAC, Film, X2	Panasonic	ECQ-U2A224ML
3	1	C4	100 uF, 400 V, Electrolytic, Low ESR,	Nippon Chemi- Con	EKMX401ELL101ML40 S
4	1	C6	630 mOhm, (16 x 40)	Panasonic	ECK-A3A392KBP
		C7			
5	2	C11	2.2 nF, Ceramic, Y1	Vishay	440LD22-R
6	1	C8	100 nF, 50 V, Ceramic, Z5U	Kemet	C317C104M5U5TA
7	1	C9	47 uF, 16 V, Electrolytic, Gen Purpose, (5 x 11.5)	Panasonic	ECA-1CHG470
8	2	C10	10 uF, 50 V, Electrolytic, Gen Purpose, (5 x 11)	Panasonic	ECA-1HHG100
		C12			
9	2	C16	470 pF, 100 V, Ceramic, COG	AVX Corp	5NK471KOBAM
10	2	C13	680 uF, 25 V, Electrolytic, Very Low ESR, 23 mOhm, (10 x 20)	Nippon Chemi- Con	EKZE250ELL681MJ20S
11	1	C14	220 uF, 25 V, Electrolytic, Low ESR, 120 mOhm, (8 x 12)	Nippon Chemi- Con	ELXZ250ELL221MH12D
12	1	C15	2200 uF, 10 V, Electrolytic, Very Low ESR, 21 mOhm, (12.5 x 20)	Nippon Chemi- Con	EKZE100ELL222MK20S
13	1	C17	220 uF, 10 V, Electrolytic, Low ESR, 250 mOhm, (6.3 x 11.5)	Nippon Chemi- Con	ELXZ100ELL221MFB5D
14	1	C18	1.0 uF, 50 V, Ceramic, X7R	Epcos	B37984M5105K000
15	1	C19	220 nF, 50 V, Ceramic, X7R	Epcos	B37987F5224K000
16	2	C21	600 V, 1 A, Fast Recovery Diode, 200 ns, DO-41	On Semiconductor	1N4937RLG
		D1			
17	2	D2	1000 V, 1 A, Rectifier, DO-41	Vishay	1N4007
		D3			
18	2	D4	800 V, 1 A, Fast Recovery Diode, 500 ns, DO-41	Diodes Inc.	FR106
19	1	D5	60 V, 5 A, Schottky, DO-201AD	Vishay	SB560
20	1	D6	30 V, 5 A, Schottky, DO-201AD	Fairchild	SB530
21	1	D7	75 V, 300 mA, Fast Switching, DO-35	Vishay	1N4148
22	1	D8	3.15 A, 250V, Fast, TR5	Wickman	37013150410
23	1	D9	5 Position (1 x 5) header, 0.156 pitch	Molex	26-48-1055
24	2	D10	2 Position (1 x 2) header, 0.156 pitch	Molex	26-48-1025
		D11	Wire Jumper, Non insulated,		
25	1	D12	22 AWG, 0.4 in	Alpha	298
		D13	Wire Jumper, Non insulated,		
26	1	D14	22 AWG, 0.8 in	Alpha	298
		D15	Wire Jumper, Non insulated,		
27	1	D16	22 AWG, 0.3 in	Alpha	298
28	1	D17	6.8 mH, 0.8 A, Common Mode Choke	Panasonic	ELF15N008
29	2	D18	3.3 uH, 5.0 A	Coilcraft	RFB0807-3R3L
		D19			
30	2	D20	1 M, 5%, 1/4 W, Carbon Film	Yageo	CFR-25JB-1M0
		D21			
31	2	D22	2.0 M, 5%, 1/4 W, Carbon Film	Yageo	CFR-25JB-2M0



32	1	R5	5.1 k, 5%, 1/4 W, Carbon Film	Yageo	CFR-25JB-5K1
33	1	R6	22 k, 5%, 2 W, Metal Oxide	Yageo	RSF200JB-22K
34	1	R7	20 R, 5%, 1/2 W, Carbon Film	Yageo	CFR-50JB-20R
35	1	R8	6.8 R, 5%, 1/8 W, Carbon Film	Yageo	CFR-12JB-6R8
36	1	R9	100 R, 5%, 1/4 W, Carbon Film	Yageo	CFR-25JB-100R
37	1	R10	4.7 R, 5%, 1/4 W, Carbon Film	Yageo	CFR-25JB-4R7
		R11			
38	2	R12	33 R, 5%, 1/4 W, Carbon Film	Yageo	CFR-25JB-33R
39	1	R13	330 R, 5%, 1/4 W, Carbon Film	Yageo	CFR-25JB-330R
40	1	R14	22 R, 5%, 1/4 W, Carbon Film	Yageo	CFR-25JB-22R
41	1	R15	1 k, 5%, 1/4 W, Carbon Film	Yageo	CFR-25JB-1K0
		R16			
42	2	R17	10 k, 5%, 1/4 W, Carbon Film	Yageo	CFR-25JB-10K
43	1	R18	196 k, 1%, 1/4 W, Metal Film	Yageo	MFR-25FBB-196K
44	1	R19	10 R, 5%, 1/4 W, Carbon Film	Yageo	CFR-25JB-10R
45	1	R20	12.4 k, 1%, 1/4 W, Metal Film	Yageo	MFR-25FBB-12K4
46	1	R21	10 k, 1%, 1/4 W, Metal Film	Panasonic	ERO-S2PHF1002
47	1	RT1	NTC Thermistor, 10 Ohms, 1.7 A	Thermometrics	CL-120
			Core	TDK	PC40EER28-Z
			Bobbin: EER28, Horiz., 12 pins (6/6),	Ying-Chin	YC-2806-5
			Complete Assembly (custom)	Ice Components	TOP07074
				Magtel	32/07 TR.RDK-142
48	1	T1		Precision Inc.	019-4967-00R
				Power	
49	1	U1	TOPSwitch-HX, TOP258PN, DIP-8B	Integrations	TOP258PN
			Opto coupler, 80 V, CTR 80-160%, 4-		
50	1	U2	DIP	NEC	PS2501-1-H-A
			2.495 V Shunt Regulator IC, 2%, 0 to	On	
51	1	U3	70C, TO-92	Semiconductor	TL431CLPG
			200 V, 600 W, 5%, TVS, DO204AC		
52	1	VR1	(DO-15)	OnSemi	P6KE200ARLG
53	1	VR2	20 V, 5%, 500 mW, DO-35	Microsemi	1N5250B
54	1	VR3	8.2 V, 500 mW, 2%, DO-35	Vishay	BZX55B8V2

Note – Parts listed above are RoHS compliant



6 Transformer Specification

6.1 Electrical Diagram

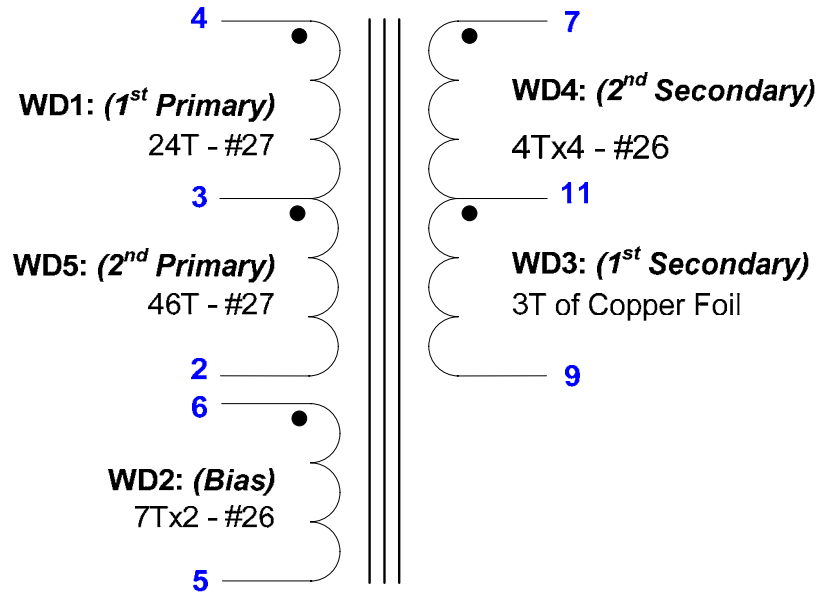

Figure 4 – Transformer Electrical Diagram.

6.2 Electrical Specifications

Electrical Strength	1 second, 60 Hz, from Pins 2,3,4,5,6 to Pins 7,9,11	3000 VAC
Primary Inductance	Pins 2-4, all other windings open, measured at 100 kHz, 0.4 VRMS	1040 μ H, \pm 10%
Resonant Frequency	Pins 2-4, all other windings open	1000 kHz (Min.)
Primary Leakage Inductance	Pins 2-4, with Pins 7-9 shorted, measured at 100 kHz, 0.4 VRMS	20 μ H (Max.)

6.3 Materials

Item	Description
[1]	Core: EER28 gapped for ALG of 213 nH/T ²
[2]	Bobbin: EER28, Horizontal 12 pins (6/6), YC-2806-5
[3]	Magnet Wire: #27 AWG, double coated.
[4]	Magnet Wire: #26 AWG, double coated.
[5]	Tape: 3M Polyester Film, 2.0 mils thick, 16.0 mm wide.
[6]	Tape: 3M Polyester Film, 2.0 mils thick, 10.0 mm wide.
[7]	Copper Foil, 2 mils thick, 142mm long, 8.5mm wide. To be wrapped over with tape item [6].
[8]	Tape: 3M Polyester Film, 2.0 mils thick, 13.5 mm wide.
[9]	Bare Wire: #22 AWG
[10]	Tape: 3M Polyester Film, 2.0 mils thick, 8.0 mm wide.
[11]	Varnish.

6.4 Transformer Build Diagram

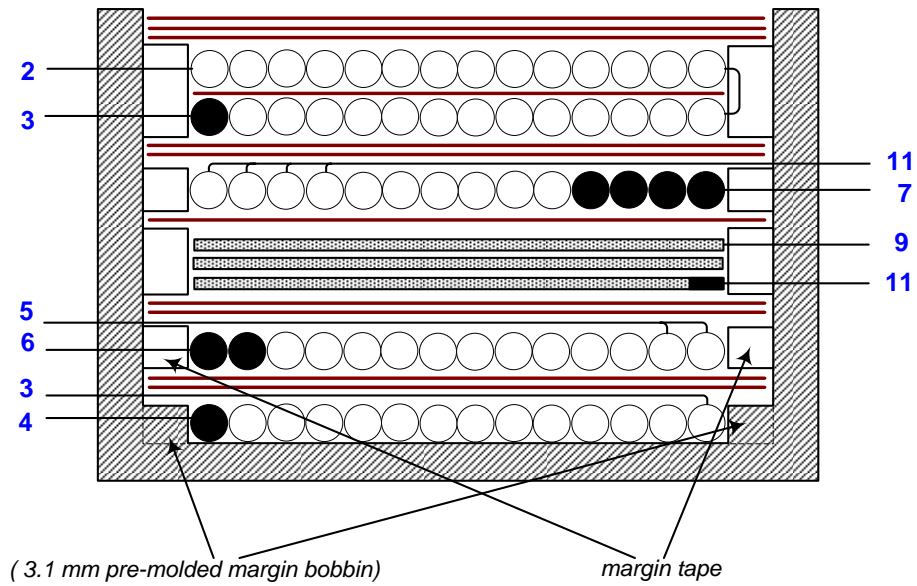

Bobbin: EER28 (Horizontal, 12pins, 6/6), YC-2806-5)

Lp(2-4): 1.04mH +/- 5%

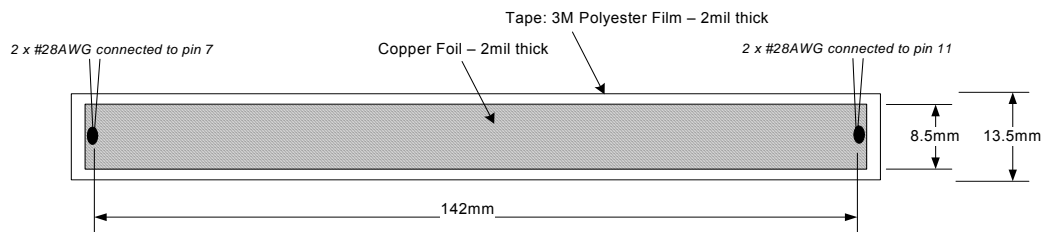

Figure 5 – Transformer Build Diagram.



6.5 Transformer Construction

General Note	Primary side of the bobbin orients to the left hand side. Place 3.1 mm margin tape on both sides for all windings except WD1 due to built-in 3.1 mm margin of bobbin. Winding direction is clockwise.
WD1 1/2 Primary	Start on pin 4, wind 24 turns of item [3] from left to right with tight tension and bring the wire across the bobbin to terminate at pin 3.
Insulation	2 layers of tape item [5].
WD2 Bias	Start on pin 6, wind 7 turns bifilar of item [4] from left to right, spread the winding evenly, and bring the wire across the bobbin to terminate on pin 5.
Insulation	2 layers of tape item [5].
WD3 1st Secondary	Start on pin 11, wind 3 turns of item [7] and terminate at pin 9.
Insulation	1 layer of tape item [5].
WD4 2nd Secondary	Start on pin 7, wind 4 turns quadfilair of item [4] from right to left, spread the winding evenly across the bobbin, and bring the wire back to the right to terminate on pin 11.
Insulation	2 layers of tape item [5].
WD5 2/2 Primary	Start on pin 3, wind 23 turns of item [3] from left to right with tight tension, place 1 layer tape item [6], then wind another 23 turns of item [3] from right to left, also with tight tension, and terminate at pin 2.
Insulation	3 layers of tape item [5].
Assembly	Grind the cores to get 1038 μH with ALG of 213 nH/T^2
Finish	Secure the cores by wrapping around 2 halves of cores with item [10]. Dip varnish uniformly in item [11].



7 Design Spreadsheet

ACDC_TOPSwitchHX_09 0607; Rev.1.2; Copyright Power Integrations 2007	INPUT	INFO	OUTPUT	UNIT	TOPSwitch_HX_090607: TOPSwitch-HX Continuous/Discontinuous Flyback Transformer Design Spreadsheet
ENTER APPLICATION VARIABLES					
VACMIN	90			Volts	Minimum AC Input Voltage
VACMAX	265			Volts	Maximum AC Input Voltage
fL	50			Hertz	AC Mains Frequency
VO	5.00			Volts	Output Voltage (main)
PO_AVG	35.00			Watts	Average Output Power
PO_PEAK			35.00	Watts	Peak Output Power
n	0.80			%/100	Efficiency Estimate
Z	0.50				Loss Allocation Factor
VB	12	Info		Volts	Ensure proper operation at no load.
tC	3.00			mSeco nds	Bridge Rectifier Conduction Time Estimate
CIN	100.0		100	uFara ds	Input Filter Capacitor

ENTER TOPSWITCH-HX VARIABLES					
TOPSwitch-HX	TOP258PN			Univer sal / Peak	115 Doubled/230V
Chosen Device		TOP258PN	Power Out	35 W / 50 W	48W
KI	1.00				External Ilimit reduction factor (KI=1.0 for default ILIMIT, KI <1.0 for lower ILIMIT)
ILIMITMIN_EXT			1.534	Amps	Use 1% resistor in setting external ILIMIT
ILIMITMAX_EXT			1.766	Amps	Use 1% resistor in setting external ILIMIT
Frequency (F)=132kHz, (H)=66kHz			H		Only half frequency option available for P, G and M package devices. For full frequency operation choose Y package.
fS			66000	Hertz	TOPSwitch-HX Switching Frequency: Choose between 132 kHz and 66 kHz
fSmin			59400	Hertz	TOPSwitch-HX Minimum Switching Frequency
fSmax			72600	Hertz	TOPSwitch-HX Maximum Switching Frequency
High Line Operating Mode			FF		
VOR	128.00			Volts	Reflected Output Voltage
VDS	5.63		5.63	Volts	TOPSwitch on-state Drain to Source Voltage
VD	0.50			Volts	Output Winding Diode Forward Voltage Drop
VDB	0.70			Volts	Bias Winding Diode Forward Voltage Drop
KP	0.69				Ripple to Peak Current Ratio (0.3 < KRP < 1.0 : 1.0 < KDP < 6.0)



PROTECTION FEATURES					
LINE SENSING					
VUV_STARTUP	95.00	95	Volts		Note - For P/G package devices only one of either Line sensing or Overload power limiting protection features can be used. For all other packages both these functions can be simultaneously used.
VOV_SHUTDOWN		445	Volts		DC Bus Voltage at which the power supply will start-up
RLS		4.0	M-ohms		DC Bus Voltage at which power supply will shut-down
OUTPUT OVERVOLTAGE					
VZ		22	Volts		Use two standard, 2 M-Ohm, 5% resistors in series for line sense functionality.
RZ		5.1	k-ohms		Zener Diode rated voltage for Output Overvoltage shutdown protection
OVERLOAD POWER LIMITING					
Overload Current Ratio at VMAX		1.2			Output OVP resistor. For latching shutdown use 20 ohm resistor instead
Overload Current Ratio at VMIN		1.25			Enter the desired margin to current limit at VMAX. A value of 1.2 indicates that the current limit should be 20% higher than peak primary current at VMAX
ILIMIT_EXT_VMIN		1.23	A		Margin to current limit at low line.
ILIMIT_EXT_VMAX		1.14	A		External Current limit at VMIN
RIL		8.29	k-ohms		External Current limit at VMAX
RPL		29.27	M-ohms		Current limit/Power Limiting resistor.
			ohms		Power Limiting resistor

ENTER TRANSFORMER CORE/CONSTRUCTION VARIABLES					
Core Type	EER28	EER28			Core Type
Core		EER28	P/N:		PC40EER28-Z
Bobbin		EER28_BO	P/N:		
		BBIN			
AE		0.821	cm^2		Core Effective Cross Sectional Area
LE		6.4	cm		Core Effective Path Length
AL		2870	nH/T^2		Ungapped Core Effective Inductance
BW		16.7	mm		Bobbin Physical Winding Width
M	3.00		mm		Safety Margin Width (Half the Primary to Secondary Creepage Distance)
L	3.00				Number of Primary Layers
NS	3	3			Number of Secondary Turns

DC INPUT VOLTAGE PARAMETERS					
VMIN		100	Volts		Minimum DC Input Voltage
VMAX		375	Volts		Maximum DC Input Voltage

CURRENT WAVEFORM SHAPE PARAMETERS					
DMAX		0.57			Maximum Duty Cycle (calculated at PO_PEAK)
I AVG		0.44	Amps		Average Primary Current (calculated at average output power)
IP		1.16	Amps		Peak Primary Current (calculated at Peak output power)
IR		0.80	Amps		Primary Ripple Current (calculated at average output power)
IRMS		0.60	Amps		Primary RMS Current (calculated at average output power)



TRANSFORMER PRIMARY DESIGN PARAMETERS

LP		1040	uHenries	Primary Inductance
LP Tolerance		10		Tolerance of Primary Inductance
NP		70		Primary Winding Number of Turns
NB		7		Bias Winding Number of Turns
ALG		213	nH/T^2	Gapped Core Effective Inductance
BM		2101	Gauss	Maximum Flux Density at PO, VMIN (BM<3000)
BP		3524	Gauss	Peak Flux Density (BP<4200) at ILIMITMAX and LP_MAX. Note: Recommended values for adapters and external power supplies <=3600 Gauss
BAC		725	Gauss	AC Flux Density for Core Loss Curves (0.5 X Peak to Peak)
ur		1780		Relative Permeability of Ungapped Core
LG		0.45	mm	Gap Length (Lg > 0.1 mm)
BWE		32.1	mm	Effective Bobbin Width
OD		0.46	mm	Maximum Primary Wire Diameter including insulation
INS		0.06	mm	Estimated Total Insulation Thickness (= 2 * film thickness)
DIA		0.40	mm	Bare conductor diameter
AWG		27	AWG	Primary Wire Gauge (Rounded to next smaller standard AWG value)
CM		203	Cmils	Bare conductor effective area in circular mils
CMA		338	Cmils/A mp	Primary Winding Current Capacity (200 < CMA < 500)
Primary Current Density (J)		5.88	Amps/m m^2	Primary Winding Current density (3.8 < J < 9.75)

TRANSFORMER SECONDARY DESIGN PARAMETERS (SINGLE OUTPUT EQUIVALENT)**Lumped parameters**

ISP		26.95	Amps	Peak Secondary Current
ISRMS		12.03	Amps	Secondary RMS Current
IO_PEAK		7.00	Amps	Secondary Peak Output Current
IO		7.00	Amps	Average Power Supply Output Current
IRIPPLE		9.79	Amps	Output Capacitor RMS Ripple Current
CMS		2407	Cmils	Secondary Bare Conductor minimum circular mils
AWGS		16	AWG	Secondary Wire Gauge (Rounded up to next larger standard AWG value)
DIAS		1.29	mm	Secondary Minimum Bare Conductor Diameter
ODS		3.57	mm	Secondary Maximum Outside Diameter for Triple Insulated Wire
INSS		1.14	mm	Maximum Secondary Insulation Wall Thickness

VOLTAGE STRESS PARAMETERS

VDRAIN		625	Volts	Maximum Drain Voltage Estimate (Includes Effect of Leakage Inductance)
PIVS		21	Volts	Output Rectifier Maximum Peak Inverse Voltage
PIVB		49	Volts	Bias Rectifier Maximum Peak Inverse Voltage



TRANSFORMER SECONDARY DESIGN PARAMETERS (MULTIPLE OUTPUTS)**1st output**

VO1	5.00	5	Volts	Output Voltage
IO1_AVG	2.20	2.2	Amps	Average DC Output Current
PO1_AVG		11.00	Watts	Average Output Power
VD1		0.5	Volts	Output Diode Forward Voltage Drop
NS1		3.00		Output Winding Number of Turns
ISRMS1		3.782	Amps	Output Winding RMS Current
IRIPPLE1		3.08	Amps	Output Capacitor RMS Ripple Current
PIVS1		21	Volts	Output Rectifier Maximum Peak Inverse Voltage
CMS1		756	Cmils	Output Winding Bare Conductor minimum circular mils
AWGS1		21	AWG	Wire Gauge (Rounded up to next larger standard AWG value)
DIAS1		0.73	mm	Minimum Bare Conductor Diameter
ODS1		3.57	mm	Maximum Outside Diameter for Triple Insulated Wire

2nd output

VO2	12.00		Volts	Output Voltage
IO2_AVG	2.00		Amps	Average DC Output Current
PO2_AVG		24.00	Watts	Average Output Power
VD2		0.7	Volts	Output Diode Forward Voltage Drop
NS2		6.93		Output Winding Number of Turns
ISRMS2		3.438	Amps	Output Winding RMS Current
IRIPPLE2		2.80	Amps	Output Capacitor RMS Ripple Current
PIVS2		49	Volts	Output Rectifier Maximum Peak Inverse Voltage
CMS2		688	Cmils	Output Winding Bare Conductor minimum circular mils
AWGS2		21	AWG	Wire Gauge (Rounded up to next larger standard AWG value)
DIAS2		0.73	mm	Minimum Bare Conductor Diameter
ODS2		1.54	mm	Maximum Outside Diameter for Triple Insulated Wire

3rd output

VO3			Volts	Output Voltage
IO3_AVG			Amps	Average DC Output Current
PO3_AVG		0.00	Watts	Average Output Power
VD3		0.7	Volts	Output Diode Forward Voltage Drop
NS3		0.38		Output Winding Number of Turns
ISRMS3		0.000	Amps	Output Winding RMS Current
IRIPPLE3		0.00	Amps	Output Capacitor RMS Ripple Current
PIVS3		2	Volts	Output Rectifier Maximum Peak Inverse Voltage
CMS3		0	Cmils	Output Winding Bare Conductor minimum circular mils
AWGS3		N/A	AWG	Wire Gauge (Rounded up to next larger standard AWG value)
DIAS3		N/A	mm	Minimum Bare Conductor Diameter
ODS3		N/A	mm	Maximum Outside Diameter for Triple Insulated Wire

Total Continuous Output Power

		35	Watts	Total Continuous Output Power
Negative Output		N/A		If negative output exists enter Output number; eg: If VO2 is negative output, enter 2



8 Performance Data

All measurements performed at room temperature, 60 Hz input frequency.

8.1 Efficiency

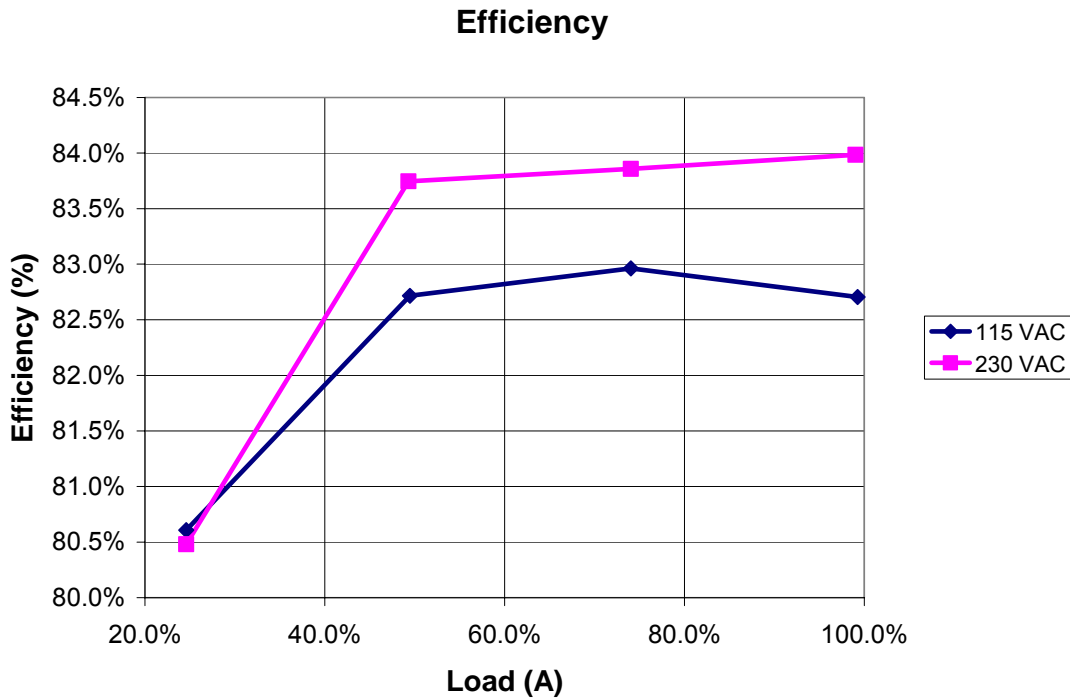

Figure 6 – Efficiency vs. Input Voltage, Room Temperature, 60 Hz.

8.1.1 Active Mode CEC Measurement Data

All single output adapters, including those provided with products, for sale in California after Jan 1st, 2008 must meet the California Energy Commission (CEC) requirement for minimum active mode efficiency and no load input power. Minimum active mode efficiency is defined as the average efficiency of 25, 50, 75 and 100% of rated output power with the limit based on the nameplate output power:

Nameplate Output (P_o)	Minimum Efficiency in Active Mode of Operation
< 1 W	$0.49 \times P_o$
≥ 1 W to ≤ 49 W	$0.09 \times \ln(P_o) + 0.5$ [ln = natural log]
> 49 W	0.85

For adapters that are single input voltage only, then the measurement is made at the rated single nominal input voltage (115 VAC or 230 VAC); for universal input adapters the measurement is made at both nominal input voltages (115 VAC and 230 VAC).



To meet the standar, the measured average efficiency (or efficiencies for universal input supplies) must be greater than or equal to the efficiency specified by the CEC/Energy Star standard.

Percent of Full Load	Efficiency (%)	
	115 VAC	230 VAC
25	80.6	80.5
50	82.7	83.7
75	83.0	83.9
100	82.7	84.0
Average	82.2	83.0
CEC specified minimum average efficiency (%)	82.0*	

*Although the CEC standard does not apply to this design, the data is provided for reference

More states within the USA and other countries are adopting this standard, for the latest up to date information please visit the PI Green Room:

<http://www.powerint.com/greenroom/regulations.htm>



8.2 No-load Input Power

No-Load Input Power

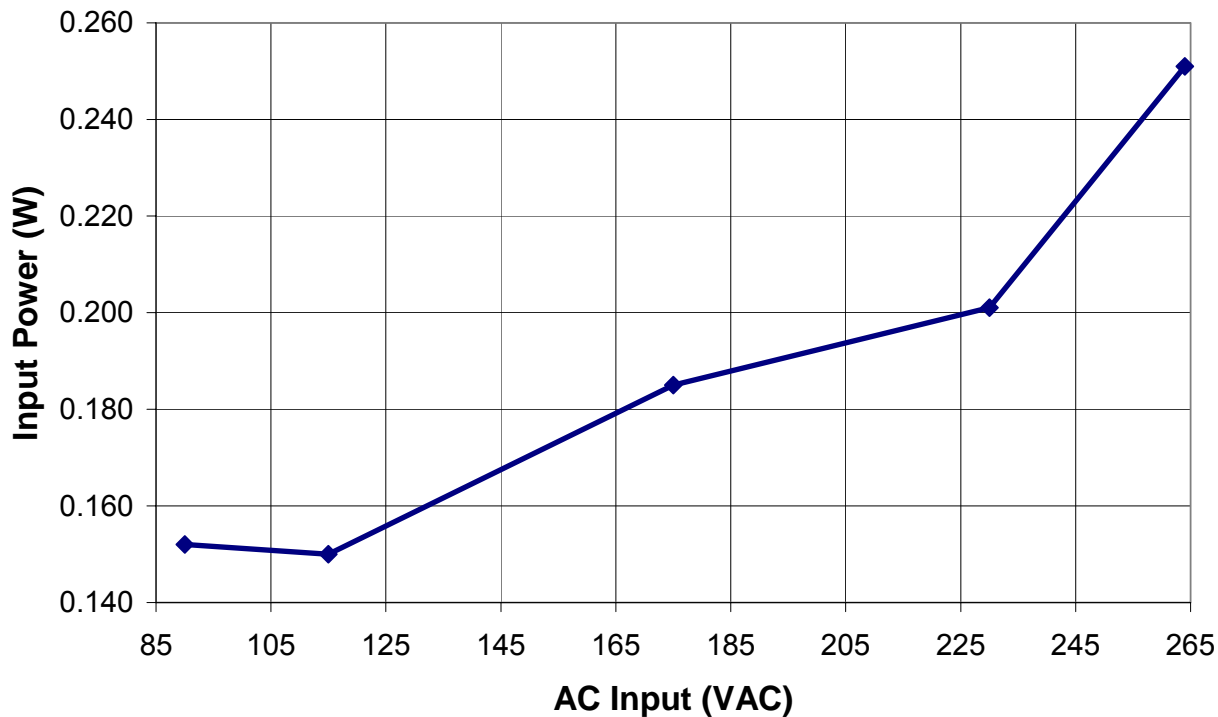

Figure 7 – Zero Load Input Power vs. Input Line Voltage, Room Temperature, 60 Hz.



8.3 Available Standby Output Power

The chart below shows the available output power vs line voltage for an input power of 1 W, 2 W and 3 W. This measurement was taken by loading the 5 Volt output.

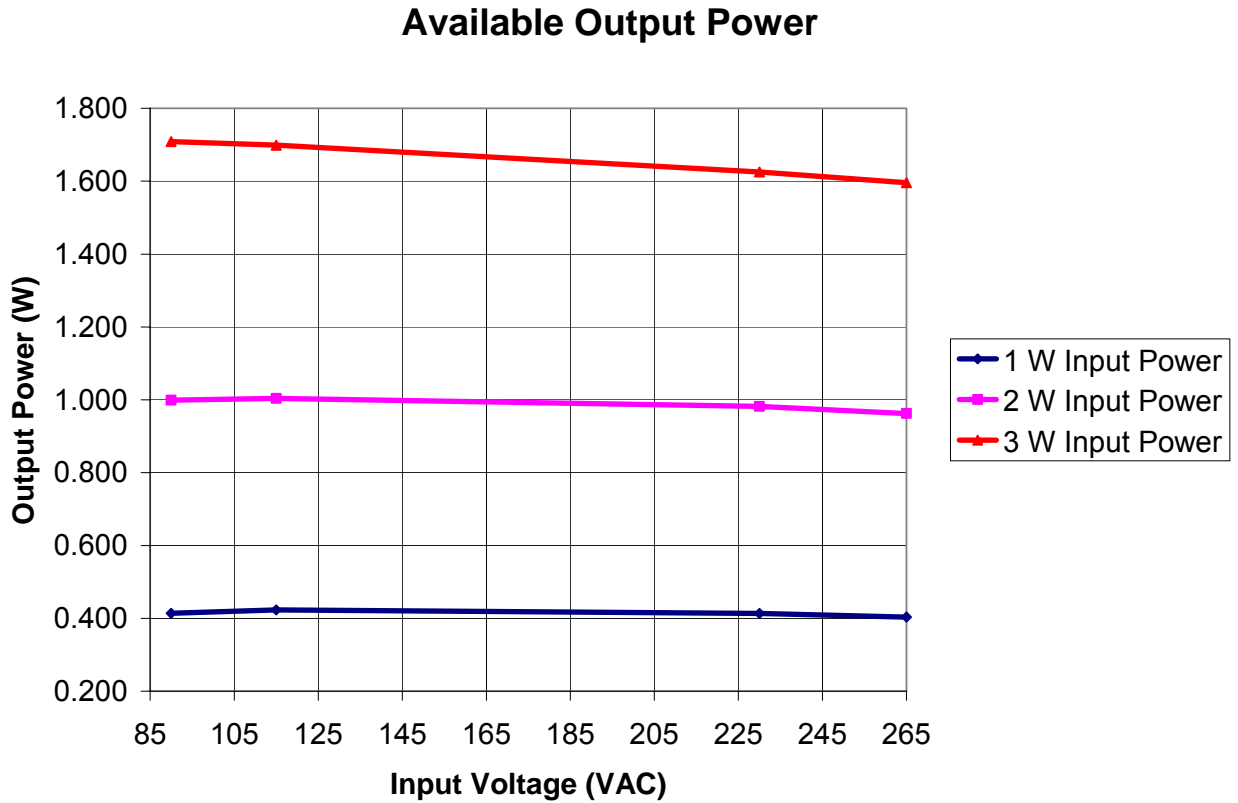

Figure 8 – Available Standby Output Power for Fixed Levels of Input Power



9 Regulation

9.1.1 Load

Load Regulation

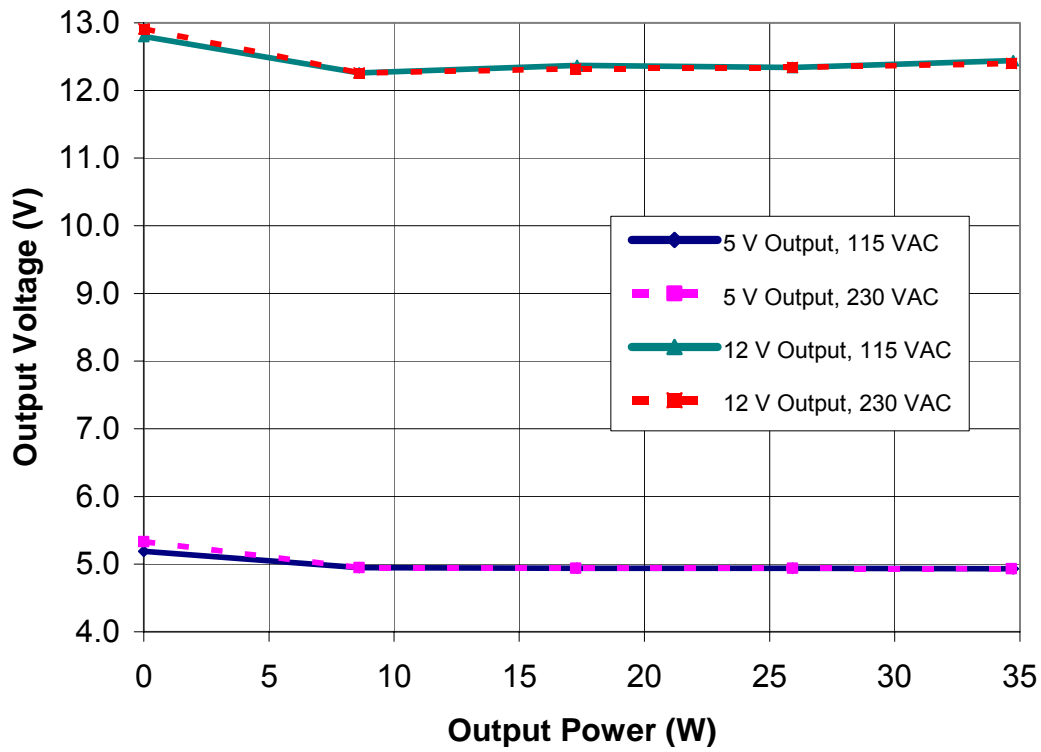

Figure 9 – Load Regulation, Room Temperature



9.1.2 Line

Line Regulation

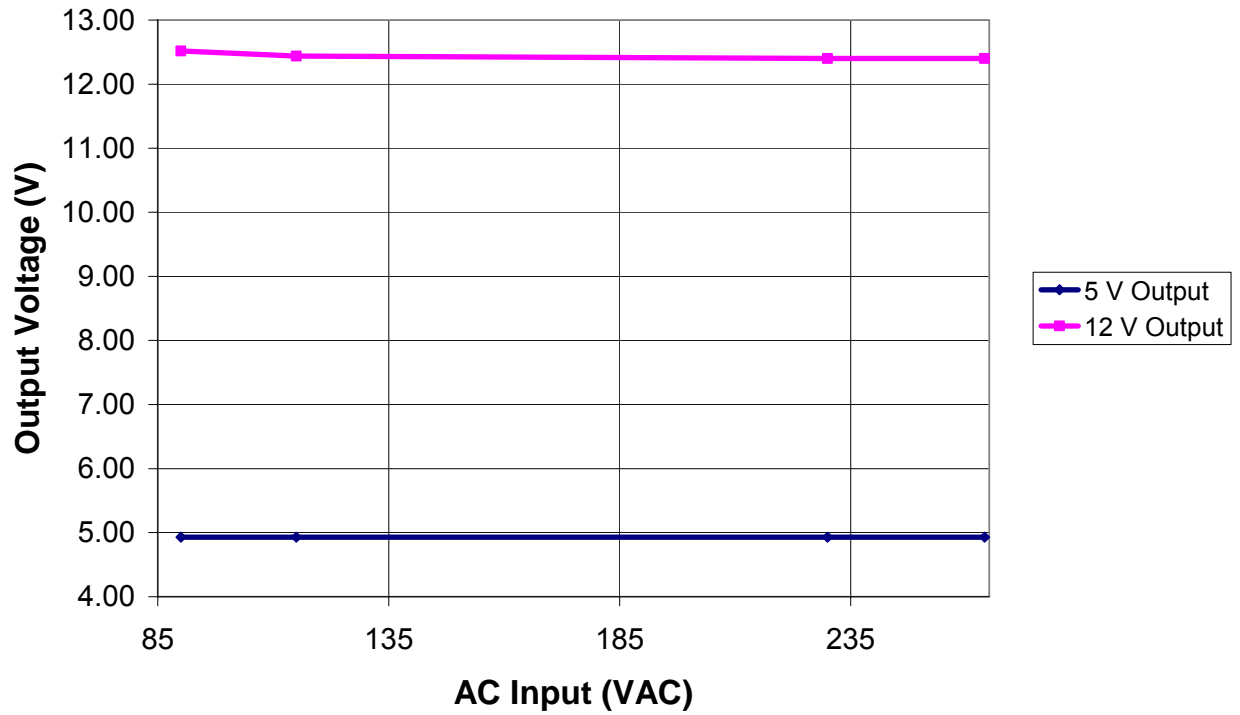

Figure 10 – Line Regulation, Room Temperature, Full Load



9.1.3 Cross Regulation Matrix

The table below shows the data for the outputs under various loading conditions at 90 and 265 VAC. The regulation on the 5 V output was within $\pm 5\%$ under all conditions.

90 VAC constant 50 mA load on 12 V				265 VAC constant 50 mA load on 12 V			
I _o (12 V)	I _o (5 V)	V _o (5 V)	V _o (12 V)	I _o (12 V)	I _o (5 V)	V _o (5 V)	V _o (12 V)
0.05	0.05	4.96	12.23	0.05	0.05	4.95	12.27
0.05	0.5	4.9	13.12	0.05	0.5	4.89	13.2
0.05	1	4.85	13.82	0.05	1	4.85	13.95
0.05	1.5	4.82	14.4	0.05	1.5	4.8	14.64
0.05	2.2	4.79	14.9	0.05	2.2	4.78	14.98

90 VAC - 12 V held constant at full load				265 VAC - 12 V held constant at full load			
I _o (12 V)	I _o (5 V)	V _o (5 V)	V _o (12 V)	I _o (12 V)	I _o (5 V)	V _o (5 V)	V _o (12 V)
2	0.05	4.99	11.7	2	0.05	4.99	11.66
2	0.5	4.97	12	2	0.5	4.97	11.97
2	1	4.96	12.14	2	1	4.96	12.1
2	1.5	4.95	12.27	2	1.5	4.95	12.22
2	2.2	4.94	12.4	2	2.2	4.94	12.33

90 VAC constant 50 mA load on 5 V				265 VAC constant 50 mA load on 5 V			
I _o (5 V)	I _o (12 V)	V _o (12 V)	V _o (5 V)	I _o (5 V)	I _o (12 V)	V _o (12 V)	V _o (5 V)
0.05	0.05	12.26	4.95	0.05	0.05	12.27	4.95
0.05	0.5	11.91	4.97	0.05	0.5	11.91	4.99
0.05	1	11.79	4.98	0.05	1	11.76	4.99
0.05	1.5	11.73	4.98	0.05	1.5	11.69	4.99
0.05	2	11.68	4.98	0.05	2	11.63	4.99

90 VAC constant 2.2 A load on 5 V				265 VAC constant 2.2 A load on 5 V			
I _o (5 V)	I _o (12 V)	V _o (12 V)	V _o (5 V)	I _o (5 V)	I _o (12 V)	V _o (12 V)	V _o (5 V)
2.2	0.05	14.96	4.78	2.2	0.05	14.87	4.8
2.2	0.5	12.91	4.91	2.2	0.5	12.96	4.91
2.2	1	12.54	4.94	2.2	1	12.55	4.93
2.2	1.5	12.42	4.94	2.2	1.5	12.98	4.94
2.2	2	12.36	4.94	2.2	2	12.32	4.94

Table 1 : Cross regulation data under various loading conditions



10 Thermal Performance

Measurements were taken with no air flow across the power supply.

Item	Temperature (°C)	
	90 VAC	265 VAC
Ambient	50	51
Output Capacitor (C17)	71	61
Transformer (T1)	87	87
Clamp Diode	96	91
TOPSwitch (U1) Source pin	108	91
Rectifier (D8)	89	88

Table 2 – Thermal Performance, Full Load

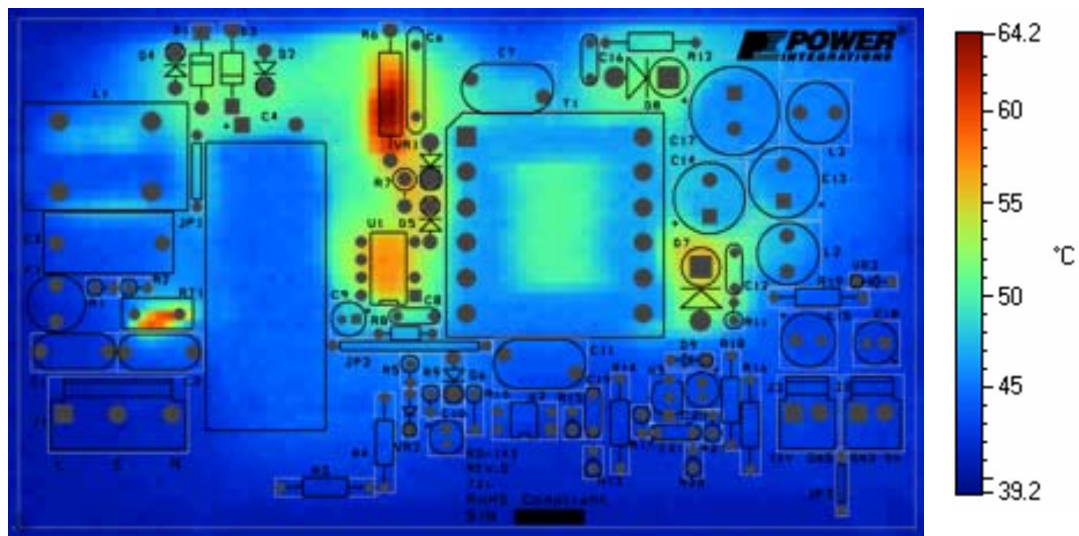

90 VAC, 35 W load, 21°C Ambient

Figure 11 – Infrared Thermograph of Open Frame Operation, at Room Temperature



11 Waveforms

11.1 Drain Voltage and Current, Normal Operation

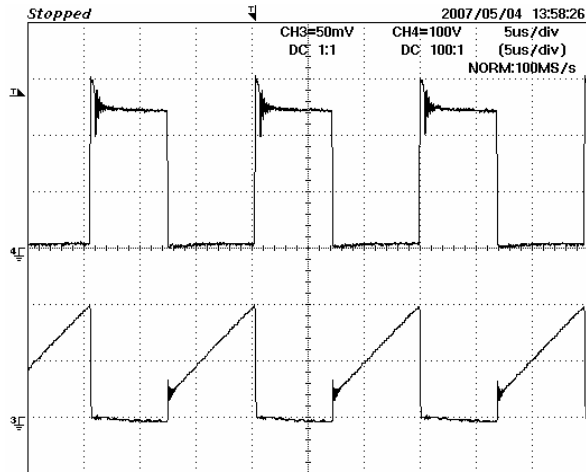

Figure 12 – 90 VAC, Full Load.
 Upper: V_{DRAIN} , 100 V, 5 μ s / div
 Lower: I_{DRAIN} , 0.5 A / div

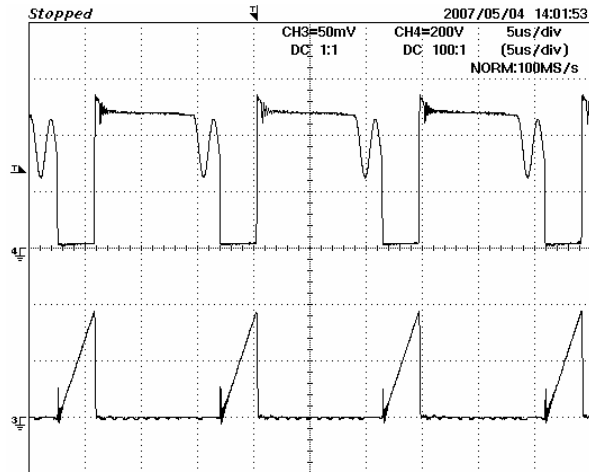

Figure 13 – 265 VAC, Full Load
 Upper: V_{DRAIN} , 200 V, 5 μ s / div
 Lower: I_{DRAIN} , 0.5 A / div

11.2 Output Voltage Start-up Profile

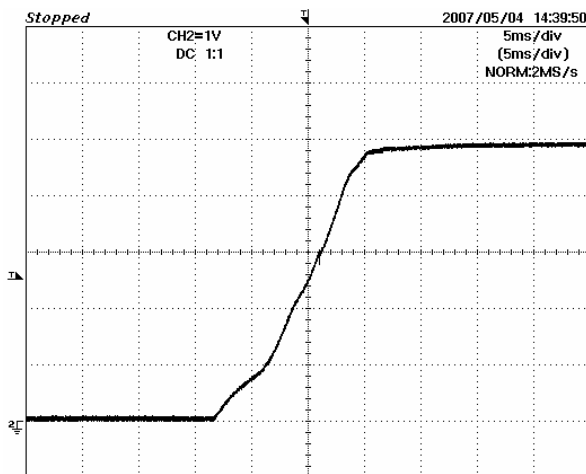

Figure 14 – 5 Volt Start-up Profile, Full load;
 90 VAC; 1 V/div, 5 ms / div.

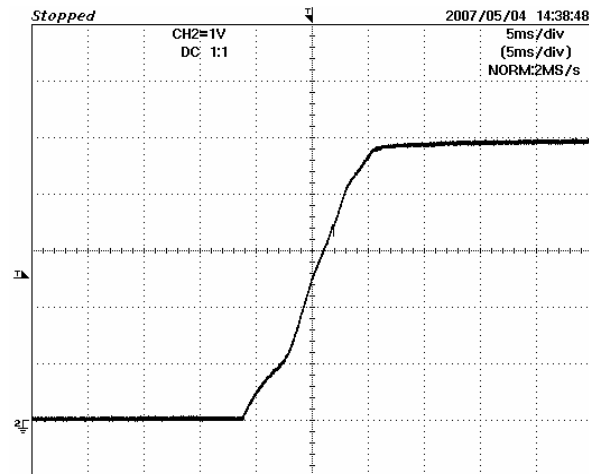

Figure 15 – 5 Volt Start-up Profile, Full load; 265
 VAC; 1 V/div, 5 ms / div.



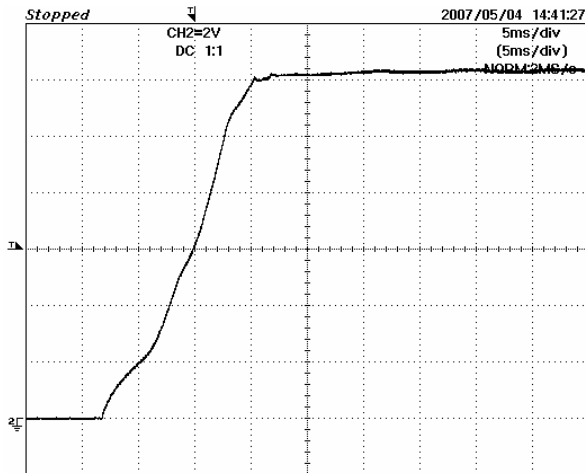

Figure 16 – 12 Volt Start-up Profile, Full load;
90 VAC; 2 V/div, 5 ms / div

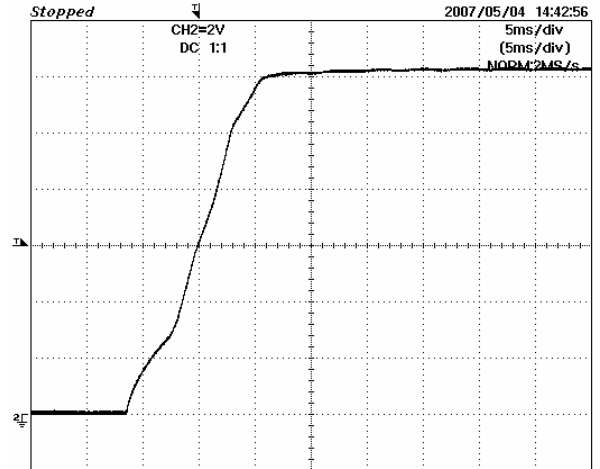

Figure 17 – 12 Volt Start-up Profile, Full load;
265 VAC; 2 V/div, 5 ms / div.



11.3 Drain Voltage and Current Start-up Profile

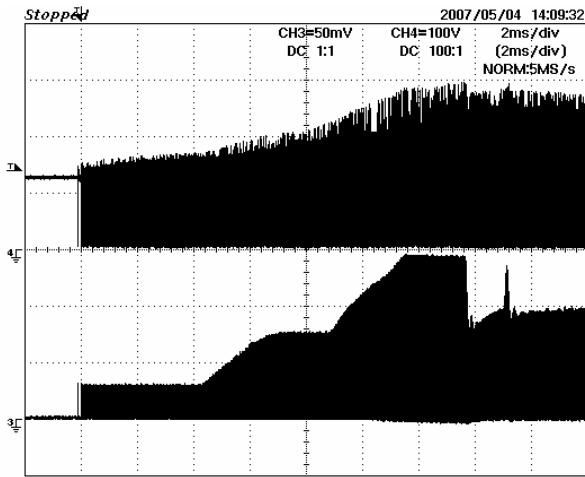

Figure 18 – 90 VAC Input and Maximum Load.
Upper: V_{DRAIN} , 100 V, 2 mS / div
Lower: I_{DRAIN} , 0.5 A / div.

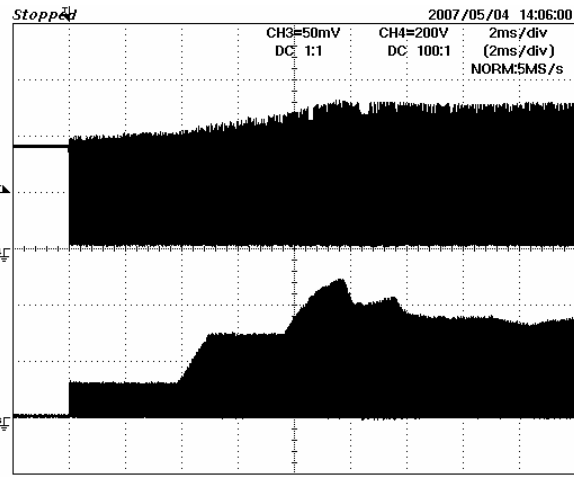

Figure 19 – 265 VAC Input and Maximum Load.
Upper: V_{DRAIN} , 200 V, 2 mS / div
Lower: I_{DRAIN} , 0.5 A / div.



11.4 Load Transient Response (75% to 100% Load Step)

In the figures shown below, signal averaging was used to better enable viewing of the load transient response. The oscilloscope was triggered using the load current step as a trigger source. Since the output switching and line frequency occur essentially at random with respect to the load transient, contributions to the output ripple from these sources will average out, leaving the contribution only from the load step response.

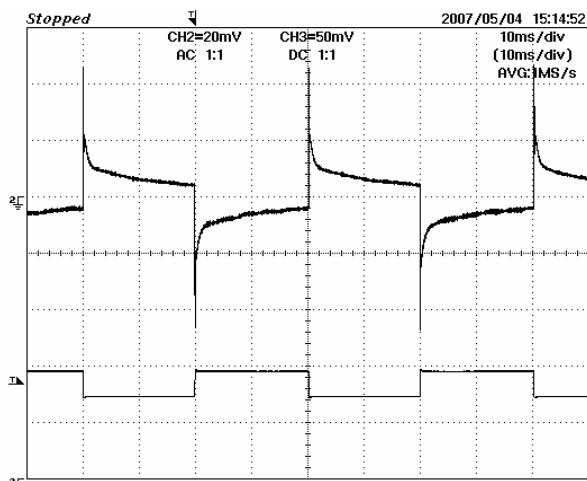

Figure 20 – 5 Volt Transient Response, 90 VAC, 75-100-75% Load Step.
Output Voltage 20 mV/div, Output Current 1 A / div, 10 ms / div.

Note: 12 volt output maintained at full load

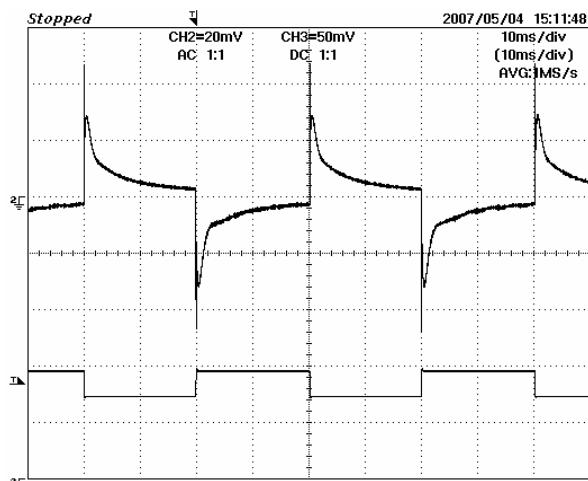

Figure 21 – 5 Volt Transient Response, 265 VAC, 75-100-75% Load Step
Output Voltage 20 mV/div, Output Current 1 A / div, 10 ms / div.

Note: 12 volt output maintained at full load



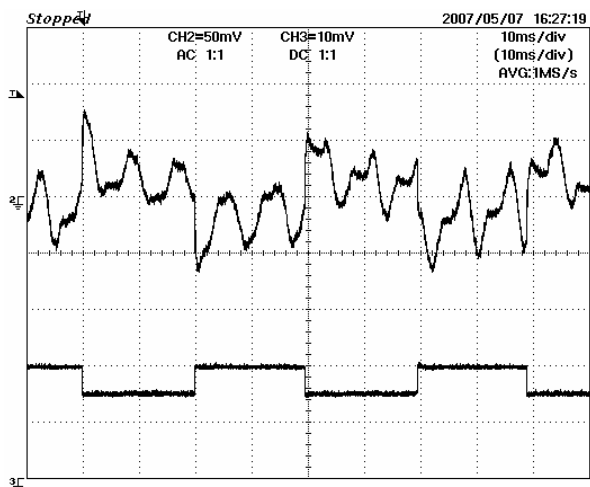

Figure 22 –12 Volt output in response to 5 V transient, 90 VAC, 75-100-75% Load Step
Output Voltage 50 mV/div, Output Current 1 A / div, 10 ms / div.

Note: 5 volt output maintained at full load (Waveshape is combination of line ripple and transient response - see figure 26)

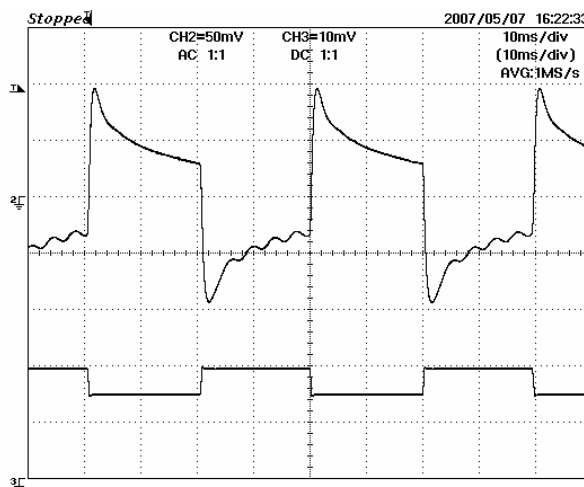

Figure 23 – 12 Volt output in response to 5 V transient, 265 VAC, 75-100-75% Load Step
Output Voltage 50 mV/div, Output Current 1 A / div, 10 ms / div.

Note: 5 volt output maintained at full load

11.5 Output Over-voltage Protection

The figures below show the performance of the output over-voltage protection circuit when the control loop was opened.

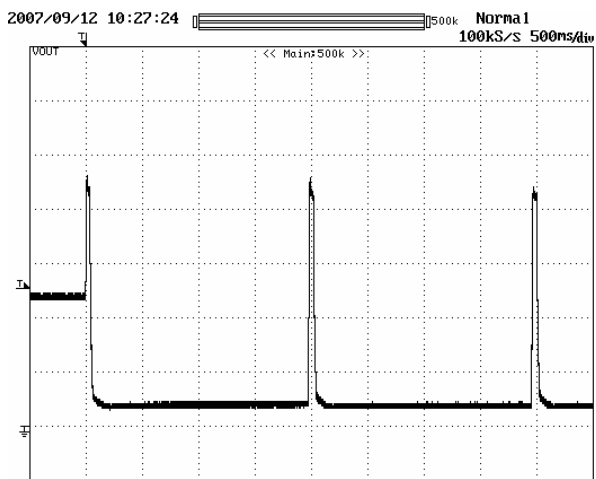

Figure 24 –5 Volt output in response to open loop R5 = 5.1 kΩ to configure hysteretic shutdown.
Output Voltage 2 V/div, 1 s / div.

Note: 12 V volt output maintained at no load

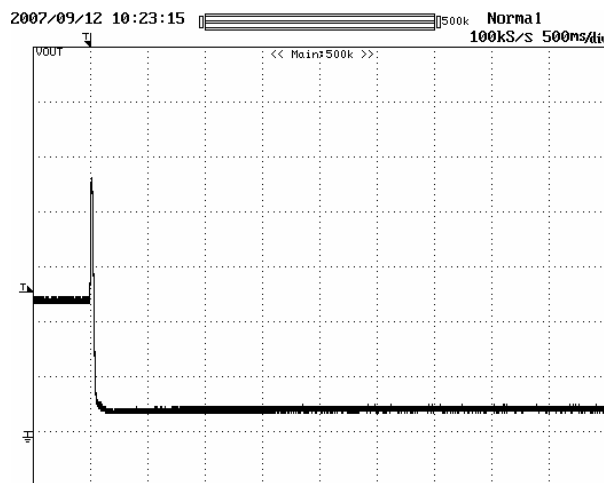

Figure 25 –5 Volt output in response to open loop R5 = 20 Ω to configure latching shutdown.
Output Voltage 2 V/div, 1 s / div.

Note: 12 V volt output maintained at no load



11.6 Output Ripple Measurements

11.6.1 Ripple Measurement Technique

For DC output ripple measurements, a modified oscilloscope test probe must be utilized in order to reduce spurious signals due to pickup. Details of the probe modification are provided below.

The 4987BA probe adapter is affixed with two capacitors tied in parallel across the probe tip. The capacitors include one (1) 0.1 $\mu\text{F}/50\text{ V}$ ceramic type and one (1) 1.0 $\mu\text{F}/50\text{ V}$ aluminum electrolytic. The aluminum electrolytic type capacitor is polarized, so proper polarity across DC outputs must be maintained (see below).

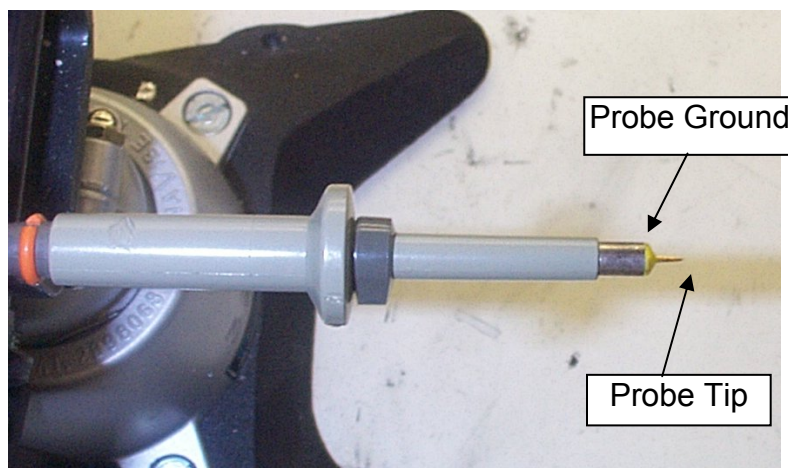

Figure 23 – Oscilloscope Probe Prepared for Ripple Measurement. (End Cap and Ground Lead Removed)



Figure 24 – Oscilloscope Probe with Probe Master (www.probemaster.com) 4987A BNC Adapter. (Modified with wires for ripple measurement, and two parallel decoupling capacitors added)

11.6.2 Measurement Results

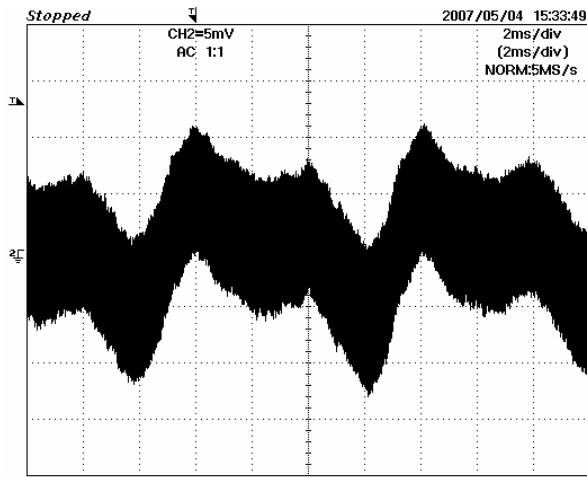

Figure 26 – 5 V Ripple, 90 VAC, Full Load.
2 ms, 5 mV / div

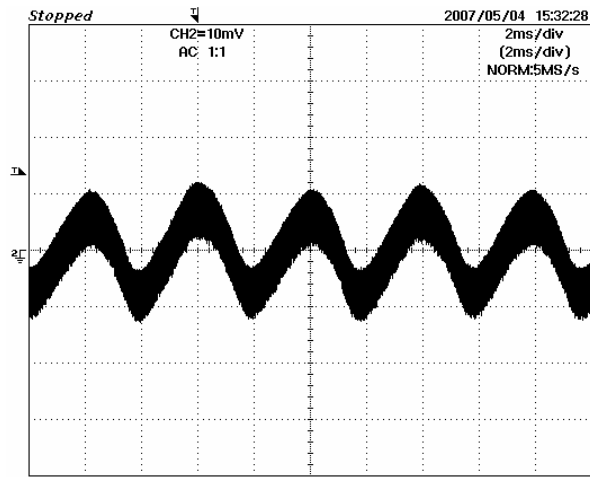

Figure 27 – 5 V Ripple, 115 VAC, Full Load.
2 ms, 10 mV / div

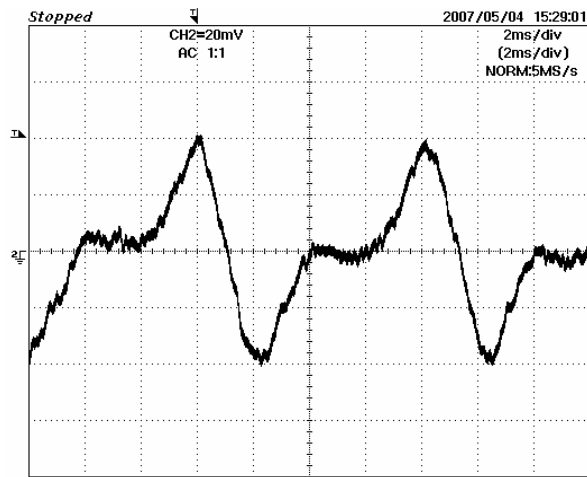

Figure 28 – 12 V Ripple, 90 VAC, Full Load.
2 ms, 20 mV / div

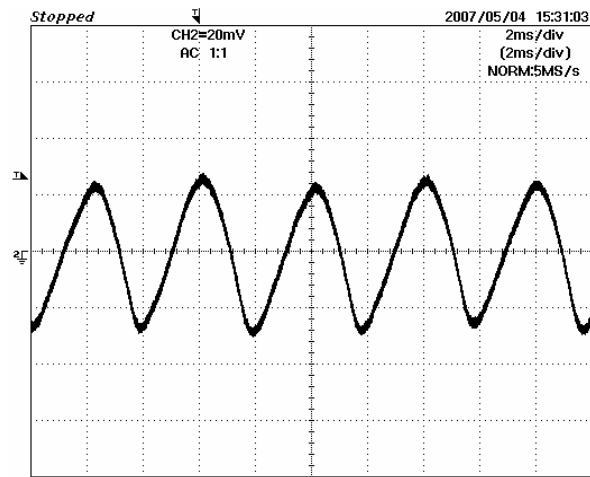

Figure 29– 12 V Ripple, 115 VAC, Full Load.
2 ms, 20 mV / div



12 Line Surge

Differential input line 1.2/50 μ s surge testing was completed on a single test unit to IEC61000-4-5. Input voltage was set at 230 VAC / 60 Hz. Output was loaded at full load and operation was verified following each surge event.

Surge Level (V)	Input Voltage (VAC)	Injection Location	Injection Phase (°)	Test Result (Pass/Fail)
+500	230	L to N	90	Pass
-500	230	L to N	270	Pass
+1000	230	L to N	90	Pass
-1000	230	L to N	270	Pass
+2000	230	L,N to G	90	Pass
-2000	230	L,N to G	270	Pass

Note: Unit passes under all test conditions.

Use a Slow Blow fuse at the input (F1) to increase differential surge withstand to 2 kV



13 Control Loop Measurements

13.1 90 VAC Maximum Load

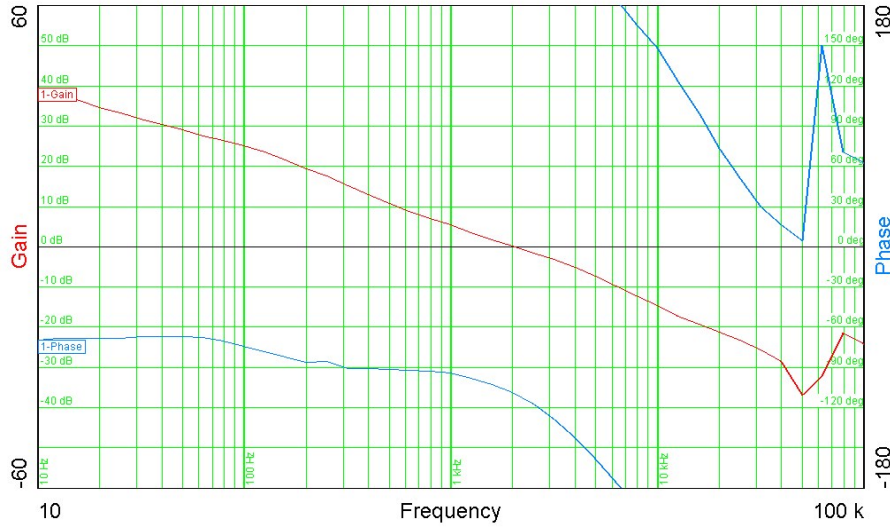

Figure 30 – Gain-Phase Plot, 90 VAC, Maximum Steady State Load
 Vertical Scale: Gain = 10 dB/div, Phase = 30 °/div.
 Crossover Frequency = 2.0 kHz Phase Margin = 65°

13.2 265 VAC Maximum Load

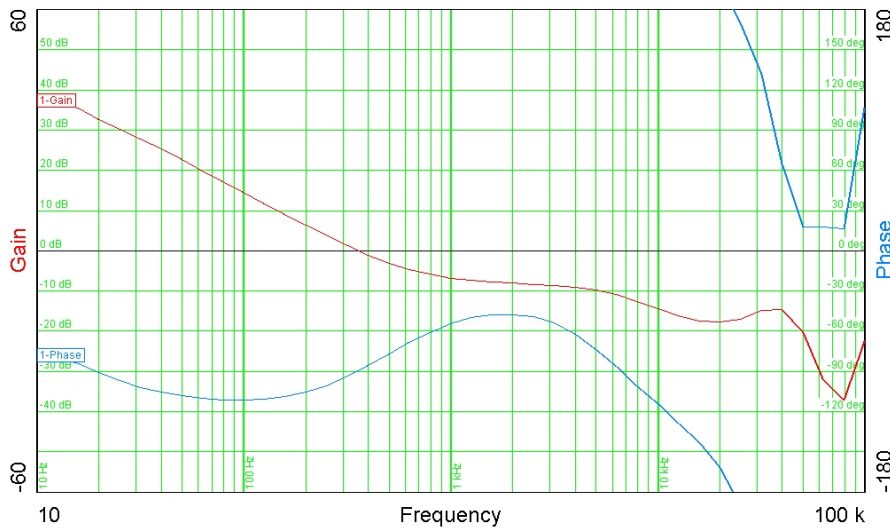

Figure 31 – Gain-Phase Plot, 265 VAC, Maximum Steady State Load
 Vertical Scale: Gain = 10 dB/div, Phase = 30 °/div.
 Crossover Frequency = 350 Hz, Phase Margin = 90°



14 Conducted EMI

Conducted EMI measurements were made with the output connected to the earth ground connection on the LISN. The result below represents the worst case results.

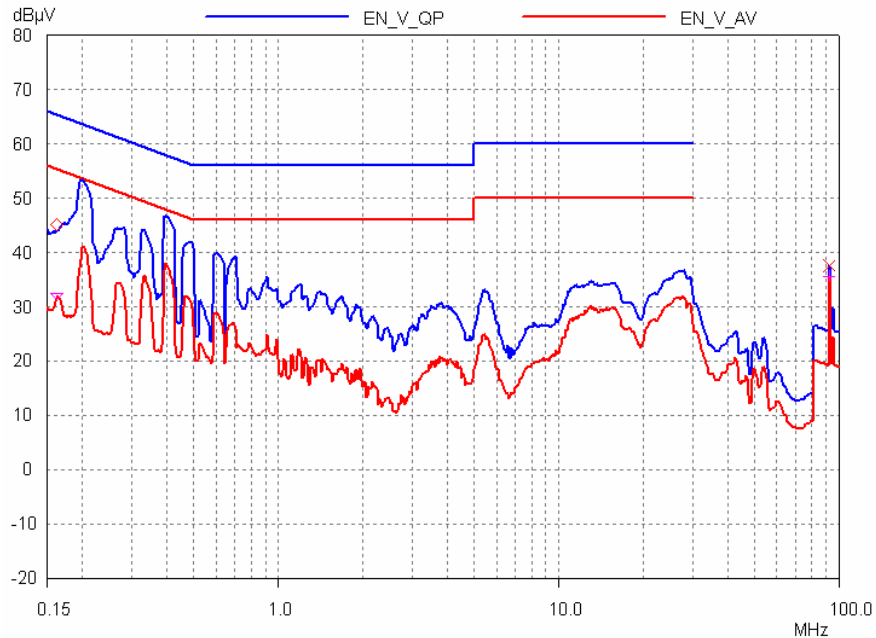

Figure 32 – Conducted EMI, Neutral Conductor, Maximum Steady State Load, 230 VAC, 60 Hz, and EN55022 B Limits.



15 Revision History

Date	Author	Revision	Description & changes	Reviewed
24-Sep-07	SGK	1.0	Initial Release	



For the latest updates, visit our website: www.powerint.com

Power Integrations reserves the right to make changes to its products at any time to improve reliability or manufacturability. Power Integrations does not assume any liability arising from the use of any device or circuit described herein. POWER INTEGRATIONS MAKES NO WARRANTY HEREIN AND SPECIFICALLY DISCLAIMS ALL WARRANTIES INCLUDING, WITHOUT LIMITATION, THE IMPLIED WARRANTIES OF MERCHANTABILITY, FITNESS FOR A PARTICULAR PURPOSE, AND NON-INFRINGEMENT OF THIRD PARTY RIGHTS.

PATENT INFORMATION

The products and applications illustrated herein (including transformer construction and circuits external to the products) may be covered by one or more U.S. and foreign patents, or potentially by pending U.S. and foreign patent applications assigned to Power Integrations. A complete list of Power Integrations' patents may be found at www.powerint.com. Power Integrations grants its customers a license under certain patent rights as set forth at <http://www.powerint.com/ip.htm>.

The PI Logo, *TOPSwitch*, *TinySwitch*, *LinkSwitch*, *DPA-Switch*, *PeakSwitch*, *EcoSmart*, *Clampless*, *E-Shield*, *Filterfuse*, *PI Expert* and *PI FACTS* are trademarks of Power Integrations, Inc. Other trademarks are property of their respective companies. ©Copyright 2006 Power Integrations, Inc.

Power Integrations Worldwide Sales Support Locations

WORLD HEADQUARTERS

5245 Hellyer Avenue
San Jose, CA 95138, USA.
Main: +1-408-414-9200
Customer Service:
Phone: +1-408-414-9665
Fax: +1-408-414-9765
e-mail: usasales@powerint.com

GERMANY

Rueckertstrasse 3
D-80336, Munich
Germany
Phone: +49-89-5527-3910
Fax: +49-89-5527-3920
e-mail: eurossales@powerint.com

JAPAN

Keihin Tatemono 1st Bldg
2-12-20
Shin-Yokohama, Kohoku-ku,
Yokohama-shi, Kanagawa ken,
Japan 222-0033
Phone: +81-45-471-1021
Fax: +81-45-471-3717
e-mail: japansales@powerint.com

TAIWAN

5F, No. 318, Nei Hu Rd., Sec. 1
Nei Hu Dist.
Taipei, Taiwan 114, R.O.C.
Phone: +886-2-2659-4570
Fax: +886-2-2659-4550
e-mail: taiwansales@powerint.com

CHINA (SHANGHAI)

Rm 807-808A,
Pacheer Commercial Centre,
555 Nanjing Rd. West
Shanghai, P.R.C. 200041
Phone: +86-21-6215-5548
Fax: +86-21-6215-2468
e-mail: chinasales@powerint.com

INDIA

261/A, Ground Floor
7th Main, 17th Cross,
Sadashivanagar
Bangalore, India 560080
Phone: +91-80-5113-8020
Fax: +91-80-5113-8023
e-mail: indiasales@powerint.com

KOREA

RM 602, 6FL
Korea City Air Terminal B/D,
159-6
Samsung-Dong, Kangnam-Gu,
Seoul, 135-728, Korea
Phone: +82-2-2016-6610
Fax: +82-2-2016-6630
e-mail: koreasales@powerint.com

EUROPE HQ

1st Floor, St. James's House
East Street, Farnham
Surrey, GU9 7TJ
United Kingdom
Phone: +44 (0) 1252-730-140
Fax: +44 (0) 1252-727-689
e-mail: eurossales@powerint.com

CHINA (SHENZHEN)

Room 2206-2207, Block A,
Elec. Sci. Tech. Bldg.
2070 Shennan Zhong Rd.
Shenzhen, Guangdong,
China, 518031
Phone: +86-755-8379-3243
Fax: +86-755-8379-5828
e-mail: chinasales@powerint.com

ITALY

Via Vittorio Veneto 12
20091 Bresso MI
Italy
Phone: +39-028-928-6000
Fax: +39-028-928-6009
e-mail: eurossales@powerint.com

SINGAPORE

51 Newton Road,
#15-08/10 Goldhill Plaza,
Singapore, 308900
Phone: +65-6358-2160
Fax: +65-6358-2015
e-mail: singaporesales@powerint.com

APPLICATIONS HOTLINE

World Wide +1-408-414-9660

APPLICATIONS FAX

World Wide +1-408-414-9760



