

Structure Silicon Monolithic Integrated Circuit

Product Name Synchronous rectification step-up DC/DC converter for mobile phone

Type **BD6071HFN**

**Under
Development**

Features Synchronous rectification step-up DC/DC converter
No external schottky diode required

○Absolute Maximum Ratings (Ta=25°C)

Parameter	Symbol	Rating	Unit	Condition
Maximum applied voltage1	VMAX1	7(*1)	V	VIN , EN , VFB , TEST
Maximum applied voltage2	VMAX2	20(*1)	V	SW , VOUT
Power dissipation	Pd	630(*2)	mW	
Operating temperature range	Topr	-30 to +85	°C	
Storage temperature range	Tstg	-55 to +150	°C	

(*1) These values are based on GND and GNDA pins.

(*2) This value is the measurement value that was mounted on the PCB by ROHM.

(70mm X 70mm X 1.6mm glass epoxy Board)

Temperature delecting: 5.04mW/°C from Ta>25°C

○Recommended operating conditions (Ta=-30 to +85°C)

Parameter	Symbol	Rating			Unit	Condition
		Min.	Typ.	Max.		
Supply voltage	Vin	2.7	3.6	5.5	V	

This product isn't designed to protect itself against radioactive rays.

Status of this document

The English version of this document is the formal specification.

A customer may use this translation version only for a reference to help reading the formal version.

If there are any differences in translation version of this document, formal version takes priority.

Application example

- ROHM cannot provide adequate confirmation of patents.
- The product described in this specification is designed to be used with ordinary electronic equipment or devices (such as audio-visual equipment, office-automation equipment, communications devices, electrical appliances, and electronic toys). Should you intend to use this product with equipment or devices which require an extremely high level of reliability and the malfunction of which would directly endanger human life (such as medical instruments, transportation equipment, aerospace machinery, nuclear-reactor controllers, fuel controllers and other safety devices), please be sure to consult with our sales representative in advance.
- ROHM assumes no responsibility for use of any circuits described herein, conveys no license under any patent or other right, and makes no representations that the circuits are free from patent infringement.

○Electrical Characteristics

(Unless otherwise noted, Ta = +25°C, Vin=3.6V)

Parameter	Symbol	Spec			Unit	Condition
		Min.	Typ.	Max.		
EN Terminal						
EN Low threshold voltage	VthL	-	-	0.4	V	
EN High threshold voltage	VthH	1.4	-	-	V	
EN Input current	Iin	-	18.3	30.0	μA	EN=5.5V
EN Output current	Iout	-2.0	-0.1	-	μA	EN=0
Switching Regulator						
Input voltage range	Vin	3.1	-	5.5	V	
Quiescent Current	Iq	-	0.1	2.0	μA	EN=0V
Current Consumption	Idd	-	1.1	1.5	mA	EN=2.6V,VFB=1.0V,VIN=3.6V
Feedback voltage	Vfb	0.47	0.50	0.53	V	
Inductor current limit	Icoil	200	265	330	mA	Vin=3.6V (*1)
SW saturation voltage	Vsat	-	0.14	0.28	V	Isw=200mA,Vin=3.6V
SW on resistance P	Ronp	-	2.1	3.2	Ω	Ipch=200mA,Vout=13V
Switching frequency	fSW	0.8	1.0	1.2	MHz	
Duty cycle limit	Duty	82.7	85.0	-	%	VFB=0V
Output voltage range	Vo	-	-	14.0	V	
Over voltage limit	Ovl	14.0	14.5	15.0	V	VFB=0V
Start up time	Ts	-	0.5	1.0	ms	

*1. This parameter is tested with dc measurement.

External dimensions

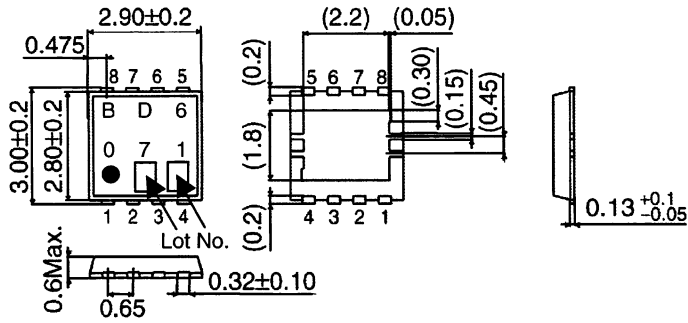

Terminals

PIN	PIN Name
1	GNDA
2	EN
3	TEST
4	VFB
5	GND
6	SW
7	VOUT
8	VIN

HSON8(8Pin) (Unit : mm)

Block diagram

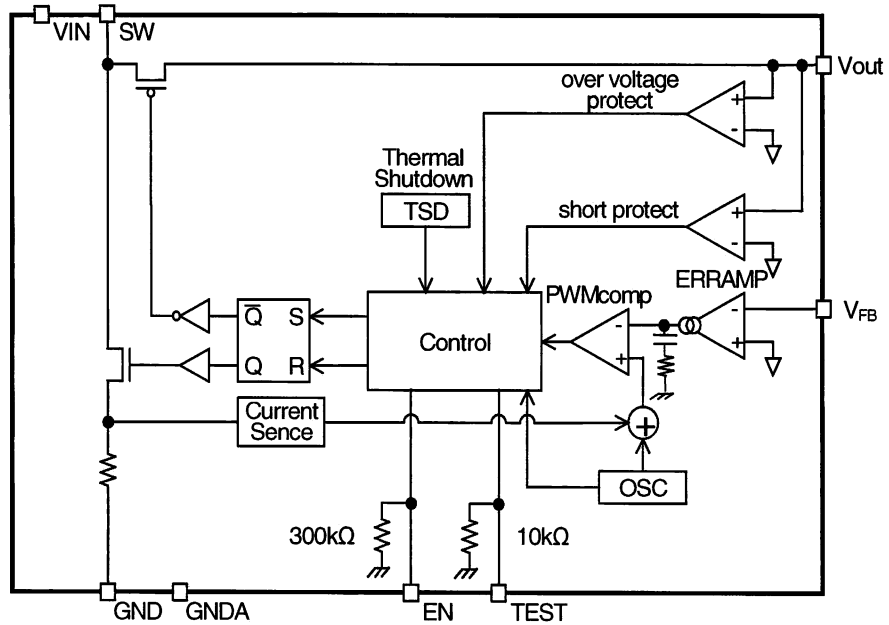

○Cautions on use

(1) Absolute Maximum Ratings

An excess in the absolute maximum ratings, such as supply voltage, temperature range of operating conditions, etc., can break down devices, thus making impossible to identify breaking mode such as a short circuit or an open circuit. If any special mode exceeding the absolute maximum ratings is assumed, consideration should be given to take physical safety measures including the use of fuses, etc.

(2) Power supply and GND line

Design PCB pattern to provide low impedance for the wiring between the power supply and the GND lines. Pay attention to the interference by common impedance of layout pattern when there are plural power supplies and GND lines. Especially, when there are GND pattern for small signal and GND pattern for large current included the external circuits, please separate each GND pattern. Furthermore, for all power supply terminals to ICs, mount a capacitor between the power supply and the GND terminal. At the same time, in order to use a capacitor, thoroughly check to be sure the characteristics of the capacitor to be used present no problem including the occurrence of capacity dropout at a low temperature, thus determining the constant.

(3) GND voltage

Make setting of the potential of the GND terminal so that it will be maintained at the minimum in any operating state. Furthermore, check to be sure no terminals are at a potential lower than the GND voltage including an actual electric transient.

(4) Short circuit between terminals and erroneous mounting

In order to mount ICs on a set PCB, pay thorough attention to the direction and offset of the ICs. Erroneous mounting can break down the ICs. Furthermore, if a short circuit occurs due to foreign matters entering between terminals or between the terminal and the power supply or the GND terminal, the ICs can break down.

(5) Operation in strong electromagnetic field

Be noted that using ICs in the strong electromagnetic field can malfunction them.

(6) Input terminals

In terms of the construction of IC, parasitic elements are inevitably formed in relation to potential. The operation of the parasitic element can cause interference with circuit operation, thus resulting in a malfunction and then breakdown of the input terminal. Therefore, pay thorough attention not to handle the input terminals, such as to apply to the input terminals a voltage lower than the GND respectively, so that any parasitic element will operate. Furthermore, do not apply a voltage to the input terminals when no power supply voltage is applied to the IC. In addition, even if the power supply voltage is applied, apply to the input terminals a voltage lower than the power supply voltage or within the guaranteed value of electrical characteristics.

(7) External capacitor

In order to use a ceramic capacitor as the external capacitor, determine the constant with consideration given to a degradation in the nominal capacitance due to DC bias and changes in the capacitance due to temperature, etc.

(8) Thermal shutdown circuit (TSD)

When junction temperatures become 175°C (typ) or higher, the thermal shutdown circuit operates and turns a switch OFF. The thermal shutdown circuit, which is aimed at isolating the LSI from thermal runaway as much as possible, is not aimed at the protection or guarantee of the LSI. Therefore, do not continuously use the LSI with this circuit operating or use the LSI assuming its operation.

(9) Thermal design

Perform thermal design in which there are adequate margins by taking into account the permissible dissipation (Pd) in actual states of use.

(10) DC/DC converter

Please select the low DCR inductors to decrease power loss for DC/DC converter.

Notes

- No technical content pages of this document may be reproduced in any form or transmitted by any means without prior permission of ROHM CO.,LTD.
- The contents described herein are subject to change without notice. The specifications for the product described in this document are for reference only. Upon actual use, therefore, please request that specifications to be separately delivered.
- Application circuit diagrams and circuit constants contained herein are shown as examples of standard use and operation. Please pay careful attention to the peripheral conditions when designing circuits and deciding upon circuit constants in the set.
- Any data, including, but not limited to application circuit diagrams information, described herein are intended only as illustrations of such devices and not as the specifications for such devices. ROHM CO.,LTD. disclaims any warranty that any use of such devices shall be free from infringement of any third party's intellectual property rights or other proprietary rights, and further, assumes no liability of whatsoever nature in the event of any such infringement, or arising from or connected with or related to the use of such devices.
- Upon the sale of any such devices, other than for buyer's right to use such devices itself, resell or otherwise dispose of the same, no express or implied right or license to practice or commercially exploit any intellectual property rights or other proprietary rights owned or controlled by
- ROHM CO., LTD. is granted to any such buyer.
- Products listed in this document are no antiradiation design.

The products listed in this document are designed to be used with ordinary electronic equipment or devices (such as audio visual equipment, office-automation equipment, communications devices, electrical appliances and electronic toys).

Should you intend to use these products with equipment or devices which require an extremely high level of reliability and the malfunction of which would directly endanger human life (such as medical instruments, transportation equipment, aerospace machinery, nuclear-reactor controllers, fuel controllers and other safety devices), please be sure to consult with our sales representative in advance.

About Export Control Order in Japan

Products described herein are the objects of controlled goods in Annex 1 (Item 16) of Export Trade Control Order in Japan.

In case of export from Japan, please confirm if it applies to "objective" criteria or an "informed" (by MITI clause) on the basis of "catch all controls for Non-Proliferation of Weapons of Mass Destruction.

Thank you for your accessing to ROHM product informations.
More detail product informations and catalogs are available,
please contact your nearest sales office.

Please contact our sales offices for details ;

U.S.A / San Diego	TEL : +1(858)625-3630	FAX : +1(858)625-3670
Atlanta	TEL : +1(770)754-5972	FAX : +1(770)754-0691
Dallas	TEL : +1(972)312-8818	FAX : +1(972)312-0330
Germany / Dusseldorf	TEL : +49(2154)9210	FAX : +49(2154)921400
United Kingdom / London	TEL : +44(1)908-282-666	FAX : +44(1)908-282-528
France / Paris	TEL : +33(0)1 56 97 30 60	FAX : +33(0) 1 56 97 30 80
China / Hong Kong	TEL : +852(2)740-6262	FAX : +852(2)375-8971
Shanghai	TEL : +86(21)6279-2727	FAX : +86(21)6247-2066
Dilian	TEL : +86(411)8230-8549	FAX : +86(411)8230-8537
Beijing	TEL : +86(10)8525-2483	FAX : +86(10)8525-2489
Taiwan / Taipei	TEL : +866(2)2500-6956	FAX : +866(2)2503-2869
Korea / Seoul	TEL : +82(2)8182-700	FAX : +82(2)8182-715
Singapore	TEL : +65-6332-2322	FAX : +65-6332-5662
Malaysia / Kuala Lumpur	TEL : +60(3)7958-8355	FAX : +60(3)7958-8377
Philippines / Manila	TEL : +63(2)807-6872	FAX : +63(2)809-1422
Thailand / Bangkok	TEL : +66(2)254-4890	FAX : +66(2)256-6334

Japan /
(Internal Sales)

Tokyo	2-1-1, Yaesu, Chuo-ku, Tokyo 104-0082	TEL : +81(3)5203-0321	FAX : +81(3)5203-0300
Yokohama	2-4-8, Shin Yokohama, Kohoku-ku, Yokohama, Kanagawa 222-8575	TEL : +81(45)476-2131	FAX : +81(45)476-2128
Nagoya	Dainagayo Building 9F 3-28-12, Meieki, Nakamura-ku, Nagoya, Aichi 450-0002	TEL : +81(52)581-8521	FAX : +81(52)561-2173
Kyoto	579-32 Higashi Shiokouji-cho, Karasuma Nishi-iru, Shiokoujidori, Shimogyo-ku, Kyoto 600-8216	TEL : +81(75)311-2121	FAX : +81(75)314-6559

(Contact address for overseas customers in Japan)

Yokohama	TEL : +81(45)476-9270	FAX : +81(045)476-9271
----------	-----------------------	------------------------