

Kunde / customer :

Artikelnummer / part number : **82533300**

Datum / Date : **01.06.10**

Bezeichnung :

description : **HIGH SURGE 1210 SMD VARISTOR Lead Free SMD size: 1210 ROHS Compliant**

A Mechanische Abmessungen / dimensions :

SIZE (Unit : mm)

SISE	W	L	T	a
0402	0.5	1.0	0.6	0.25
0603	0.8	1.6	0.9	0.3
0805	1.25	2.0	1.2	0.3
1206	1.6	3.2	1.5	0.5
1210	2.5	3.2	1.5	0.5
1812	3.2	4.5	2.0	0.5
2220	5.0	5.7	2.5	0.5

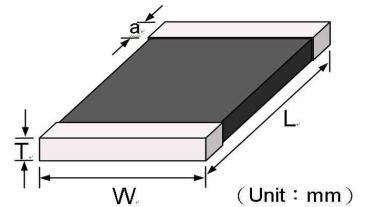

B Elektrische Eigenschaften / electrical properties :

TECHNICAL DATA

Part Number	Working Voltage		Clamping Voltage	Peak Current	Energy	Breakdown Voltage	Capacitance
	AC	DC					
82533300	30	38	85	400	2.0	47 (43.24~50.76)	1000

- * 1 The varistor voltage was measured at 1 mA current , tolerance at 12~18V(+/-15%), exceed 22V (+/-10%) Or tolerance to specify at : -
- * 2 The Clamping voltage tolerance at 12~18V(+/-15%), exceed 22V (+/-10%). Clamping voltage measured at standard current (A) : 2.5 A
- * 3 The Peak Current was tested at 8/20 us waveform
- * 4. The capacitance value and Energy only for customer reference, it's not formal specification Capacitance value measured at standard frequency : 1 kHz

SURGE LEVEL IEC61000-4-5

Severity Level	(kV)
1	0,5
2	1
3	2
4	4
X	Special

Wave shape "Short circuit" (Current I_{sc})

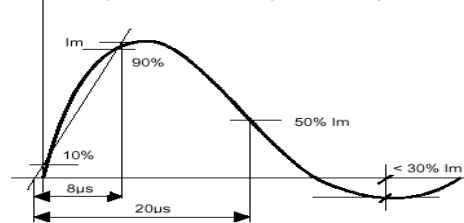

Wave during	T1	T2
8/20 µs	8 µs	20 µs
10/700 µs CCITT	10 µs	700 µs
10/1000 µs	10 µs	1000 µs

REFERENCE DATA

Response time	T _{rise}	<	1	ns
Leakage current at V _v × 80%	I _{v v}	<	50	µA
Leakage current at V _v × 80% (After reliability Test)	I _{v v A}	<	200	µA
Operating ambient temperature			-40~+85	°C
Storage temperature			-50~+125	°C
Max. temperature solder			260	°C

OTHER DATA

Body	ZnO
End termination	Ag/Ni/Sn
Packaging	Reel
Complies with Standard	IEC61000-4-5
Procedure	Solgel
Marking	None

Würth Elektronik eiSos GmbH & Co.KG - Radialex department

D-74638 Waldenburg · Max-Eyth-Straße 1 - 3 · Germany · Telefon (+49) (0) 7942 - 945 - 0 · Telefax (+49) (0) 7942 - 945 - 400
<http://www.we-online.com>

Kunde / customer :

Artikelnummer / part number : **82533300**

Bezeichnung :

description : **HIGH SURGE 1210 SMD VARISTOR**

SMD size: **1210**

C Lötpad / soldering spec. :

RECOMMENDED SOLDER PAD LAYOUT

(Unit : mm)

SISE	A	B	C	D
402	0.4~0.6	1.0~1.8	0.6~0.7	0.6~1.2
603	0.8~1.2	1.7~3.0	1.2~1.6	0.9~1.8
805	1.0~1.5	2.1~3.8	1.5~2.1	1.1~2.3
1206	1.8~2.5	3.0~5.8	1.8~2.6	1.2~3.3
1210	1.8~2.5	3.2~6.1	2.8~3.8	1.3~3.5
1812	2.5~3.5	4.0~7.3	3.3~4.5	1.5~3.8
2220	3.5~4.6	5.0~8.5	5.2~6.2	1.5~3.9
3220	5.2~6.4	9.5~10.8	5.6~6.0	2.0~2.8

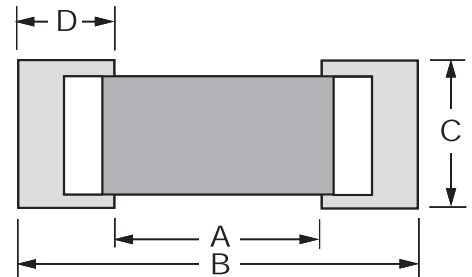

- 1 - The solder paste shall be printed in a thickness of 150 to 200µm.
- 2 - The SIR test of the solder paste shall be done (Based on JIS-Z-3284)
- 3 - IR reflow Pb Free Process suggestin profile (Based on J-STD-020-C):

Rapid heating, partial heating or rapid cooling will easily cause defect of the component. So preheating and gradual cooling process is suggested. IR soldering has the highest yields due to controlled heating rates and solder liquidus times. Make sure that the element is not subjected to a thermal gradient steeper than 3 degrees per second. 2 degrees per second is the ideal gradient. During the soldering process, pre- heating to within 175 degrees of the solders peak temperature is essential to minimize thermal shock.

Soldering recommend paste is Sn 96.5/Ag 3.5

- Preheat
 - 1.The temperature rising speed is suggested to be 2~3°C/s.
 - 2.Appropriate preheat time will be from 60 to 120 seconds.
 - 3.Temp. maintain at 175 +/-25°C 120 seconds.
- Heating
 - 1.Careful about sudden rise in temperature as it may worsen the solder ability.
 - 2.Set the peak temperature in 235°C 10-20s or 260°C 3-10s.
- Cooling
 - 1.Ramp down rate 6°C/s max.

※Perform adequate test in advance as the reflow temperature profile will vary according to the conditions of the manufacturing process, and the specification of the reflow furnace

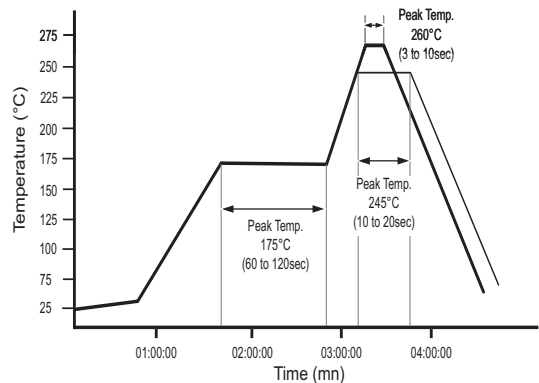

4 - Wave Soldering Process

- Ramp-up rate 3°C/s max.
- Temp. maintain at 175 +/-25°C 180 seconds max.
- Peak temperature 260°C 3-10s.
- Ramp down rate 6°C/s max.
- to thermal shock, a preheat is recommended in the soldering process. and the peak temperature should be under controlled rigidly in the solder process.



5 - Hand Soldering Process

- Preheating 150°C
- Temperature of soldering iron tip 380°C max. 3 to 5 sec
- The Varistorrs shall be cooled gradually at room ambient temperature

6 - Ultrasonic cleaning

- For preventing failures or damages. Frequency 29MHz max - radied Power 20W/l max - Period 5mn max

Würth Elektronik eiSos GmbH & Co.KG - Radialex department

D-74638 Waldenburg · Max-Eyth-Straße 1 - 3 · Germany · Telefon (+49) (0) 7942 - 945 - 0 · Telefax (+49) (0) 7942 - 945 - 400

<http://www.we-online.com>

Kunde / customer :

Artikelnummer / part number : **82533300**

Bezeichnung :

description : **HIGH SURGE 1210 SMD VARISTOR**

SMD size: **1210**

D Rollenspezifikation / tape and reel specification :

- 1 - Carrier tape and transparent cover tape should be heat-sealed to carry the products, and the reel should be used to reel the carrier tape.
- 2 - The adhesion of the heat-sealed cover tape shall be 40 + 20/ - 15grams.
- 3 - Both the head and the end portion of the taping shall be empty for reel package and SMT auto-pickup machine.
And a normal paper tape shall be connected in the head of taping for the operator to handle.

(Unit : mm)

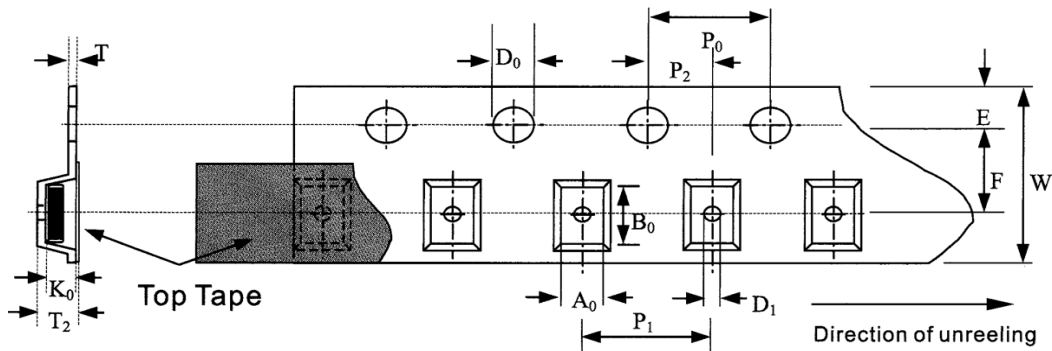

TAPE SPECIFICATION

(Unit : mm)

Symbol	A ₀ ±0.10	B ₀ ±0.10	K ₀ ±0.10	T ₂ ±0.05	T ±0.05	D ₀ +0.10	D ₁ ±0.05	P ₁ ±0.10	P ₂ ±0.05	P ₀ ±0.05	W ±0.20	E ±0.10	F ±0.05
0402	0.85	1.25	0.65	0.22	0.10	1.50	1.00	4.00	2.00	4.00	8.00	1.75	3.50
0603	1.05	1.88	0.95	0.22	0.10	1.50	1.00	4.00	2.00	4.00	8.00	1.75	3.50
0805	1.42	2.30	1.04	0.22	0.10	1.50	1.00	4.00	2.00	4.00	8.00	1.75	3.50
1206	1.88	3.50	1.27	0.2	0.10	1.50	1.00	4.00	2.00	4.00	8.00	1.75	3.50
1210	2.18	3.46	1.45	0.22	0.10	1.50	1.00	4.00	2.00	4.00	8.00	1.75	3.50
1812	3.66	4.95	1.74	0.25	0.10	1.50	1.50	8.00	2.00	4.00	12.00	1.75	5.50
2220	5.10	5.97	2.80	0.25	0.10	1.50	1.50	8.00	2.00	4.00	12.00	1.75	5.50

Kunde / customer :

Artikelnummer / part number : **82533300**

Bezeichnung :

description : **HIGH SURGE 1210 SMD VARISTOR**

SMD size: **1210**

D Rollenspezifikation / tape and reel specification :

(Unit : mm)

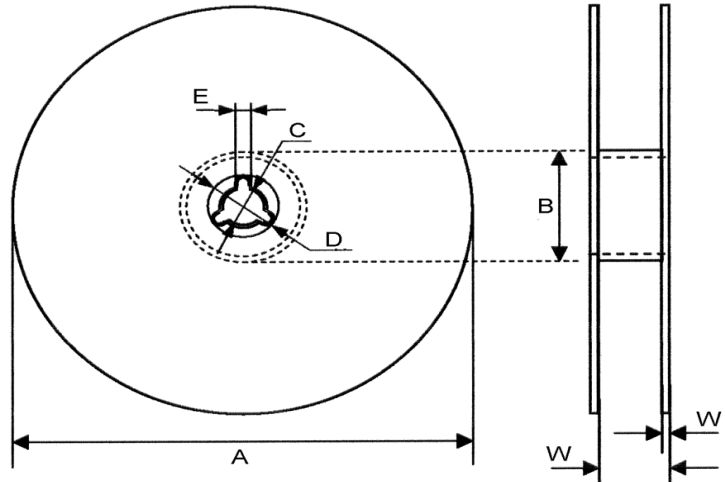

REEL DIMENSION

(Unit : mm)

Symbol	A	B	C	D	E	W	W ₁
0402	178.0±1.0	60.0±0.5	13.0±0.2	21.0±0.2	2.0±0.5	9.0±0.50	1.5±0.15
0603	178.0±1.0	60.0±0.5	13.0±0.2	21.0±0.2	2.0±0.5	9.0±0.50	1.5±0.15
0805	178.0±1.0	60.0±0.5	13.0±0.2	21.0±0.2	2.0±0.5	9.0±0.50	1.5±0.15
1206	178.0±1.0	60.0±0.5	13.0±0.2	21.0±0.2	2.0±0.5	9.0±0.50	1.5±0.15
1210	178.0±1.0	60.0±0.5	13.0±0.2	21.0±0.2	2.0±0.5	9.0±0.50	1.5±0.15
1812	178.0±1.0	60.0±0.5	13.5±0.1	21.0±0.2	2.0±0.5	13.6±0.2	1.5±0.15
2220	178.0±1.0	60.0±0.5	13.5±0.1	21.0±0.2	2.0±0.5	13.6±0.2	1.5±0.15

* 2.0 mm for 361 and 391

* 2.5 mm for 431 and 471

QUANTITY PER PACKING UNIT

Type	0402	0603	0805	1206	1210	1812	2220
Pcs/reel	10 000	4 000	3 000	3 000	2 000	1 000	1 000

DESIGN NOTE

Varistors do not have an endless lifetime. Also a well dimensioned varistor may fail due to enormous overload. This will result in heating, smoke emission and / or disposure of varistor itself. Therefore we recommend to place varistors separate within a box on PCB.

Furthermore a fuse should be in the varistor's current path to avoid secondary current in case the varistor fails. This fuse can protect against secondary currents and therewith caused damages.

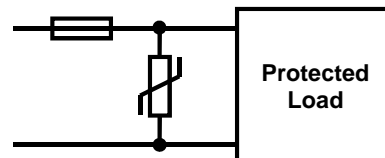

Würth Elektronik eiSos GmbH & Co.KG - Radialex department

D-74638 Waldenburg · Max-Eyth-Straße 1 - 3 · Germany · Telefon (+49) (0) 7942 - 945 - 0 · Telefax (+49) (0) 7942 - 945 - 400

<http://www.we-online.com>

Kunde / customer :

Artikelnummer / part number : **82533300**

Bezeichnung :

description : **HIGH SURGE 1210 SMD VARISTOR**

SMD size: **1210**

E Testbedingungen / test conditions :

BASIC TEST

Characteristics	Test Method/Description
Standard Test Condition	Environmental condition under which every measuring is done without doubt on the measuring results. Unless specially specified, temperature, relative humidity are 5 to 35°C, 45 to 85 % RH.
Max. Working Voltage	Maximum steady-state DC operating voltage the device can maintain and typical leakage current at 25°C not exceed 50 µA.
Varistor Voltage	With the specified measuring current of 1mA DC applied.
Max. Clamping Voltage	Maximum peak voltage across the varistor measured at a specified pulse current (A) and waveform 8/20µs.
Surge Current	Maximum peak current which may be applied with the specified waveform 8/20µs without device failure.
Surge Shift ΔV/V	The shift of varistor voltage after suffering the specified surge current.
Energy Absorption	Maximum energy which may be dissipated with a specified waveform 10/1000µs.without device failure.
Typical Capacitance	Device Capacitance measured with zero voltage bias 0.5VRMS and 1KHZ
Leakage Current	Typical leakage current at 25°C < 50µA

ENVIRONMENTAL RELIABILITY TEST

Characteristic	Test method and description															
High Temperature Storage	The specimen shall be subjected to 85 ± 2°C for 1000 ± 12 hours in a thermostatic bath without load and then stored at room temperature and humidity for 1 to 2 hours. The change of varistor voltage shall be within 10 % .															
Temperature Cycle	The temperature cycle of specified temperature shall be repeated five times and then stored at room temperature and humidity for one or two hours. the change of varistor voltage shall be within 10 % and mechanical damage shall be examined. <table border="1" style="margin-left: 20px;"> <thead> <tr> <th>Step</th> <th>Temperature</th> <th>Period</th> </tr> </thead> <tbody> <tr> <td>1</td> <td>-40±3°C</td> <td>30Min±3</td> </tr> <tr> <td>2</td> <td>Room Temperature</td> <td>1~2 hours</td> </tr> <tr> <td>3</td> <td>85±2°C</td> <td>30Min±3</td> </tr> <tr> <td>4</td> <td>Temperature</td> <td>1~2 hours</td> </tr> </tbody> </table>	Step	Temperature	Period	1	-40±3°C	30Min±3	2	Room Temperature	1~2 hours	3	85±2°C	30Min±3	4	Temperature	1~2 hours
Step	Temperature	Period														
1	-40±3°C	30Min±3														
2	Room Temperature	1~2 hours														
3	85±2°C	30Min±3														
4	Temperature	1~2 hours														
High Temperature Load	After being continuously applied the maximum allowable voltage at 85 ± 2°C for 1000± 2 hours, the specimen shall be stored at room temperature and humidity for one or two hours, the change of varistor voltage shall be within 10 % .															
Damp Heat Load/Humidity Load	The specimen should be subjected to 40 ± 2°C, 90 to 95 % RH environment , and the maximum allowable voltage applied for 1000 hours, then stored at room temperature and humidity for one or two hours. the change of varistor voltage shall be within 10 %															
Low Temperature Storage	The specimen should be subjected to 40 ± 2°C, without load for 1000 hours and then stored at room temperature for one or two hours. the change of varistor voltage shall be within 10 %															

Freigabe erteilt / general release:	Kunde / customer			
Datum / date	Unterschrift / signature			
	Würth Elektronik			
Geprüft / checked	2006-06-02	Kontrolliert / approved	JP. Penlou	
				J. BAIER Version 1 10-06-01
				Name Änderung / modification Datum / date

Würth Elektronik eiSos GmbH & Co.KG - Radialex department

D-74638 Waldenburg · Max-Eyth-Straße 1 - 3 · Germany · Telefon (+49) (0) 7942 - 945 - 0 · Telefax (+49) (0) 7942 - 945 - 400
<http://www.we-online.com>