

A Cubic, Single-pole 10-A Power Relay

- Subminiature “sugar cube” relay with universal terminal footprint.
- Conforms to VDE0435 (VDE approval: B250 Insulation grade), UL508, CSA22.2.
- Tracking resistance: CTI>250 (-VD type).
- UL class-F coil insulation model available (UL class-B coil insulation for standard model).
- High switching power: 10 A.
- Two types of seal available; flux protection and fully sealed.
- Withstands impulse of up to 4,500 V.
- 400-mW and 360-mW coil power consumption types available.
- Pre-soldered terminals.

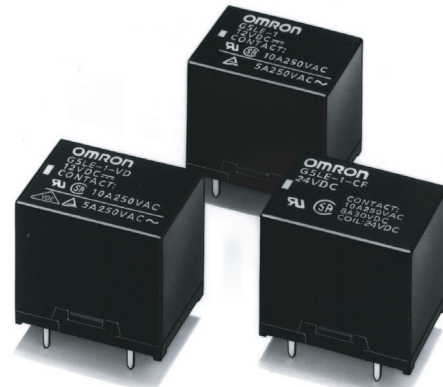

RoHS Compliant Refer to pages 16 to 17 for details.

Ordering Information

Enclosure ratings	Contact form	Contact material	
		AgSnO ₂	AgSnIn
Flux protection	SPDT	G5LE-1 G5LE-1-VD G5LE-1-CF	G5LE-1-ASI G5LE-1-ASI-VD G5LE-1-ASI-CF
	SPST-NO	G5LE-1A G5LE-1A-VD G5LE-1A-CF	G5LE-1A-ASI G5LE-1A-ASI-VD G5LE-1A-ASI-CF
Fully sealed	SPDT	G5LE-14 G5LE-14-VD G5LE-14-CF	G5LE-14-ASI G5LE-14-ASI-VD G5LE-14-ASI-CF
	SPST-NO	G5LE-1A4 G5LE-1A4-VD G5LE-1A4-CF	G5LE-1A4-ASI G5LE-1A4-ASI-VD G5LE-1A4-ASI-CF

Note: When ordering, add the rated coil voltage to the model number.

Example: G5LE-1 12 VDC

Rated coil voltage

Model Number Legend

G5LE - - - - VDC
 1 2 3 4 5 6 7 8

1. Number of Poles

1: 1 pole

2. Contact Form

None: SPDT

A: SPST-NO

3. Enclosure Ratings

None: Flux protection

4: Fully sealed

4. Contact Material

None: AgSnO₂

ASI: AgSnIn

5. Insulation System

None: Class B

CF: Class F (UL and CSA only)

6. Coil Power Consumption/Coil Characteristic

None: Approx. 400 mW

36: Approx. 360 mW

7. Approved Standards

None: UL, CSA, TÜV

VD: UL, CSA, TÜV and VDE

(Not applicable with “-CF”)

8. Rated Coil Voltage

5, 9, 12, 24, 48 VDC

Specifications

■ Coil Ratings

400-mW Type

Rated voltage	5 VDC	9 VDC	12 VDC	24 VDC	48 VDC
Rated current	79.4 mA	45 mA	33.3 mA	16.7 mA	8.33 mA
Coil resistance	63 Ω	200 Ω	360 Ω	1,440 Ω	5,760 Ω
Must operate voltage	75% max. of rated voltage				
Must release voltage	10% min. of rated voltage				
Max. voltage	170% of rated voltage at 23°C				
Power consumption	Approx. 400 mW				

Note: The rated current and coil resistance are measured at a coil temperature of 23°C with a tolerance of ±10%.

360-mW Type

Rated voltage	5 VDC	9 VDC	12 VDC	24 VDC	48 VDC
Rated current	72 mA	40 mA	30 mA	15 mA	7.5 mA
Coil resistance	70 Ω	225 Ω	400 Ω	1,600 Ω	6,400 Ω
Must operate voltage	75% max. of rated voltage				
Must release voltage	10% min. of rated voltage				
Max. voltage	170% of rated voltage (at 23°C)				
Power consumption	Approx. 360 mW				

Note: The rated current and coil resistance are measured at a coil temperature of 23°C with a tolerance of ±10%.

■ Contact Ratings

Load	Resistive load ($\cos\phi = 1$)
Rated load	10 A at 120 VAC; 8 A at 30 VDC
Rated carry current	10 A
Max. switching voltage	250 VAC, 125 VDC (30 VDC when UL/CSA standard is applied)
Max. switching current	AC: 10 A; DC: 8 A
Max. switching power	1,200 VA, 240 W
Failure rate (reference value)	100 mA at 5 VDC

Note: P level: $\lambda_{60} = 0.1 \times 10^{-6}$ operations

■ Characteristics

Contact resistance	100 mΩ max.
Operate time	10 ms max.
Release time	5 ms max.
Max. switching frequency	Mechanical: 18,000 operations/hr Electrical: 1,800 operations/hr at rated load
Insulation resistance	100 MΩ min. (at 500 VDC)
Dielectric strength	2,000 VAC, 50/60 Hz for 1 min between coil and contacts 750 VAC, 50/60 Hz for 1 min between contacts of same polarity
Impulse withstand voltage	4,500 V (1.2 50 μs) between coil and contacts
Vibration resistance	Destruction: 10 to 55 to 10 Hz, 0.75-mm single amplitude (1.5-mm double amplitude) Malfunction: 10 to 55 to 10 Hz, 0.75-mm single amplitude (1.5-mm double amplitude)
Shock resistance	Destruction: 1,000 m/s ² Malfunction: 100 m/s ²
Endurance	Mechanical: 10,000,000 operations min. (at 18,000 operations/hr) Electrical: 100,000 operations min. (at 1,800 operations/hr)
Ambient temperature	Operating: -25°C to 85°C (with no icing)
Ambient humidity	Operating: 5% to 85%
Weight	Approx. 12 g

■ Approved Standards

UL508, UL114, UL478, UL325, UL873, UL1409, UL1950 (File No. E41643)/CSA C22.2 No. 14, No. 1 (File No. LR34815)

Model	Coil rating	Contact rating
G5LE	3 to 48 VDC	12 A, 120 VAC (resistive load 30,000 cycles) 10 A, 250 VAC (general use) 10 A, 125 VAC (general use 100,000 cycles) 8 A, 30 VDC (resistive load) 6 A, 277 VAC (general use) NO: 1/6 hp, 120 VAC (50,000 cycles) 1/3 hp, 125 VAC, 70°C 30K with Class 130B system 65°C 30K with Class 105 Coil insulation system TV-3, 120 VAC TV-5, 120 VAC (For ASI only) NC: 1/8 hp, 120 VAC (50,000 cycles) 1/10 hp, 120 VAC (50,000 cycles)

TÜV DIN EN61810-1 (File No. J50030324)

Model	Coil rating	Contact rating
G5LE	Approx. 400 mW 3, 5, 6, 9, 12, 24 VDC Approx. 360 mW 5, 6, 9, 12, 24 VDC	2.5 A, 250 VAC ($\cos\phi = 0.4$) 5 A, 250 VAC (resistive load) 8 A, 30 VDC (resistive load)

VDE DIN EN61810-1, DIN EN60255 (File No. 6850ÜG)

Model	Coil rating	Contact rating
G5LE	Approx. 400 mW 3, 5, 6, 9, 12, 24, 48 VDC Approx. 360 mW 5, 6, 12, 24, 48 VDC	5 A, 250 VAC (resistive load, 50,000 cycles) at 85°C.

Engineering Data

Maximum Switching Power
G5LE

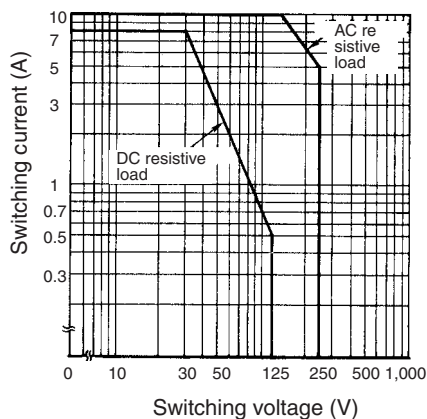

Endurance
G5LE

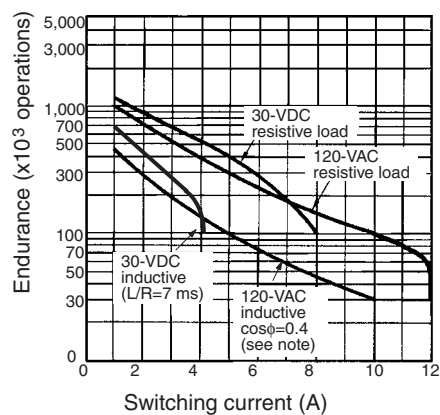

Note: Same curve as for 250-VAC resistive load

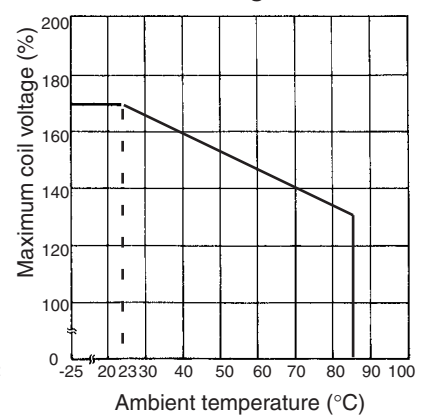

Ambient Temperature vs.
Maximum Coil Voltage



Note: The maximum coil voltage refers to the maximum value in a varying range of operating power voltage, not a continuous voltage.

Dimensions

Note: 1. All units are in millimeters unless otherwise indicated.

2. Orientation marks are indicated as follows:  

G5LE-1 G5LE-1A

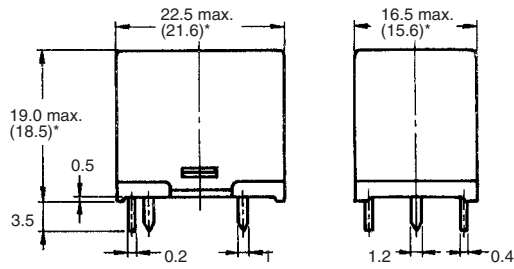
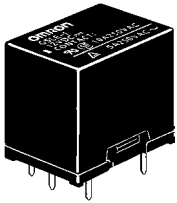

*Average value

Terminal Arrangement/Internal Connections (Bottom View)

SPDT

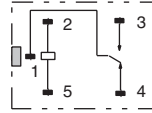

Mounting Holes (Bottom View)

Tolerance: ± 0.1 mm unless specified

SPDT

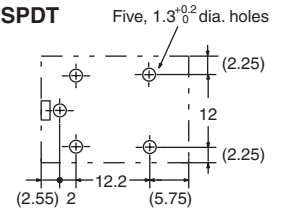

G5LE-14 G5LE-1A4

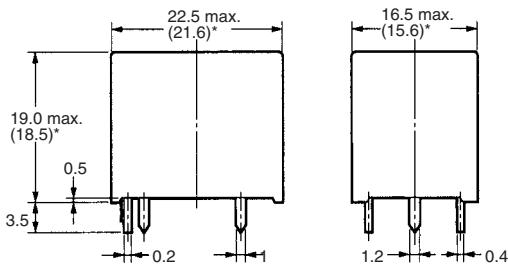
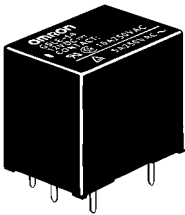

*Average value

Terminal Arrangement/Internal Connections (Bottom View)

SPST-NO

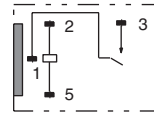

Mounting Holes (Bottom View)

Tolerance: ± 0.1 mm unless specified

SPST-NO

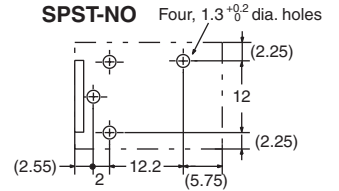

ALL DIMENSIONS SHOWN ARE IN MILLIMETERS.

To convert millimeters into inches, multiply by 0.03937. To convert grams into ounces, multiply by 0.03527.