

STANDARD RECOVERY DIODES

Stud Version

Features

- High surge current capability
- Avalanche types available
- Stud cathode and stud anode version
- Wide current range
- Types up to 1200V V_{RRM}

25 A

Typical Applications

- Battery charges
- Converters
- Power supplies
- Machine tool controls

Major Ratings and Characteristics

Parameters	25F(R)	Units
$I_{F(AV)}$	25	A
@ T_C	120	°C
$I_{F(RMS)}$	40	A
I_{FSM} @ 50Hz	356	A
@ 60Hz	373	A
I^2t @ 50Hz	636	A ² s
@ 60Hz	580	A ² s
V_{RRM} range	100 to 1200	V
T_J range	- 65 to 175	°C



ELECTRICAL SPECIFICATIONS

Voltage Ratings

Type number	Voltage Code	V _{RRM} : maximum repetitive peak reverse voltage V	V _{RSM} : maximum non-repetitive peak reverse voltage V	V _{R(BR)} : minimum avalanche voltage V (1)	I _{RRM} max. @ T _J = 175°C mA
25F(R)	10	100	150	--	12
	20	200	275	--	
	40	400	500	500	
	60	600	725	750	
	80	800	950	950	
	100	1000	1200	1150	
	120	1200	1400	1350	

(1) Avalanche version only available from V_{RRM} 400V to 1200V.

Forward Conduction

Parameter	25F(R)	Units	Conditions
I _{F(AV)} Max. average forward current @ Case temperature	25	A	180° conduction, half sine wave
	120	°C	
I _{F(RMS)} Max. RMS forward current	40	A	
P _R Maximum non-repetitive peak reverse power	10	K/W	10µs square pulse, T _J = T _J max. see note (2)
I _{FSM} Max. peak, one-cycle forward, non-repetitive surge current	356	A	t = 10ms No voltage
	373		t = 8.3ms reapplied
	300		t = 10ms 100% V _{RRM}
	314		t = 8.3ms reapplied
I ² t Maximum I ² t for fusing	636	A ² s	t = 10ms No voltage
	580		t = 8.3ms reapplied
	450		t = 10ms 100% V _{RRM}
	410		t = 8.3ms reapplied
I ² √t Maximum I ² √t for fusing	6360	A ² √s	t = 0.1 to 10ms, no voltage reapplied
	V _{F(TO)1} Low level value of threshold voltage	0.80	V
V _{F(TO)2} High level value of threshold voltage	0.90	(I > π × I _{F(AV)}), T _J = T _J max.	
r _{f1} Low level value of forward slope resistance	6.80	mΩ	(16.7% × π × I _{F(AV)}) < I < π × I _{F(AV)} , T _J = T _J max.
r _{f2} High level value of forward slope resistance	5.70		(I > π × I _{F(AV)}), T _J = T _J max.
V _{FM} Max. forward voltage drop	1.30	V	I _{pk} = 78A, T _J = 25°C, t _p = 400µs rectangular wave

(2) Available only for Avalanche version, all other parameters the same as 25F.

Thermal and Mechanical Specifications

Parameter	25F(R)	Units	Conditions
T _J Max. junction operating temperature range	-65 to 175	°C	
T _{stg} Max. storage temperature range	-65 to 200		
R _{thJC} Max. thermal resistance, junction to case	1.5	K/W	DC operation
R _{thCS} Max. thermal resistance, case to heatsink	0.5		Mounting surface, smooth, flat and greased
T Mounting torque, ± 10%	1.2 (1.5)	Nm	Lubricated threads (Not lubricated threads)
wt Approximate weight	7 (0.25)	g (oz)	
Case style	DO-203AA (DO-4)		See Outline Table

ΔR_{thJC} Conduction

(The following table shows the increment of thermal resistance R_{thJC} when devices operate at different conduction angles than DC)

Conduction angle	Sinusoidal conduction	Rectangular conduction	Units	Conditions
180°	0.28	0.24	K/W	T _J = T _J max.
120°	0.39	0.41		
90°	0.50	0.54		
60°	0.73	0.75		
30°	1.20	1.21		

Ordering Information Table

Device Code													
<table border="1" style="margin: auto;"> <tr> <td style="padding: 5px;">A</td> <td style="padding: 5px;">25</td> <td style="padding: 5px;">F</td> <td style="padding: 5px;">R</td> <td style="padding: 5px;">120</td> <td style="padding: 5px;">M</td> </tr> <tr> <td style="text-align: center;">①</td> <td style="text-align: center;">②</td> <td style="text-align: center;">③</td> <td style="text-align: center;">④</td> <td style="text-align: center;">⑤</td> <td style="text-align: center;">⑥</td> </tr> </table>	A	25	F	R	120	M	①	②	③	④	⑤	⑥	<p>1 - A = Avalanche diode None = Standard diode</p> <p>2 - Current rating: Code = I_{F(AV)}</p> <p>3 - F = Standard device</p> <p>4 - None = Stud Normal Polarity (Cathode to Stud) R = Stud Reverse Polarity (Anode to Stud)</p> <p>5 - Voltage code: Code x 10 = V_{RRM} (See Voltage Ratings table)</p> <p>6 - None = Stud base DO-203AA (DO-4) 10-32UNF-2A M = Stud base DO-203AA (DO-4) M5 X 0.8 - (Not available for Avalanche diodes)</p>
A	25	F	R	120	M								
①	②	③	④	⑤	⑥								

25F(R) Series

Bulletin I2018 rev. B 09/98

Outlines Table

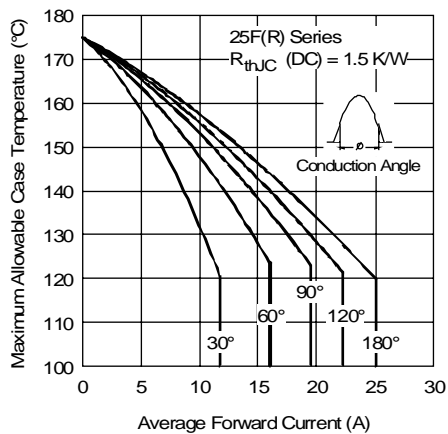
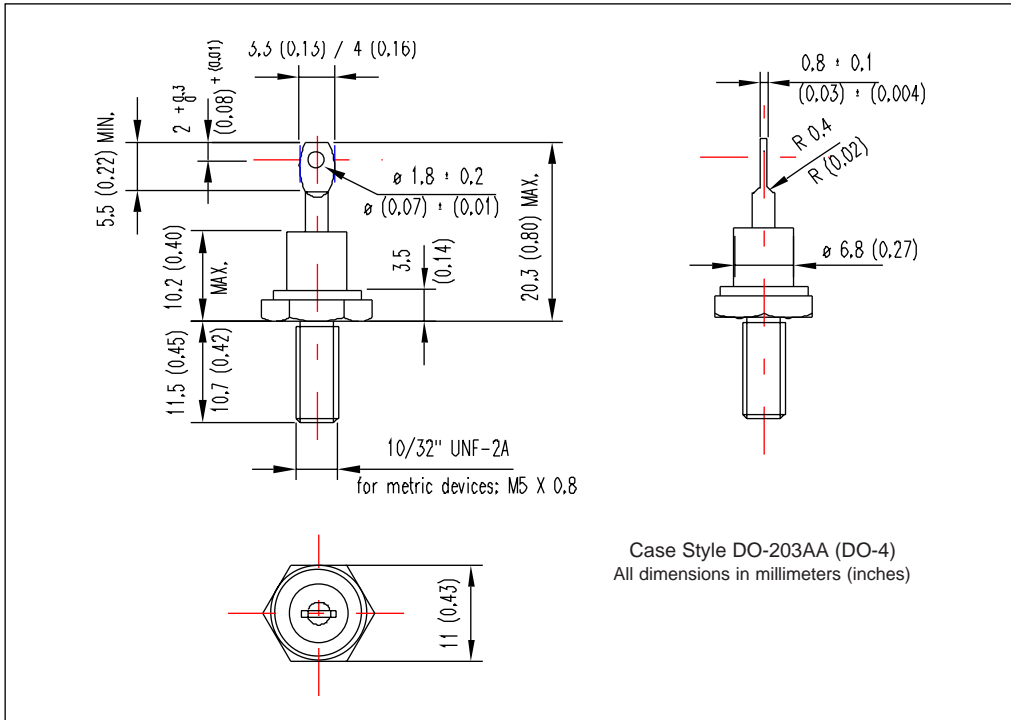

Fig. 1 - Current Ratings Characteristics

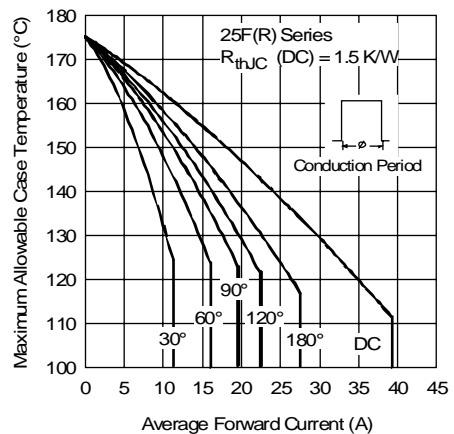

Fig. 2 - Current Ratings Characteristics

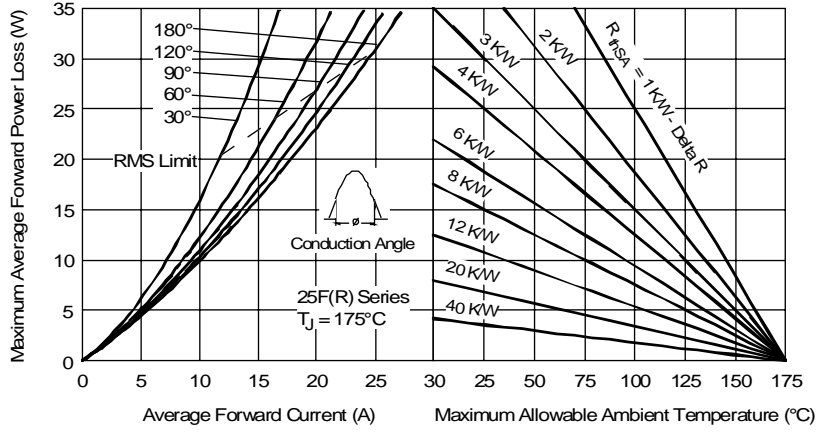

Fig. 3 - Forward Power Loss Characteristics

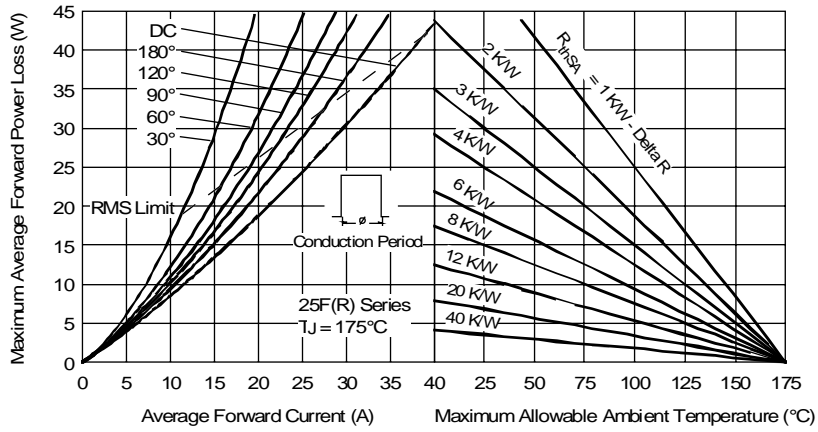

Fig. 4 - Forward Power Loss Characteristics

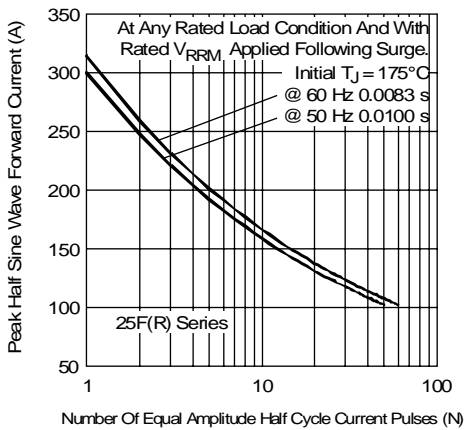

Fig. 5 - Maximum Non-Repetitive Surge Current

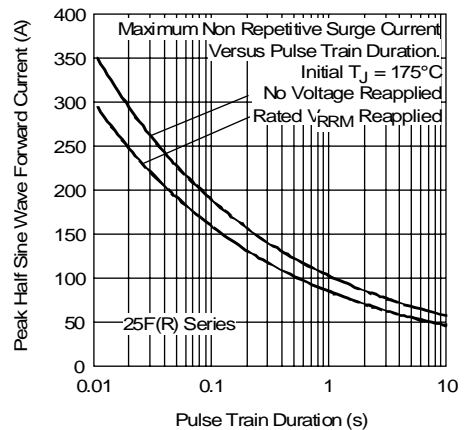

Fig. 6 - Maximum Non-Repetitive Surge Current

25F(R) Series

Bulletin I2018 rev. B 09/98

International
IR Rectifier

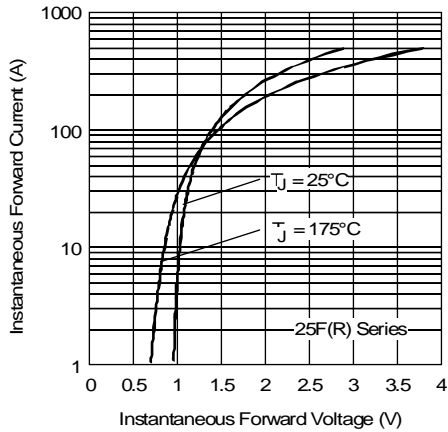

Fig. 7 - Forward Voltage Drop Characteristics

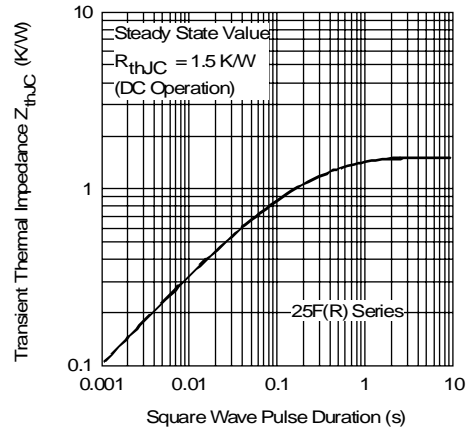

Fig. 8 - Thermal Impedance Z_{thJC} Characteristics

International
IR Rectifier

WORLDHEADQUARTERS: 233 Kansas St., El Segundo, California 90245 U.S.A. Tel: (310) 322 3331. Fax: (310) 322 3332.
EUROPEANHEADQUARTERS: Hurst Green, Oxted, Surrey RH8 9BB, U.K. Tel: ++ 44 1883 732020. Fax: ++ 44 1883 733408.

IR CANADA: 15 Lincoln Court, Brampton, Markham, Ontario L6T3Z2. Tel: (905) 453 2200. Fax: (905) 475 8801.

IR GERMANY: Saalburgstrasse 157, 61350 Bad Homburg. Tel: ++ 49 6172 96590. Fax: ++ 49 6172 965933.

IR ITALY: Via Liguria 49, 10071 Borgaro, Torino. Tel: ++ 39 11 4510111. Fax: ++ 39 11 4510220.

IR FAR EAST: K&H Bldg., 2F, 30-4 Nishi-Ikebukuro 3-Chome, Toshima-Ku, Tokyo, Japan 171. Tel: 81 3 3983 0086.

IR SOUTHEAST ASIA: 1 Kim Seng Promenade, Great World City West Tower, 13-11, Singapore 237994. Tel: ++ 65 838 4630.

IR TAIWAN: 16 Fl. Suite D.207, Sec. 2, Tun Haw South Road, Taipei, 10673, Taiwan. Tel: 886 2 2377 9936.

<http://www.irf.com>

Fax-On-Demand: +44 1883 733420

Data and specifications subject to change without notice.