



### FEATURES

- Low Cost
- Multiple Package Styles
- Internal Input and Output
- Filtering
- Non-Conductive Case
- High Output Power Density: 10 Watts/Inch<sup>3</sup>
- Extended Temperature Range: -25°C to +85°C
- Efficiency to 79%
- RoHS Compliant

The HPR1XXWC Series uses advanced circuit design and packaging technology to deliver superior reliability and performance. A 170kHz push-pull oscillator is used in the input stage. Beat-frequency oscillation problems are reduced when using the HPR1XXWC Series with high frequency isolation amplifiers.

Reduced parts count and high efficiency add to the reliability of the HPR1XXWC Series. The high efficiency of the HPR1XXWC Series means less internal power dissipation, as low as 190mW.

With reduced heat dissipation the HPR1XXWC Series can operate at higher temperatures with no degradation. In addition, the high efficiency of the HPR1XXWC Series means the series is able to offer greater than 10 W/Inch<sup>3</sup> of output power density. Operation down to no load will not impact the reliability of the series, although a >1mA minimum load is needed to realize published specifications.

The HPR1XXWC Series provides the user a low cost converter without sacrificing reliability. The use of surface mounted devices and advanced manufacturing technologies make it possible to offer premium performance and low cost.

All specifications are typical at TA = +25°C nominal input voltage unless otherwise specified.

### PRODUCT SELECTION CHART

MODEL	NOMINAL INPUT VOLTAGE (VDC)	RATED OUTPUT VOLTAGE (VDC)	RATED OUTPUT CURRENT (mA)	INPUT CURRENT		REFLECTED RIPPLE CURRENT (mAp-p)	EFFICIENCY (%)
				NO LOAD (mA)	RATED LOAD (mA)		
HPR100WC	5	5	150	20	216	10	69
-HPR101WC	5	12	62	20	212	5	70
-HPR102WC	5	15	50	20	212	5	71
-HPR103WC	5	±5	±75	20	218	5	68
-HPR104WC	5	±12	±30	20	212	5	68
HPR105WC	5	±15	±25	20	200	5	75
-HPR106WC	12	5	150	10	90	5	69
-HPR107WC	12	12	62	10	81	5	77
-HPR108WC	12	15	50	10	81	5	77
HPR109WC	12	±5	±75	10	88	5	71
-HPR110WC	12	±12	±30	10	81	5	74
-HPR111WC	12	±15	±25	10	81	5	77
-HPR112WC	15	5	150	8	72	5	69
-HPR113WC	15	12	62	8	72	5	69
-HPR114WC	15	15	50	8	72	5	69
-HPR115WC	15	±5	±75	8	72	5	69
-HPR116WC	15	±12	±30	8	63	5	76
-HPR117WC	15	±15	±25	8	63	5	79
-HPR118WC	24	5	150	8	48	15	65
-HPR119WC	24	12	62	8	48	15	65
-HPR120WC	24	15	50	8	45	15	76
-HPR121WC	24	±5	±75	8	45	15	69
-HPR122WC	24	±12	±30	8	45	15	67
-HPR123WC	24	±15	±25	8	45	15	69

Note: Other input to output voltages may be available. Please contact Murata Power Solutions.



For full details go to [www.murata-ps.com/rohs](http://www.murata-ps.com/rohs)

### SPECIFICATIONS, ALL MODELS

Specifications are at  $T_A = +25^\circ\text{C}$  nominal input voltage unless otherwise specified.

PARAMETER		CONDITIONS	MIN	TYP	MAX	UNITS	
OUTPUT	<b>INPUT</b>						
	Voltage Range		4.5	5	5.5	VDC	
			10.8	12	13.2	VDC	
			13.5	15	16.5	VDC	
			21.6	24	26.4	VDC	
	Voltage Rise Time See Typical Performance Curves & Application Notes: "Capacitive Loading Effects on Start-Up of DC/DC Converters"						
	<b>OUTPUT</b>						
	Rated Power				750	mW	
	Voltage Setpoint Accuracy	Rated Load, Nominal $V_{IN}$			$\pm 5$	%	
	Ripple & Noise	BW = DC to 10MHz			150	mVp-p	
BW = 10Hz to 2MHz				30	mVrms		
Voltage (Over Input Voltage Range)	1mA to Rated Current, $V_{OUT} = 5V$		4.75		7	VDC	
	1mA to Rated Current, $V_{OUT} = 12V$		11.40		15	VDC	
	1mA to Rated Current, $V_{OUT} = 15V$		14.25		18	VDC	
Temperature Coefficient			.01		.05	%/°C	
<b>REGULATION</b>							
Load Regulation (All other modes)	Rated Load to 1mA Load			3		%	
<b>GENERAL ISOLATION</b>							
Rated Voltage			750			VDC	
Test Voltage	60 Hz, 10 Seconds		750			Vrms	
Resistance			10			GΩ	
Capacitance				25	100	pF	
Leakage Current	$V_{ISO} = 240\text{VAC}, 60\text{Hz}$			2	8.5	μArms	
Switching Frequency				170		kHz	
Frequency Change	Over Line and Load			24		%	
Package Weight					3	g	
MTTF per MIL-HDBK-217, Rev. F*	Circuit Stress Method						
Ground Benign	$T_A = +25^\circ\text{C}$		7.9			MHr	
Fixed Ground	$T_A = +35^\circ\text{C}$		1.9			MHr	
Naval Sheltered	$T_A = +35^\circ\text{C}$		1.2			MHr	
Airborne Uninhabited Fighter	$T_A = +35^\circ\text{C}$		300			kHr	
Moisture Sensitivity Level (MSL)	IPC/JEDEC J-STD-20			2			
<b>TEMPERATURE</b>							
Specification			-25	+25	+85	°C	
Operation			-40		+100	°C	
Storage			-40		+110	°C	

### SOLDERING INFORMATION

The surface mount versions of the HPR1XXWC series are designed for SMT reflow soldering. During this standard process devices should be heated at a rate not to exceed 3 degrees C per second. The peak reflow temperature is 260 degrees C. The device should not be exposed to the peak temperature  $\pm 10$  degrees C for more than 12 seconds. The cool down rate for this device should not exceed 3 degrees C per second.

**TYPICAL PERFORMANCE CURVES**

Specifications are at  $T_A = +25^\circ\text{C}$  nominal input voltage and nominal load.

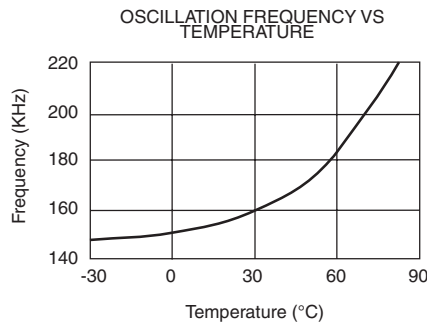
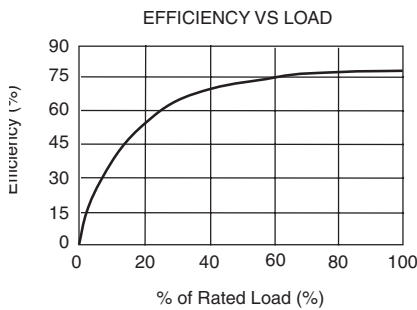
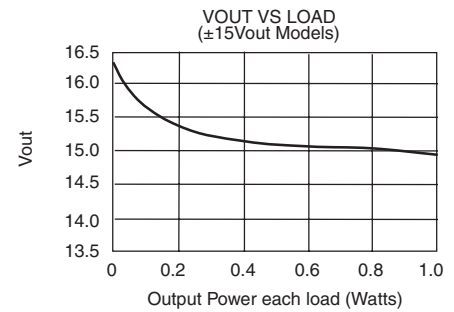
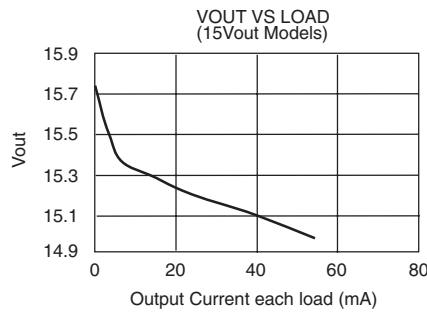
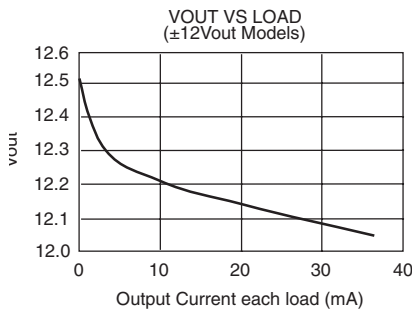
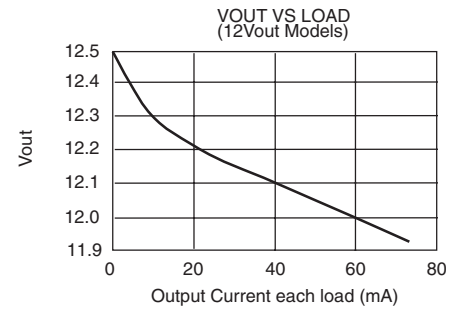
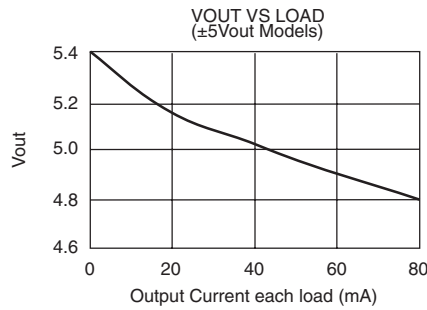
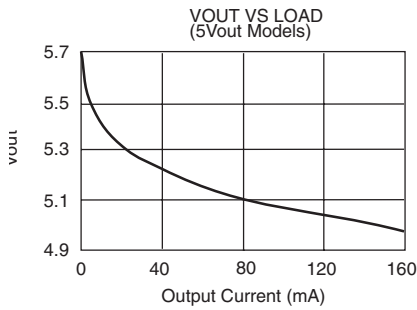

**SAFE OPERATING AREA**

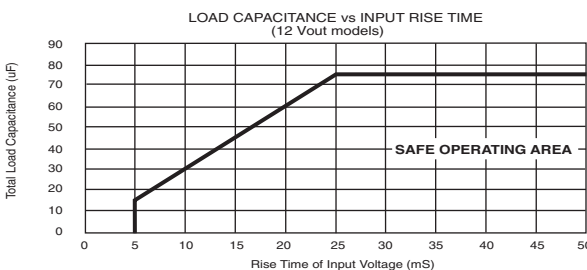
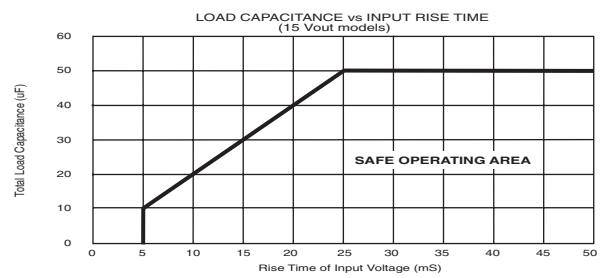
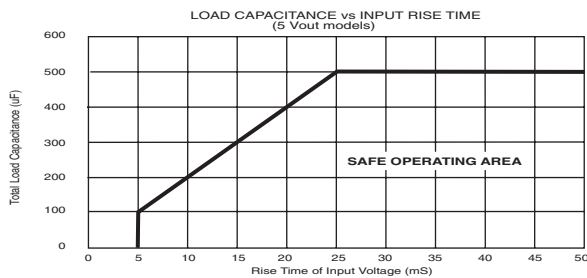

**NOTES:**

- 1.) When operated within the SAFE OPERATING AREA as defined by the above curves, the output voltage of HPR1XXC devices is guaranteed to be within 95% of its steady-state value within 100 milliseconds after the input voltage has reached 95% of its steady-state value.
- 2.) For dual output models, total load capacitance is the sum of the capacitances on the plus and minus outputs.

**MECHANICAL**

**PACKAGE/PINOUT "W"**

**SMD PACKAGE**

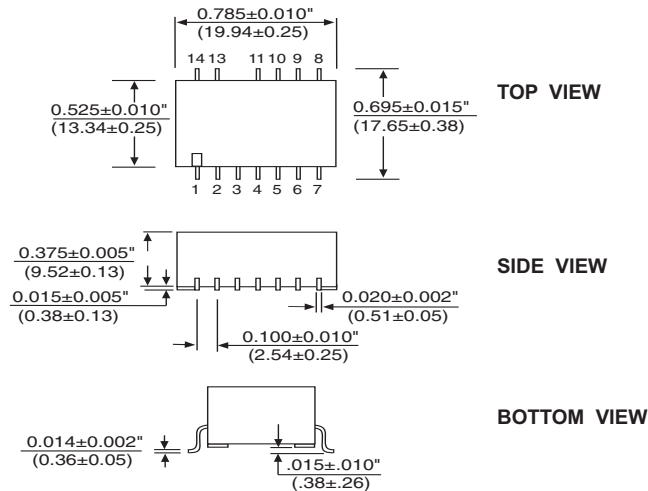

PIN CONNECTIONS					
PIN#	SINGLES	DUALS	PIN#	SINGLES	DUALS
1	+VIN	+VIN	7	+VOUT	+VOUT
2	-VIN	-VIN	8	NC	NC
3	NC	NC	9	NC	NC
4	NC	NC	10	NC	NC
5	-VOUT	-VOUT	11	NC	NC
6	NC	Common	13	NC	NC
			14	NC	NC

**NOTES:**  
 NC = Do Not Connect.  
 Duplicate pin functions are internally connected.  
 All dimensions are in inches (millimeters).  
 GRID: 0.100 inches (2.54 millimeters)  
 MATERIAL: Lead material is phosphor bronze; lead finish is 100-300 microinches of matte tin over a nickel barrier layer of 5-40 microinches.

ABSOLUTE MAXIMUM RATINGS	
Internal Power Dissipation .....	450mW
Short Circuit Duration.....	Momentary

ORDERING INFORMATION	
Device Family	HPR 1XX W C
HPR Indicates DC/DC Converter	
Model Number	Selected from Table of Electrical Characteristics
Package Option	W = SMD Package
RoHS Compliant Version	

Murata Power Solutions, Inc.  
 11 Cabot Boulevard, Mansfield, MA 02048-1151 U.S.A.  
 Tel: (508) 339-3000 (800) 233-2765 Fax: (508) 339-6356  
**www.murata-ps.com email: sales@murata-ps.com ISO 9001 REGISTERED**

Murata Power Solutions, Inc. makes no representation that the use of its products in the circuits described herein, or the use of other technical information contained herein, will not infringe upon existing or future patent rights. The descriptions contained herein do not imply the granting of licenses to make, use, or sell equipment constructed in accordance therewith. Specifications are subject to change without notice.  
 © 2008 Murata Power Solutions, Inc.  
 05/09/08

**USA:** Mansfield (MA), Tel: (508) 339-3000, email: sales@murata-ps.com  
**Canada:** Toronto, Tel: (866) 740-1232, email: toronto@murata-ps.com  
**UK:** Milton Keynes, Tel: +44 (0)1908 615232, email: mk@murata-ps.com  
**France:** Montigny Le Bretonneux, Tel: +33 (0)1 34 60 01 01, email: france@murata-ps.com  
**Germany:** München, Tel: +49 (0)89-544334-0, email: munich@murata-ps.com  
**Japan:** Tokyo, Tel: 3-3779-1031, email: sales\_tokyo@murata-ps.com  
 Osaka, Tel: 6-6354-2025, email: sales\_osaka@murata-ps.com  
**Website: www.murata-ps.jp**  
**China:** Shanghai, Tel: +86 215 027 3678, email: shanghai@murata-ps.com  
 Guangzhou, Tel: +86 208 221 8066, email: guangzhou@murata-ps.com