

# Spezifikation für Freigabe / specification for release

Kunde / customer :

Artikelnummer / part number : **744324033**

LF



Bezeichnung : **SPEICHERDROSSEL WE-HC**

description : **POWER-CHOKE WE-HC**

**WÜRTH ELEKTRONIK**

DATUM / DATE : 2006-06-02

## A Mechanische Abmessungen / dimensions :

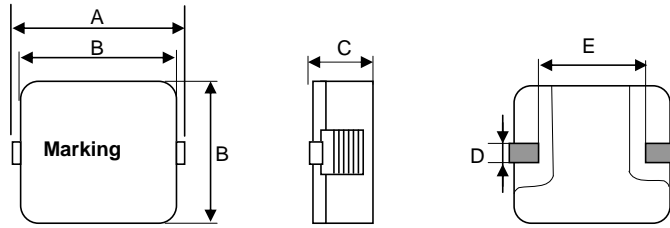

A	<b>10,5 ± 0,5</b>	mm
B	<b>10,0 ± 0,4</b>	mm
C	<b>3,9 ± 0,2</b>	mm
D	<b>2,35 ref.</b>	mm
E	<b>5,6 ref.</b>	mm
F		mm
G		mm
H		mm

## B Elektrische Eigenschaften / electrical properties :

Eigenschaften / properties	Testbedingungen / test conditions		Wert / value	Einheit / unit	tol.
Induktivität / inductance	<b>100 kHz / 0,1V</b>	$L_o$	<b>0,39</b>	$\mu\text{H}$	$\pm 20\%$
Nenn-Induktivität / rated inductance	<b>100 kHz / 0,1V / 22A</b>	$L_N$	<b>0,30</b>	$\mu\text{H}$	$\pm 20\%$
DC-Widerstand / DC-resistance	<b>@ 20° C</b>	$R_{DC \text{ typ}}$	<b>1,36</b>	$\text{m}\Omega$	<b>typ.</b>
DC-Widerstand / DC-resistance	<b>@ 20° C</b>	$R_{DC \text{ max}}$	<b>1,86</b>	$\text{m}\Omega$	<b>max.</b>
Nennstrom / rated current	<b><math>\Delta T = 50 \text{ K}</math></b>	$I_{DC}$	<b>22,0</b>	A	<b>typ.</b>
Sättigungsstrom / saturation current	<b><math>\Delta L/L_o = -30\%</math></b>	$I_{\text{sat}}$	<b>56,0</b>	A	<b>typ.</b>
Eigenres.-Frequenz / self.res.-frequency		SRF	<b>174,0</b>	MHz	<b>ref.</b>

## C Lötpad / soldering spec. :

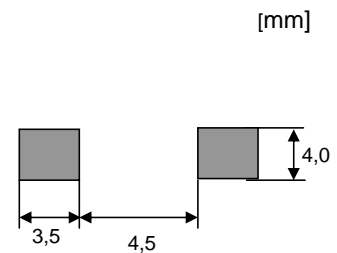

## D Prüfgeräte / test equipment :

HP 4274 A für/for L und/and Q  
HP 34401 A für/for  $I_{DC}$  und/and  $R_{DC}$

## E Testbedingungen / test conditions :

Luftfeuchtigkeit / humidity: 33%  
Umgebungstemperatur / temperature: + 25°C

## F Werkstoffe & Zulassungen / material & approvals :

Kernmaterial / core material: WE-Superflux 200  
Draht / wire: Flatwire/ Flachdraht UL94-V0; 2UEWF 155°C

## G Eigenschaften / granted properties :

Arbeitstemperatur / operating temperature: -40°C - +150°C  
Umgebungstemp. / ambient temperature: -40°C - +100°C  
It is recommended that the temperature of the part does not exceed 150°C under worst case operating conditions.

Freigabe erteilt / general release:	Kunde / customer			
Datum / date	Unterschrift / signature		RST	Version 5
			ME	Version 4
	Würth Elektronik		MST	Version 3
			SST	Version 2
			JH	Version 1
Geprüft / checked	Kontrolliert / approved		Name	Änderung / modification
				Datum / date

**Würth Elektronik eiSos GmbH & Co. KG**

D-74638 Waldenburg · Max-Eyth-Strasse 1 - 3 · Germany · Telefon (+49) (0) 7942 - 945 - 0 · Telefax (+49) (0) 7942 - 945 - 400  
<http://www.we-online.com>

# Spezifikation für Freigabe / specification for release

Kunde / customer :

Artikelnummer / part number : **744324033**

LF



Bezeichnung : **SPEICHERDROSSEL WE-HC**

description : **POWER-CHOKE WE-HC**

DATUM / DATE : 2006-06-02

## H Induktivitätskurve / Inductance curve :

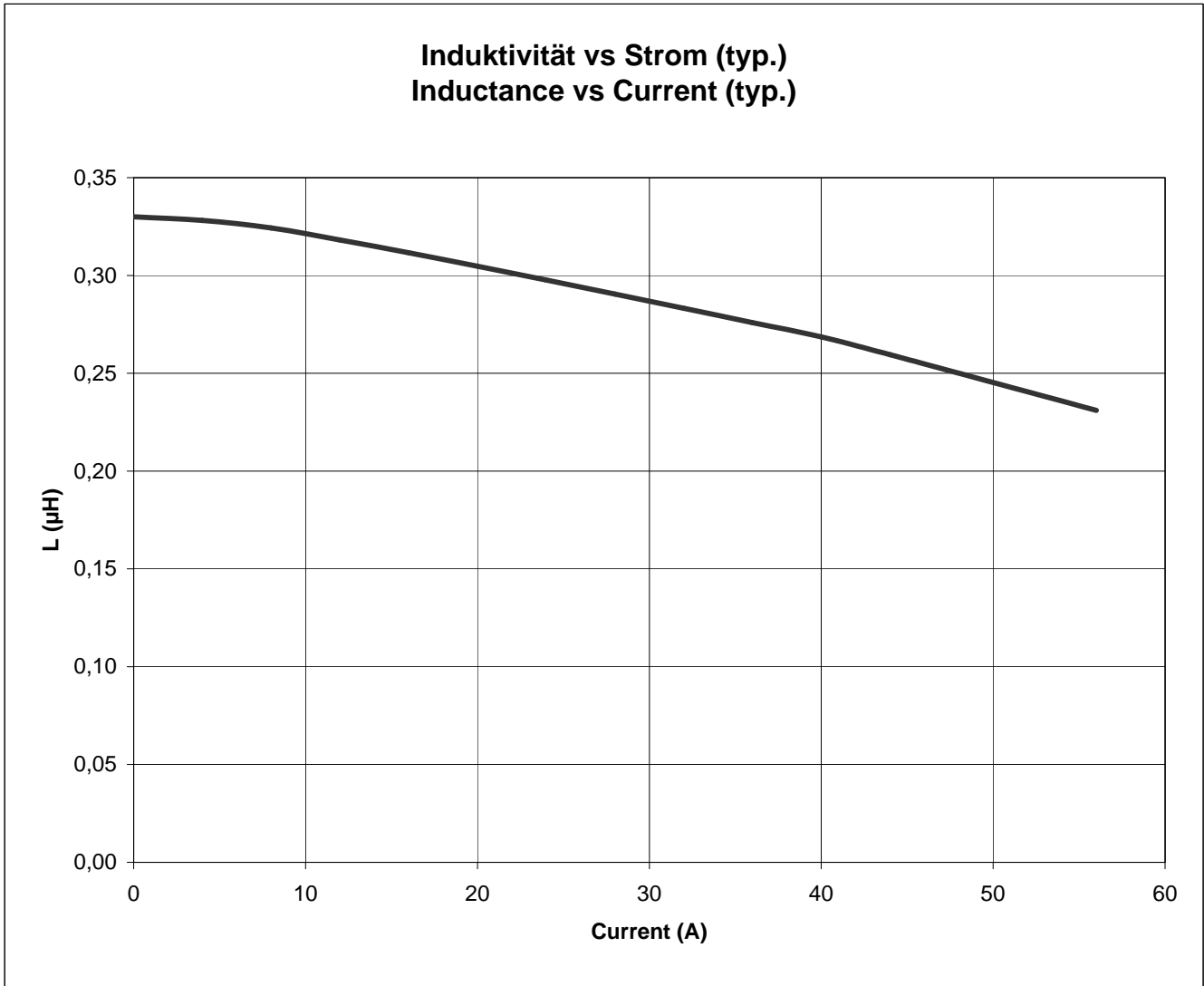

Freigabe erteilt / general release:	<b>Kunde / customer</b>			
Datum / date	Unterschrift / signature	RST	Version 5	2006-06-02
	<b>Würth Elektronik</b>	ME	Version 4	2005-04-18
Geprüft / checked	Kontrolliert / approved	MST	Version 3	2004-10-11
		SST	Version 2	2004-02-02
		JH	Version 1	2000-12-06
		Name	Änderung / modification	Datum / date

**Würth Elektronik eiSos GmbH & Co. KG**

D-74638 Waldenburg · Max-Eyth-Strasse 1 - 3 · Germany · Telefon (+49) (0) 7942 - 945 - 0 · Telefax (+49) (0) 7942 - 945 - 400  
<http://www.we-online.com>

# Spezifikation für Freigabe / specification for release

Kunde / customer :  
 Artikelnummer / part number :  
 Bezeichnung :  
 description :

**744324033**

LF



**WÜRTH ELEKTRONIK**

**DATUM / DATE : 2006-06-02**

**I Temperaturanstieg / Temperature rise curve :**

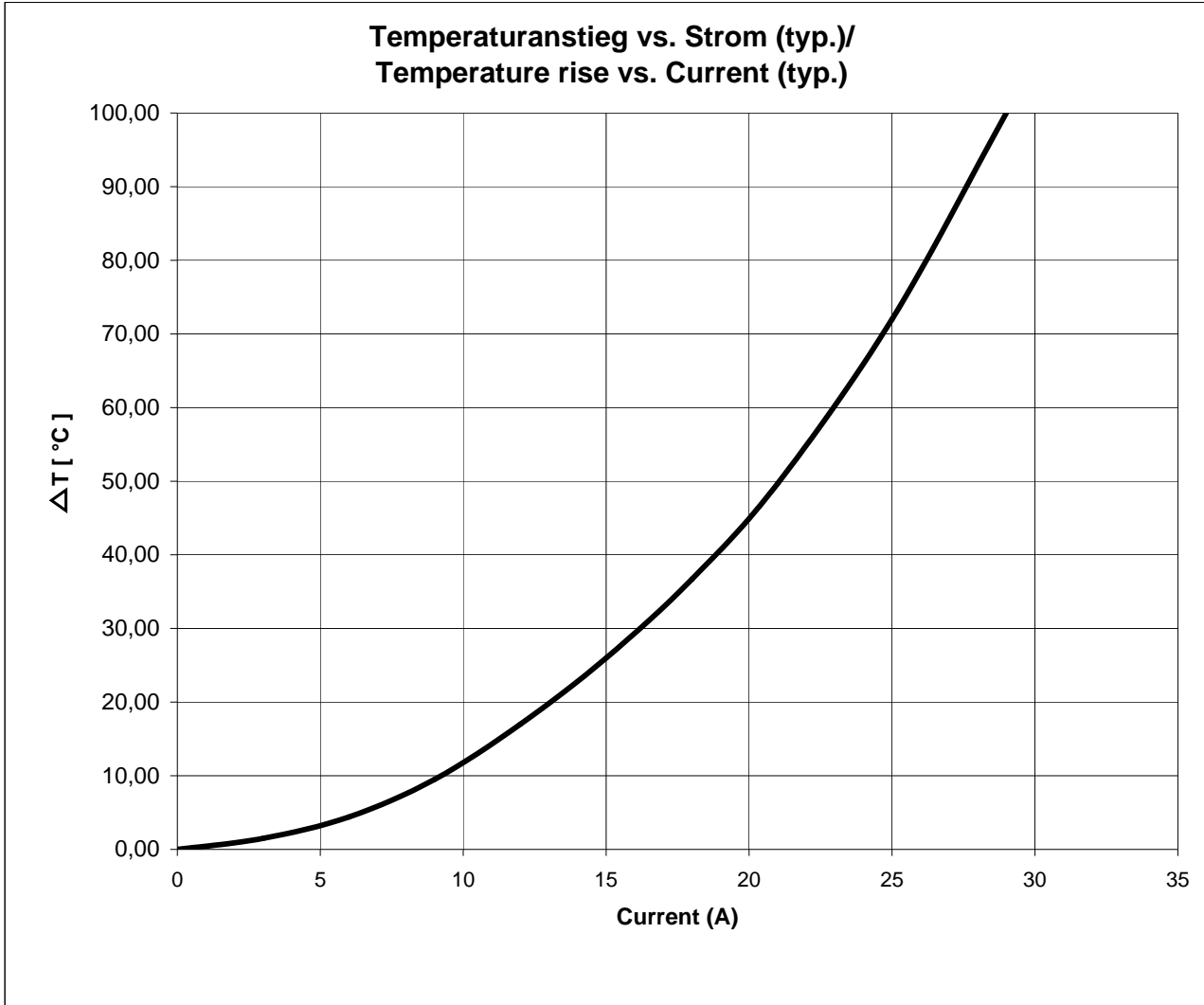

Freigabe erteilt / general release:	<b>Kunde / customer</b>			
Datum / date	Unterschrift / signature	RST	Version 5	2006-06-02
	<b>Würth Elektronik</b>	ME	Version 4	2005-04-18
Geprüft / checked	Kontrolliert / approved	MST	Version 3	2004-10-11
		SST	Version 2	2004-02-02
		JH	Version 1	2000-12-06
		Name	Änderung / modification	Datum / date

**Würth Elektronik eiSos GmbH & Co. KG**

D-74638 Waldenburg · Max-Eyth-Strasse 1 - 3 · Germany · Telefon (+49) (0) 7942 - 945 - 0 · Telefax (+49) (0) 7942 - 945 - 400  
<http://www.we-online.com>

# Spezifikation für Freigabe / specification for release

Kunde / customer :  
 Artikelnummer / part number : **744324033**  
 Bezeichnung : **SPEICHERDROSSEL WE-HC**  
 description : **POWER-CHOKE WE-HC**

LF



DATUM / DATE : 2006-06-02

## J Rollenspezifikation / tape and reel specification :

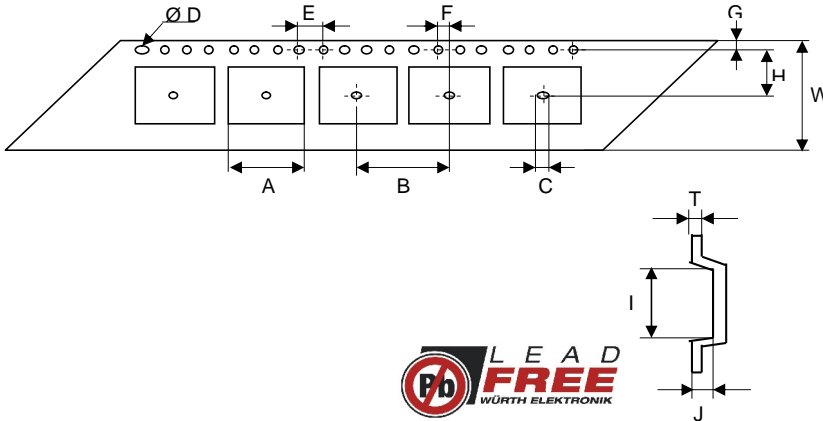

Gurtspezifikation / Tape specification:		
A	<b>10,85 ± 0,1</b>	mm
B	<b>16,0 ± 0,1</b>	mm
C	<b>1,50<sup>+0,1</sup><sub>-0,0</sub></b>	mm
D	<b>1,50<sup>+0,1</sup><sub>-0,0</sub></b>	mm
E	<b>4,00 ± 0,1</b>	mm
F	<b>2,00 ± 0,1</b>	mm
G	<b>1,75 ± 0,1</b>	mm
H	<b>11,5 ± 0,1</b>	mm
I	<b>11,65 ± 0,1</b>	mm
J	<b>4,30 ± 0,1</b>	mm
T	<b>0,35 ± 0,05</b>	mm
W	<b>24,0 ± 0,3</b>	mm

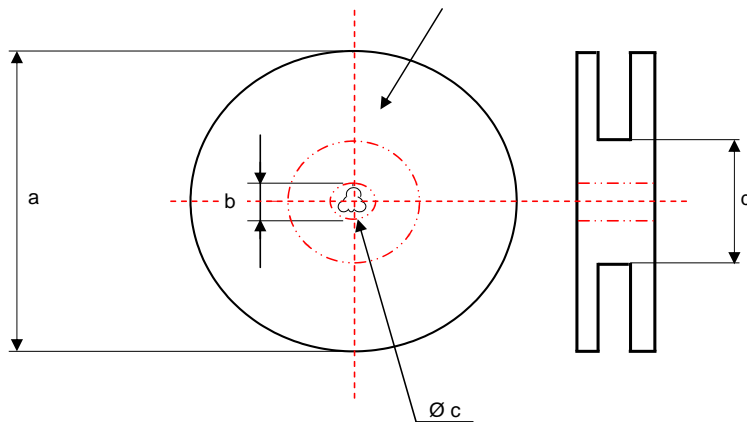

Rollenspezifikation / Reel specification:		
a	<b>330,0 ± 0,5</b>	mm
b	<b>20,20 ± 0,1</b>	mm
c	<b>13,00<sup>+0,5</sup><sub>-1,0</sub></b>	mm
d	<b>100,0 ± 1,0</b>	mm

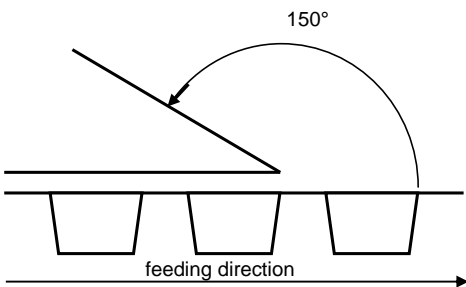

The Force for tearing off cover tape is 20 to 70 grams in arrow direction

Freigabe erteilt / general release:	Kunde / customer		
	Datum / date	Unterschrift / signature	
Geprüft / checked	Würth Elektronik	RST	Version 5 06-06-02
		ME	Version 4 05-04-18
Kontrolliert / approved		MST	Version 3 04-10-11
		SST	Version 2 04-02-02
		JH	Version 1 00-12-06
		Name	Änderung / modification Datum / date

This electronic component has been designed and developed for usage in general electronic equipment. Before incorporating this component into any equipment where higher safety and reliability is especially required or if there is the possibility of direct damage or injury to human body, for example in the range of aerospace, aviation, nuclear control, submarine, transportation, (automotive control, train control, ship control), transportation signal, disaster prevention, medical, public information network etc, Würth Elektronik eiSos GmbH must be informed before the design-in stage. In addition, sufficient reliability evaluation checks for safety must be performed on every electronic component which is used in electrical circuits that require high safety and reliability functions or performance.

**Würth Elektronik eiSos GmbH & Co. KG**

D-74638 Waldenburg · Max-Eyth-Strasse 1 - 3 · Germany · Telefon (+49) (0) 7942 - 945 - 0 · Telefax (+49) (0) 7942 - 945 - 400  
<http://www.we-online.com>