

Spezifikation für Freigabe / specification for release

Kunde / customer :

Artikelnummer / part number : **744324100**

LF



Bezeichnung : **SPEICHERDROSSEL WE-HC**
 description : **POWER-CHOKE WE-HC**

WÜRTH ELEKTRONIK

DATUM / DATE : 2006-06-02

A Mechanische Abmessungen / dimensions :

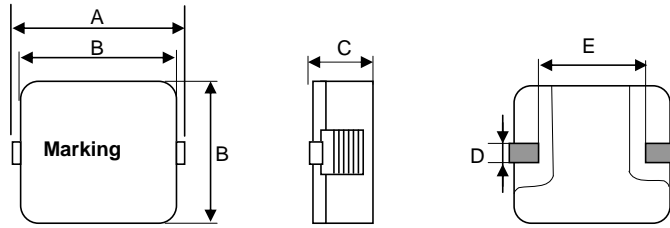

A	10,5 ± 0,5	mm
B	10,0 ± 0,4	mm
C	3,9 ± 0,2	mm
D	2,35 ref.	mm
E	5,6 ref.	mm
F		mm
G		mm
H		mm

B Elektrische Eigenschaften / electrical properties :

Eigenschaften / properties	Testbedingungen / test conditions		Wert / value	Einheit / unit	tol.
Induktivität / inductance	100 kHz / 0,1V	L_o	1,20	μH	$\pm 20\%$
Nenn-Induktivität / rated inductance	100 kHz / 0,1V / 14A	L_N	1,00	μH	$\pm 20\%$
DC-Widerstand / DC-resistance	@ 20° C	$R_{DC \text{ typ}}$	4,48	$\text{m}\Omega$	typ.
DC-Widerstand / DC-resistance	@ 20° C	$R_{DC \text{ max}}$	5,30	$\text{m}\Omega$	max.
Nennstrom / rated current	$\Delta T = 50 \text{ K}$	I_{DC}	14,0	A	typ.
Sättigungsstrom / saturation current	$\Delta L/L_o = -30\%$	I_{sat}	24,0	A	typ.
Eigenres.-Frequenz / self.res.-frequency		SRF	77,0	MHz	ref.

C Lötpad / soldering spec. :

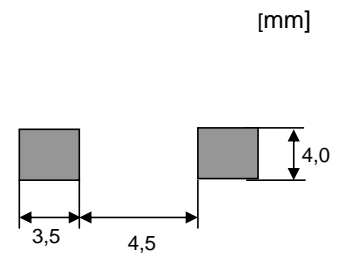

D Prüfgeräte / test equipment :

HP 4274 A für/for L und/and Q
HP 34401 A für/for I_{DC} und/and R_{DC}

E Testbedingungen / test conditions :

Luftfeuchtigkeit / humidity: 33%
 Umgebungstemperatur / temperature: + 25°C

F Werkstoffe & Zulassungen / material & approvals :

Kernmaterial / core material: WE-Superflux 200
 Draht / wire: Flatwire/ Flachdraht UL94-V0; 2UEWF 155°C

G Eigenschaften / granted properties :

Arbeitstemperatur / operating temperature: -40°C - +150°C
 Umgebungstemp. / ambient temperature: -40°C - +100°C
 It is recommended that the temperature of the part does not exceed 150°C under worst case operating conditions.

Freigabe erteilt / general release:	Kunde / customer			
Datum / date	Unterschrift / signature			
	Würth Elektronik			
Geprüft / checked	Kontrolliert / approved		Name	Änderung / modification
			RST	Version 5
			ME	Version 4
			MST	Version 3
			SST	Version 2
			JH	Version 1
				2006-06-02
				2005-04-18
				2004-10-11
				2004-02-02
				2000-12-06

Würth Elektronik eiSos GmbH & Co. KG

D-74638 Waldenburg · Max-Eyth-Strasse 1 - 3 · Germany · Telefon (+49) (0) 7942 - 945 - 0 · Telefax (+49) (0) 7942 - 945 - 400
<http://www.we-online.com>

Spezifikation für Freigabe / specification for release

Kunde / customer :
 Artikelnummer / part number : **744324100**
 Bezeichnung : **SPEICHERDROSSEL WE-HC**
 description : **POWER-CHOKE WE-HC**

LF



DATUM / DATE : 2006-06-02

H Induktivitätskurve / Inductance curve :

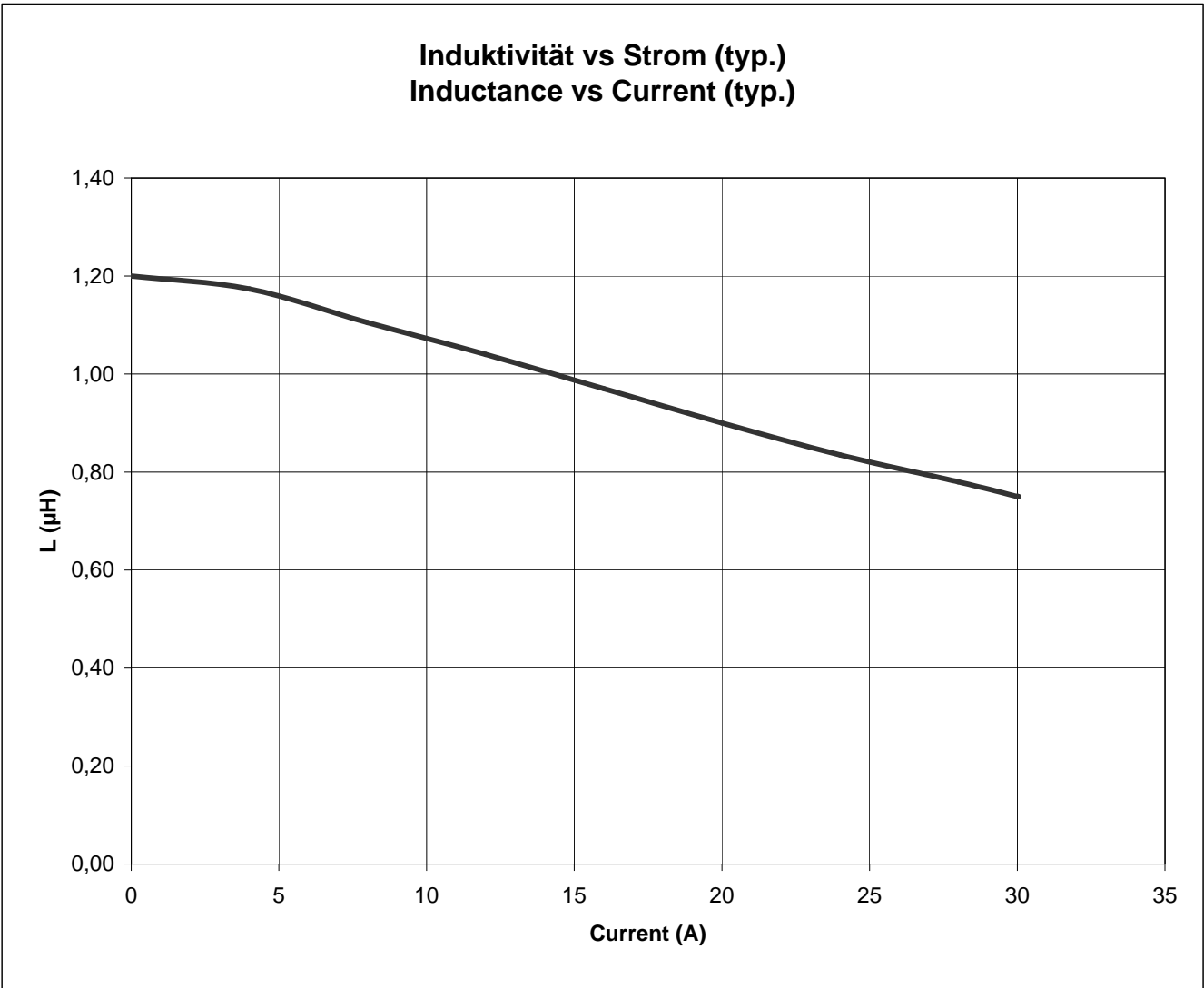

Freigabe erteilt / general release:	Kunde / customer			
.....	RST	Version 5	2006-06-02
Datum / date	Unterschrift / signature	ME	Version 4	2005-04-18
.....	MST	Version 3	2004-10-11
	Würth Elektronik	SST	Version 2	2004-02-02
.....	JH	Version 1	2000-12-06
Geprüft / checked	Kontrolliert / approved	Name	Änderung / modification	Datum / date

Würth Elektronik eiSos GmbH & Co. KG

D-74638 Waldenburg · Max-Eyth-Strasse 1 - 3 · Germany · Telefon (+49) (0) 7942 - 945 - 0 · Telefax (+49) (0) 7942 - 945 - 400
<http://www.we-online.com>

Spezifikation für Freigabe / specification for release

Kunde / customer :
 Artikelnummer / part number :
 Bezeichnung :
 description :

744324100

LF



WÜRTH ELEKTRONIK

DATUM / DATE : 2006-06-02

I Temperaturanstieg / Temperature rise curve :

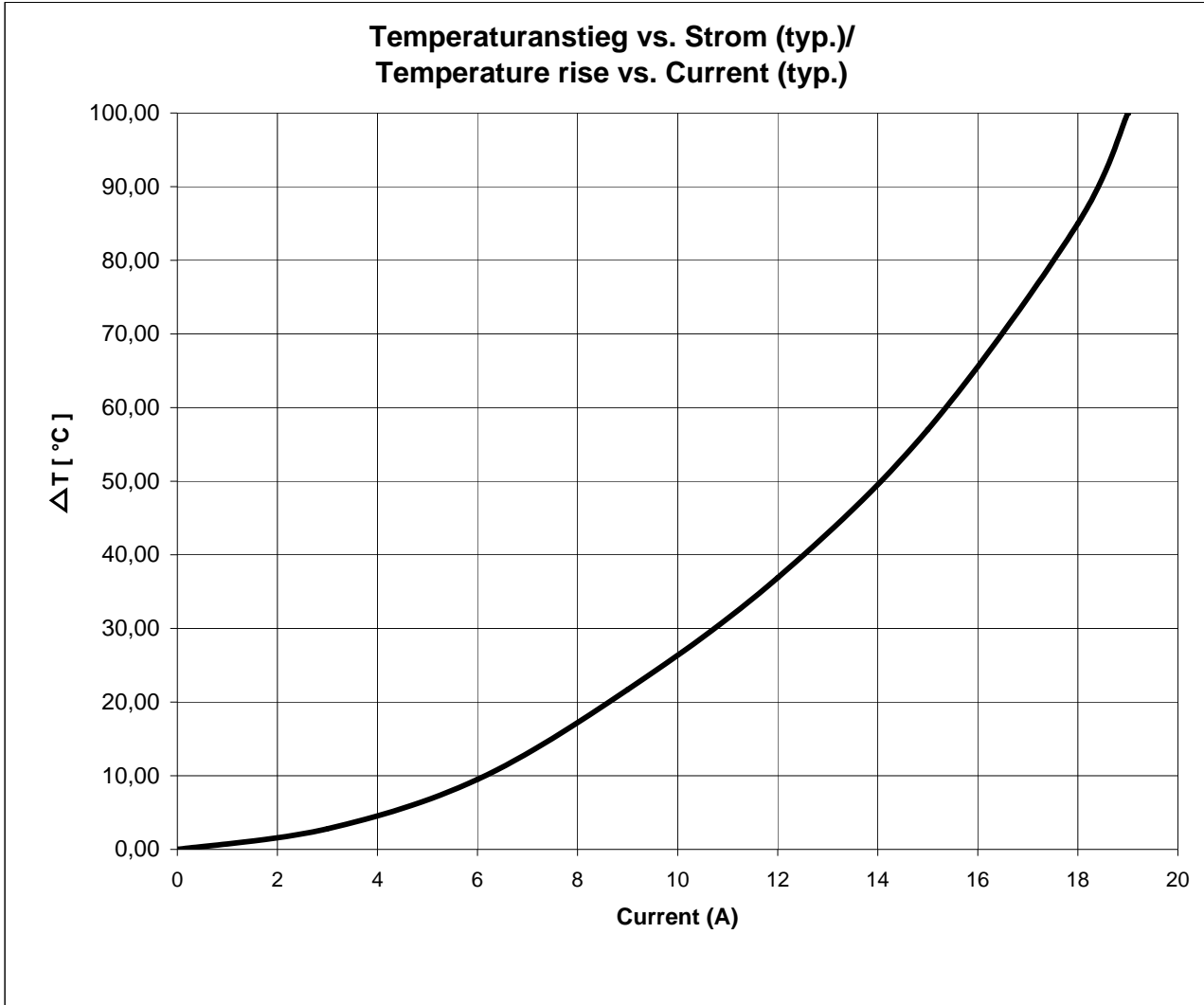

Freigabe erteilt / general release:	Kunde / customer			
Datum / date	Unterschrift / signature			
	Würth Elektronik			
Geprüft / checked	Kontrolliert / approved			
		Name	Änderung / modification	Datum / date
		RST	Version 5	2006-06-02
		ME	Version 4	2005-04-18
		MST	Version 3	2004-10-11
		SST	Version 2	2004-02-02
		JH	Version 1	2000-12-06

Würth Elektronik eiSos GmbH & Co. KG

D-74638 Waldenburg · Max-Eyth-Strasse 1 - 3 · Germany · Telefon (+49) (0) 7942 - 945 - 0 · Telefax (+49) (0) 7942 - 945 - 400
<http://www.we-online.com>

Spezifikation für Freigabe / specification for release

Kunde / customer :
 Artikelnummer / part number : **744324100**
 Bezeichnung : **SPEICHERDROSSEL WE-HC**
 description : **POWER-CHOKE WE-HC**

LF



DATUM / DATE : 2006-06-02

J Rollenspezifikation / tape and reel specification :

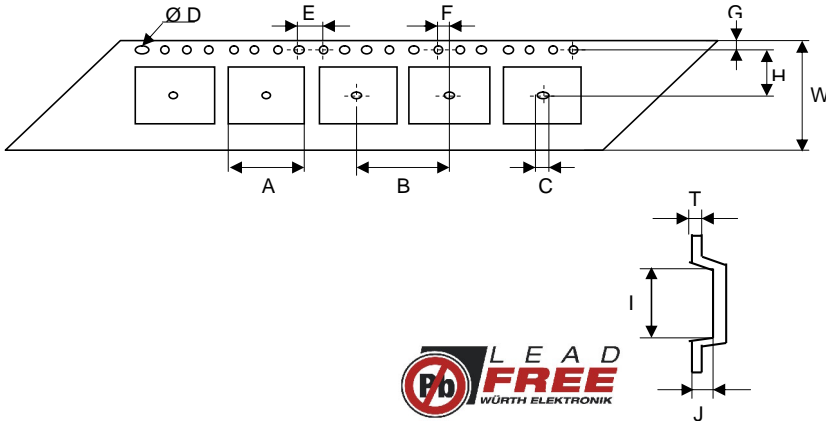

Gurtspezifikation / Tape specification:		
A	10,85 ± 0,1	mm
B	16,0 ± 0,1	mm
C	1,50^{+0,1}_{-0,0}	mm
D	1,50^{+0,1}_{-0,0}	mm
E	4,00 ± 0,1	mm
F	2,00 ± 0,1	mm
G	1,75 ± 0,1	mm
H	11,5 ± 0,1	mm
I	11,65 ± 0,1	mm
J	4,30 ± 0,1	mm
T	0,35 ± 0,05	mm
W	24,0 ± 0,3	mm

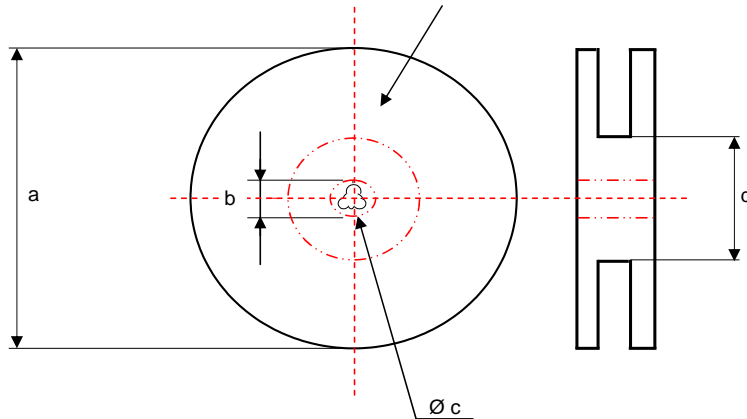

Rollenspezifikation / Reel specification:		
a	330,0 ± 0,5	mm
b	20,20 ± 0,1	mm
c	13,00^{+0,5}_{-1,0}	mm
d	100,0 ± 1,0	mm

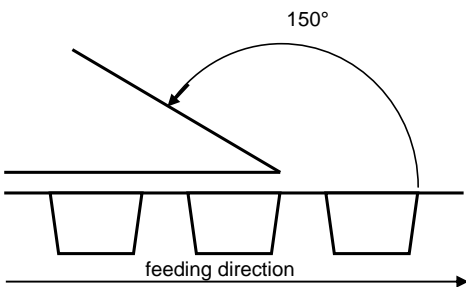

The Force for tearing off cover tape is 20 to 70 grams in arrow direction

Freigabe erteilt / general release:	Kunde / customer				
	Datum / date	Unterschrift / signature	RST	Version 5	06-06-02
Geprüft / checked	Kontrolliert / approved	Würth Elektronik	ME	Version 4	05-04-18
			MST	Version 3	04-10-11
			SST	Version 2	04-02-02
			JH	Version 1	00-12-06
			Name	Änderung / modification	Datum / date

This electronic component has been designed and developed for usage in general electronic equipment. Before incorporating this component into any equipment where higher safety and reliability is especially required or if there is the possibility of direct damage or injury to human body, for example in the range of aerospace, aviation, nuclear control, submarine, transportation, (automotive control, train control, ship control), transportation signal, disaster prevention, medical, public information network etc, Würth Elektronik eiSos GmbH must be informed before the design-in stage. In addition, sufficient reliability evaluation checks for safety must be performed on every electronic component which is used in electrical circuits that require high safety and reliability functions or performance.

Würth Elektronik eiSos GmbH & Co. KG

D-74638 Waldenburg · Max-Eyth-Strasse 1 - 3 · Germany · Telefon (+49) (0) 7942 - 945 - 0 · Telefax (+49) (0) 7942 - 945 - 400
<http://www.we-online.com>