

# Spezifikation für Freigabe / specification for release

Kunde / customer :

Artikelnummer / part number :

**744318120**

LF



Bezeichnung : **SMD HOCHSTROMINDUKTIVITÄT WE-HC**  
 description : **SMD POWER CHOKE WE-HC**

DATUM / DATE : 2005-04-18

## A Mechanische Abmessungen / dimensions :

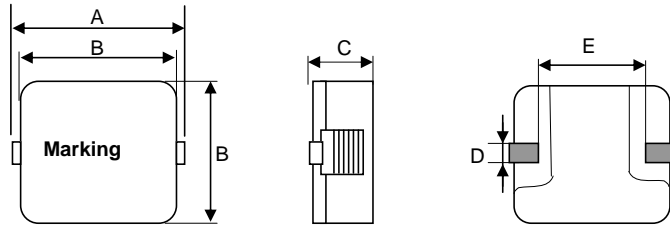

A	<b>14,0 max.</b>	mm
B	<b>12,8 ± 0,3</b>	mm
C	<b>5,3 max.</b>	mm
D	<b>2,3 ref.</b>	mm
E	<b>7,6 ref.</b>	mm
F		mm
G		mm
H		mm

## B Elektrische Eigenschaften / electrical properties :

Eigenschaften / properties	Testbedingungen / test conditions		Wert / value	Einheit / unit	tol.
Induktivität / inductance	<b>100 kHz / 0,1V</b>	$L_o$	<b>1,20</b>	$\mu\text{H}$	$\pm 20\%$
Nenn-Induktivität / rated inductance	<b>100 kHz / 0,1V / 22A</b>	$L_N$	<b>0,90</b>	$\mu\text{H}$	$\pm 20\%$
DC-Widerstand / DC-resistance	<b>@ 20° C</b>	$R_{DC \text{ typ}}$	<b>1,79</b>	$\text{m}\Omega$	<b>typ.</b>
DC-Widerstand / DC-resistance	<b>@ 20° C</b>	$R_{DC \text{ max}}$	<b>2,20</b>	$\text{m}\Omega$	<b>max.</b>
Nennstrom / rated current	<b><math>\Delta T = 50 \text{ K}</math></b>	$I_{DC}$	<b>22,0</b>	A	<b>typ.</b>
Sättigungsstrom / saturation current	<b><math>\Delta L/L_o = -30\%</math></b>	$I_{\text{sat}}$	<b>32,0</b>	A	<b>typ.</b>
Eigenres.-Frequenz / self.res.-frequency		SRF	<b>64,0</b>	MHz	<b>ref.</b>

## C Lötpad / soldering spec. :

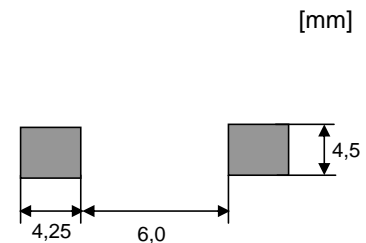

## D Prüfgeräte / test equipment :

**HP 4274 A** für/for L und/and Q  
**HP 34401 A** für/for  $I_{DC}$  und/and  $R_{DC}$

## E Testbedingungen / test conditions :

Luftfeuchtigkeit / humidity: 33%  
 Umgebungstemperatur / temperature: + 25°C

## F Werkstoffe & Zulassungen / material & approvals :

Kernmaterial / core material: WE-Superflux 200  
 Draht / wire: Flatwire/ Flachdraht UL94-V0; 2UEWF 155°C

## G Eigenschaften / granted properties :

Arbeitstemperatur / operating temperature: -40°C - +150°C  
 Umgebungstemp. / ambient temperature: -40°C - +100°C  
 It is recommended that the temperature of the part does not exceed 150°C under worst case operating conditions.

Freigabe erteilt / general release:	<b>Kunde / customer</b>		
Datum / date	<b>Unterschrift / signature</b>		
Geprüft / checked	<b>Würth Elektronik</b>		
Kontrolliert / approved			
Name		Änderung / modification	Datum / date
ME		Version 6	2005-04-18
MST		Version 5	2004-11-09
MST		Version 4	2004-10-11
SST		Version 3	2004-01-27
AG		Version 2	2003-06-11
JH		Neugestaltung	2000-12-06

**Würth Elektronik eiSos GmbH & Co. KG**

D-74638 Waldenburg · Max-Eyth-Strasse 1 - 3 · Germany · Telefon (+49) (0) 7942 - 945 - 0 · Telefax (+49) (0) 7942 - 945 - 400  
<http://www.we-online.com>

# Spezifikation für Freigabe / specification for release

Kunde / customer :

Artikelnummer / part number : **744318120**

LF



Bezeichnung : **SMD HOCHSTROMINDUKTIVITÄT WE-HC**  
 description : **SMD POWER CHOKE WE-HC**

DATUM / DATE : 2005-04-18

## H Induktivitätskurve / Inductance curve :

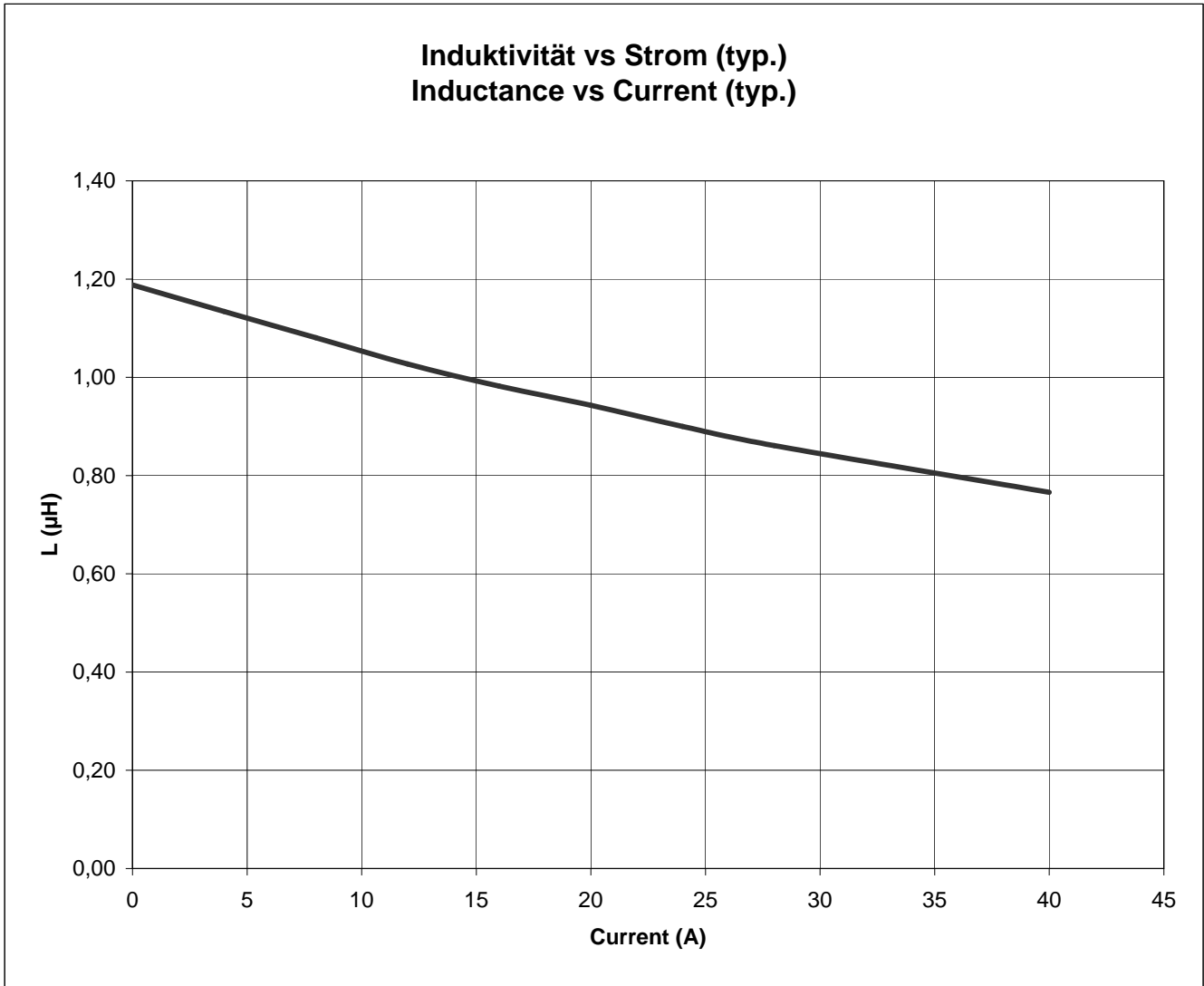

Freigabe erteilt / general release:	<b>Kunde / customer</b>			
		ME	Version 6	2005-04-18
Datum / date	Unterschrift / signature	MST	Version 5	2004-11-09
		MST	Version 4	2004-10-11
		SST	Version 3	2004-01-27
		AG	Version 2	2003-06-11
Geprüft / checked	Kontrolliert / approved	JH	Neugestaltung	2000-12-06
		Name	Änderung / modification	Datum / date

**Würth Elektronik eiSos GmbH & Co. KG**

D-74638 Waldenburg · Max-Eyth-Strasse 1 - 3 · Germany · Telefon (+49) (0) 7942 - 945 - 0 · Telefax (+49) (0) 7942 - 945 - 400  
<http://www.we-online.com>

# Spezifikation für Freigabe / specification for release

Kunde / customer :  
 Artikelnummer / part number :  
 Bezeichnung :  
 description :

**744318120**



## I Temperaturanstieg / Temperature rise curve :

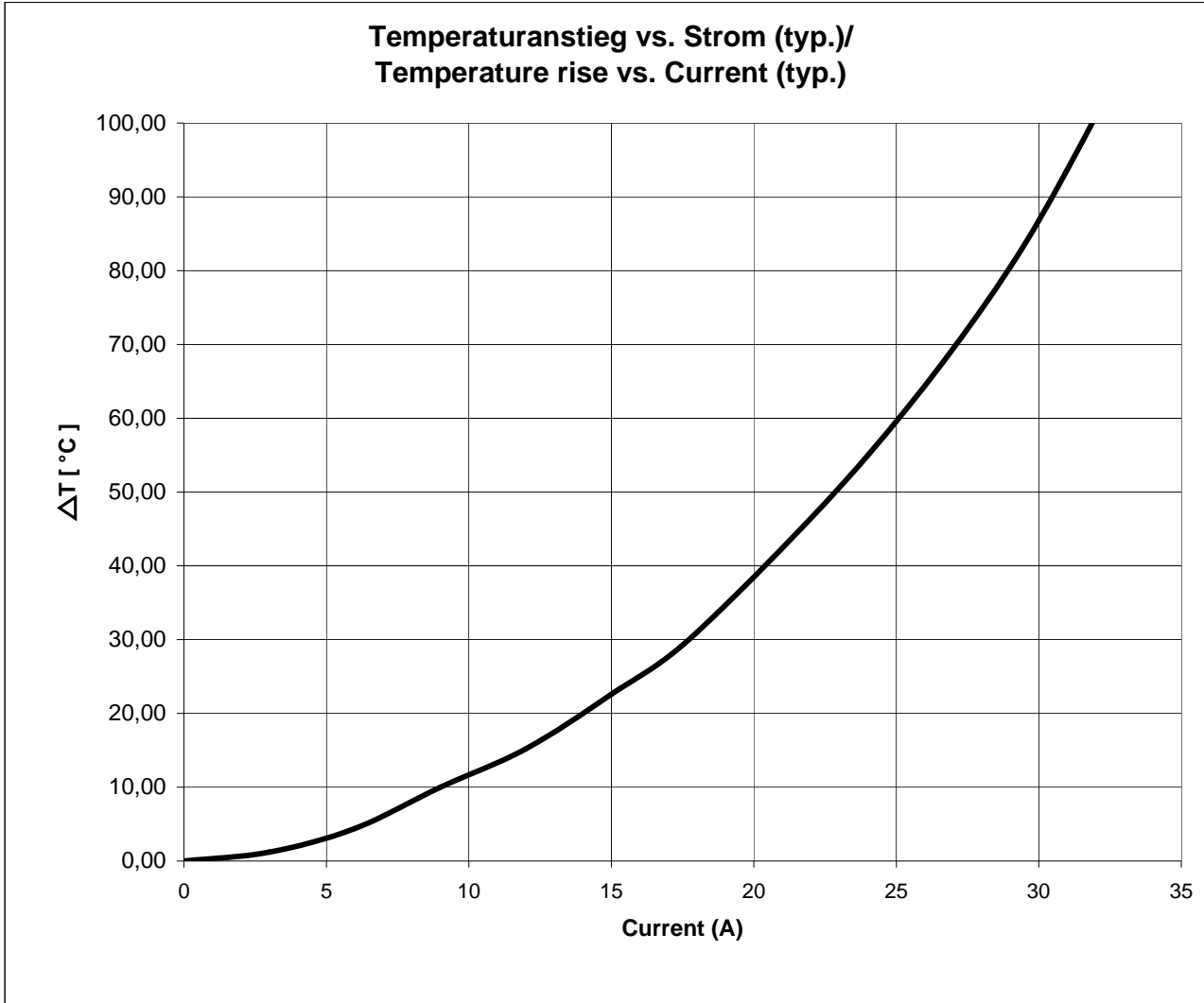

Freigabe erteilt / general release:	<b>Kunde / customer</b>			
Datum / date	Unterschrift / signature	ME	Version 6	2005-04-18
Geprüft / checked	Kontrolliert / approved	MST	Version 5	2004-11-09
		MST	Version 4	2004-10-11
		<b>Würth Elektronik</b>	SST	Version 3
			AG	Version 2
			JH	Neugestaltung
		Name	Änderung / modification	Datum / date

**Würth Elektronik eiSos GmbH & Co. KG**

D-74638 Waldenburg · Max-Eyth-Strasse 1 - 3 · Germany · Telefon (+49) (0) 7942 - 945 - 0 · Telefax (+49) (0) 7942 - 945 - 400  
<http://www.we-online.com>

# Spezifikation für Freigabe / specification for release

Kunde / customer :

Artikelnummer / part number : **744318120**



Bezeichnung : **SMD HOCHSTROMINDUKTIVITÄT WE-HC**  
 description : **SMD POWER CHOKE WE-HC**

DATUM / DATE : 2005-04-18

**J Rollenspezifikation / tape and reel specification :**

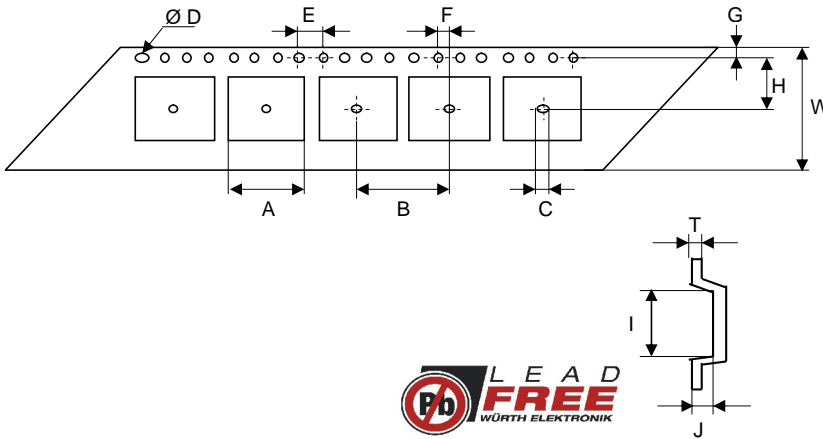

Gurtspezifikation / Tape specification:		
A	<b>13,1 ± 0,1</b>	mm
B	<b>16,0 ± 0,1</b>	mm
C	<b>1,50 ± 0,05</b>	mm
D	<b>1,50 ± 0,05</b>	mm
E	<b>4,00 ± 0,1</b>	mm
F	<b>2,00 ± 0,1</b>	mm
G	<b>1,75 ± 0,1</b>	mm
H	<b>11,5 ± 0,1</b>	mm
I	<b>13,1 ± 0,1</b>	mm
J	<b>5,60 ± 0,1</b>	mm
T	<b>0,35 ± 0,05</b>	mm
W	<b>24,0 ± 0,3</b>	mm

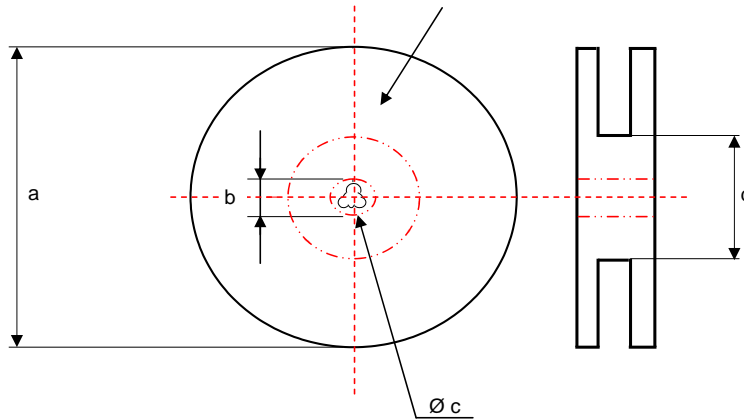

Rollenspezifikation / Reel specification:		
a	<b>330,0 ± 0,5</b>	mm
b	<b>20,20 ± 0,1</b>	mm
c	<b>13,00<sup>+0,5</sup><sub>-1,0</sub></b>	mm
d	<b>100,0 ± 1,0</b>	mm

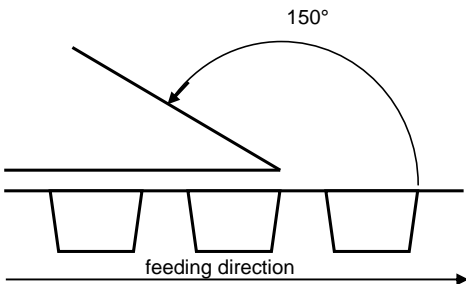

The Force for tearing off cover tape is 20 to 70 grams in arrow direction

Freigabe erteilt / general release:	Kunde / customer			
Datum / date	Unterschrift / signature	ME	Version 6 05-04-18	
		MST	Version 5 04-11-09	
Geprüft / checked	Kontrolliert / approved	Würth Elektronik	MST	Version 4 04-10-11
			SST	Version 3 04-01-27
		AG	Version 2 03-06-11	
		JH	Neugestaltung 00-12-06	
		Name	Änderung / modification Datum / date	

This electronic component is designed and developed with the intention for use in general electronics equipments. Before incorporating the components into any equipments in the field such as aerospace, aviation, nuclear control, submarine, transportation, (automotive control, train control, ship control), transportation signal, disaster prevention, medical, public information network etc. where higher safety and reliability are especially required or if there is possibility of direct damage or injury to human body. In addition, even electronic component in general electronic equipments, when used in electrical circuits that require high safety, reliability functions or performance, the sufficient reliability evaluation-check for the safety must be performed before use. It is essential to give consideration when to install a protective circuit at the design stage.

**Würth Elektronik eiSos GmbH & Co. KG**

D-74638 Waldenburg · Max-Eyth-Strasse 1 - 3 · Germany · Telefon (+49) (0) 7942 - 945 - 0 · Telefax (+49) (0) 7942 - 945 - 400  
<http://www.we-online.com>