



*Process sealed—withstands soldering and cleaning processes.

A



ET01SD1CBE



ET21MD1ABE



ET01MD1AVBE



ET21MD1V3BE

models available, see page A-39.

Easy Build-A-Switch

Below is a complete listing of available options for ET SERIES SEALED TINY TOGGLE SWITCHES. Build-A-Switch allows you to mix and match options to create the switch you need—simply select desired option from each category. Switches with standard options are shown on page A-39; all available options are shown and described on pages A-39 thru A-44. When building a part number, some ordering format boxes may not be filled. Dashes, hyphens or spaces in the part number are not significant, and are shown for clarity only. Complete HOW TO ORDER information is at the end of this section, page A-44. Hardware and accessories are available separately, see section K. All models are process sealed to withstand machine soldering temperatures and pressure wash cleaning methods. ET Series surface mount models also available—see pages A-45 and A-46.

SWITCH FUNCTION	ACTUATOR	BUSHING	TERMINATIONS	CONTACT MATERIAL	SEAL	ACTUATOR COLOR
				Gold	Epoxy	Black
[] [] [] []	[] [] [] []	[] [] [] []	[] [] [] []	[]	[]	[]
ET01	L	C1	A	B	E	(NONE)
ET02	L40	D1	AV	G		1
ET03	L41	F1	AV1	K		2
ET05	M		C	L		3
ET07	M3		V3	M		
ET08	S		V31	Q		
ET21	S1		W			
ET23						
ET24						
ET25						
ET27						
ET28						



*Process sealed—withstands soldering and cleaning processes.

SWITCHES WITH STANDARD OPTIONS

A

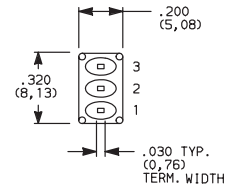
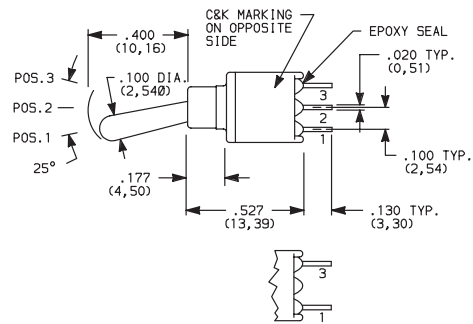
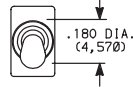

Terminal Nos. For Reference Only

SPST and SPDT Models

Part No. Shown: ET01SD1CBE

ET02 Models: Omit terminal 2.

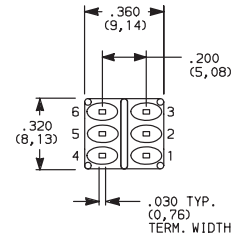
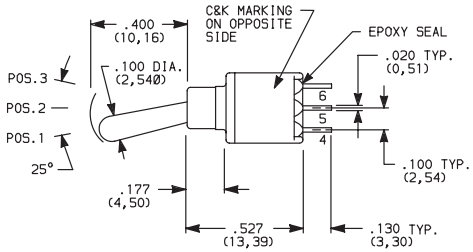
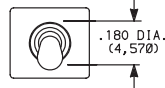

Terminal Nos. For Reference Only

DPDT Model

Part No. Shown: ET21SD1CBE

SWITCH FUNCTION

NO. POLES	MODEL NO.	SWITCH FUNCTION			CONNECTED TERMINALS			SCHEMATIC
		POS. 1	POS. 2	POS. 3	POS. 1	POS. 2	POS. 3	
SP	ET01	ON	NONE	ON				
	ET03	ON	OFF	ON	2-3	OPEN	2-1	
	ET05	MOM.	OFF	MOM.				
	ET07	ON	OFF	MOM.				
	ET08	ON	NONE	MOM.				
	ET02	OFF	NONE	ON	OPEN	N/A	3-1	
DP	ET21	ON	NONE	ON				
	ET23	ON	OFF	ON	2-3,5-6	OPEN	2-1,5-4	
	ET25	MOM.	OFF	MOM.				
	ET27	ON	OFF	MOM.				
	ET28	ON	NONE	MOM.				
	ET24**	ON	ON	ON	2-3,5-6	2-3,5-4	2-1,5-4	

MOM. = Momentary

** Wiring for 3-way switch, see page X.

All models with all options (except M3 actuator) when ordered with G, L, M or Q contact material.

See AGENCY APPROVALS, page VIII.





*Process sealed—withstands soldering and cleaning processes.

TERMINATIONS

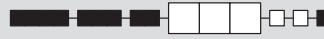

A

C

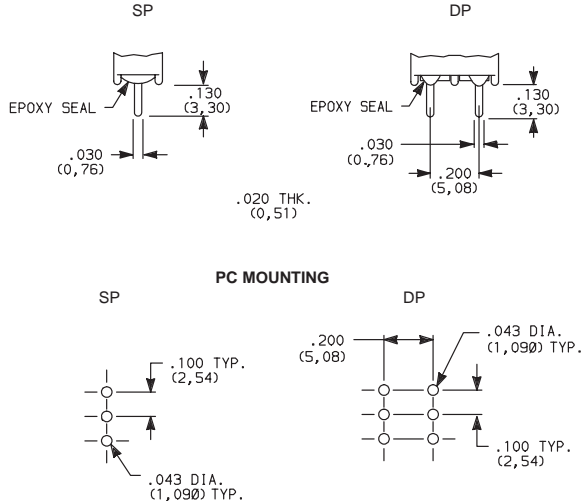

SP and DP Models

NOTE: B contact material standard. Not available with F1 conductive bushing.

W WIRE WRAP

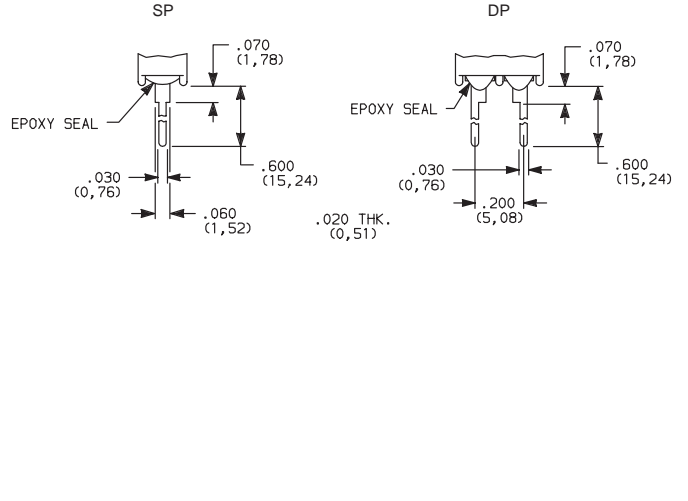

SP and DP Models

NOTE: B contact material standard. Not available with F1 conductive bushing.

A

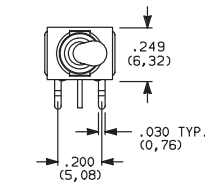

SPDT Model

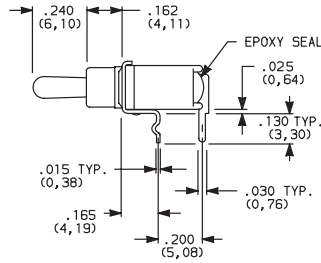

Part No. Shown: ET01MD1ABE

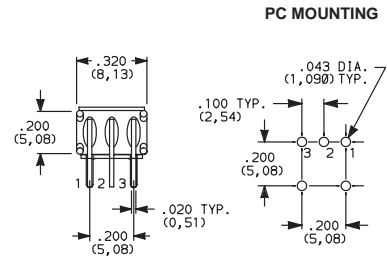

NOTE: B contact material standard. Not available with ET02 model.

A

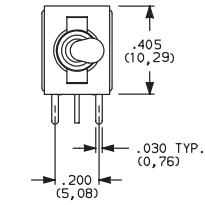

DPDT Model

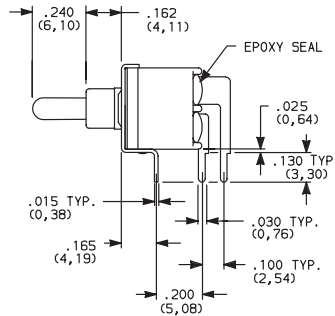

Part No. Shown: ET21MD1ABE

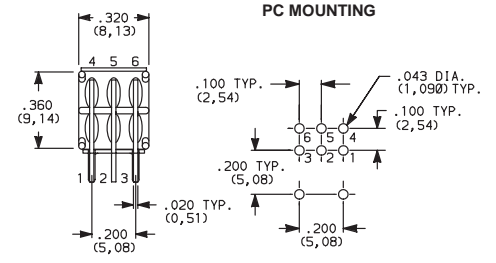

NOTE: B contact material standard.

*Process sealed—withstands soldering and cleaning processes.

A

TERMINATIONS

AV

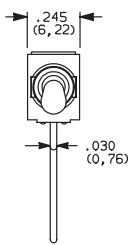

Actuator Shown In Pos. 1

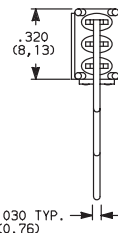
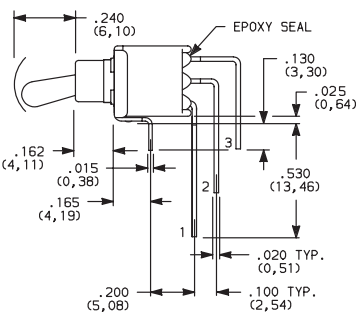

Terminal Nos. For Reference Only

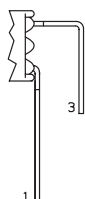
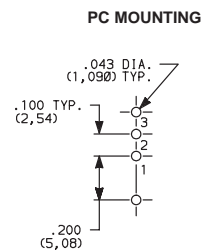

ET02 – omit terminal 2.

SPST and SPDT Models

Part No. Shown: ET01MD1AVBE

NOTE: Terminal bend radii and lead-in manufacturing option. B contact material standard.

AV

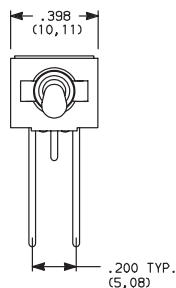

Actuator Shown In Pos. 1

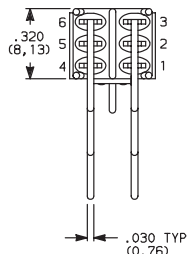
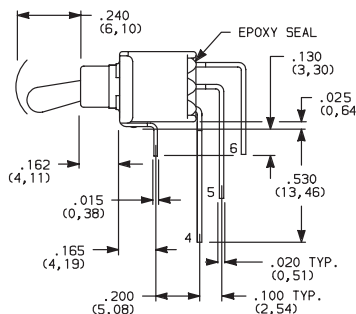

Terminal Nos. For Reference Only

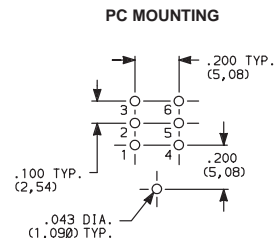

DPDT Model

Part No. Shown: ET21MD1AVBE

NOTE: Terminal bend radii and lead-in manufacturing option. B contact material standard.

AV1

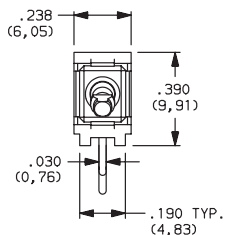

Actuator Shown In Pos. 1

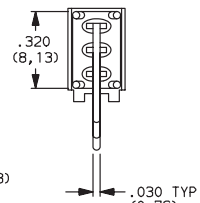
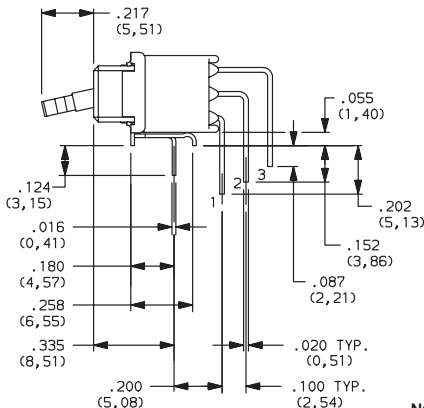

Terminal Nos. For Reference Only

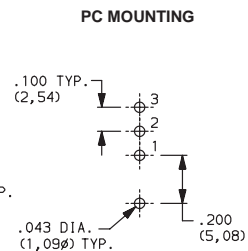

SPDT Model

Part No. Shown: ET01L40C1AV1BE

NOTE: Terminal bend radii and lead-in manufacturing option. Available with ET0X models, L40 & L41 actuators, C1 bushing, B contact material only.



*Process sealed—withstands soldering and cleaning processes.

A

TERMINATIONS

V3
V31 SNAP-IN

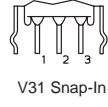
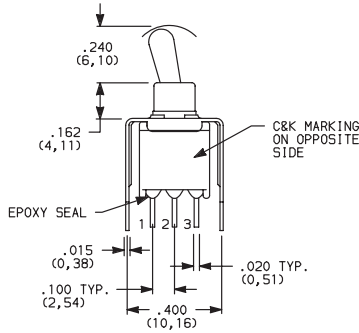

Actuator Shown In Pos. 1
Terminal Nos. For Reference Only
ET02 Models: Omit terminal 2

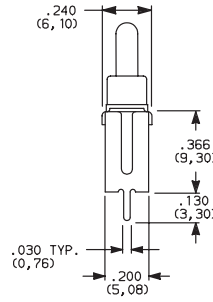

PC MOUNTING

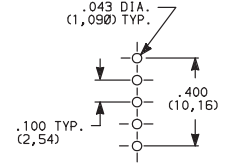

ET02 Models: Omit center hole.

SPST and SPDT Models

Part No. Shown: ET01MD1V3BE

NOTE: B contact material standard.

V3

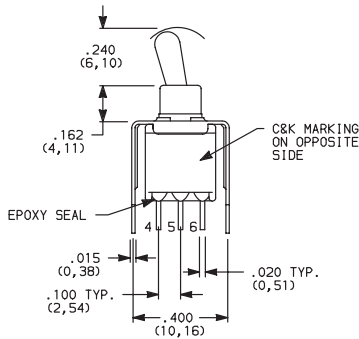

Actuator Shown In Pos. 1
Terminal Nos. For Reference Only

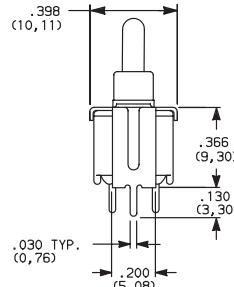

PC MOUNTING

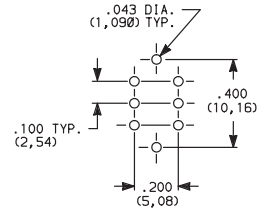

DPDT Model

Part No. Shown: ET21MD1V3BE

NOTE: B contact material standard.

CONTACT MATERIAL

OPTION CODE	CONTACT MATERIAL	TERMINAL PLATING	RATINGS	
B	GOLD ¹	GOLD ¹	LOW LEVEL / DRY CIRCUIT	0.4 VA MAX. @ 20 V AC OR DC MAX.
K		TIN-LEAD ⁶		
Q	SILVER ^{4,5}	SILVER ⁵	POWER	ETX1 MODELS: 3 AMPS @ 120 V AC OR 28 V DC. ALL OTHER MODELS: 2 AMPS @ 120 V AC OR 28 V DC.
M		TIN-LEAD ⁶		
G	GOLD OVER SILVER ^{2,3}	GOLD ³	LOW LEVEL / DRY CIRCUIT OR POWER	ETX1 MODELS: 0.4 VA MAX. @ 20 V AC OR DC MAX. OR 3 AMPS @ 120 V AC OR 28 V DC. ALL OTHER MODELS: 0.4 VA MAX @ 20 V AC OR DC MAX. OR 2 AMPS @ 120 V AC OR 28 V DC.
L		TIN-LEAD ⁶		

CONTACT MATERIAL / APPLICATION RECOMMENDATIONS—SEE CHART, PAGE X.

¹ CONTACTS & TERMINALS: Copper alloy, with gold plate over nickel plate.
² END CONTACT Coin silver, with gold plate over nickel plate.
³ CENTER CONTACTS & ALL TERMINALS: Copper alloy, with gold plate over nickel plate.
⁴ END CONTACTS: Coin silver, silver plated.
⁵ CENTER CONTACT & ALL TERMINALS: Copper alloy, silver plated.
⁶ TERMINALS: Copper alloy, with tin-lead alloy over nickel plate.

All models with all options (except M3 actuator) when ordered with G, L, M or Q contact material.
See AGENCY APPROVALS, page VIII.

B contact material standard with all terminations.

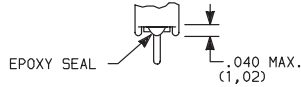
SEAL **E** (STD.)**HOW TO ORDER**

All available ET SERIES SEALED TINY TOGGLE SWITCH options are listed on page A-38 and are described on pages A-39 thru A-44. Switches with standard options are shown on page A-39. When selecting options and building a part number, some ordering format boxes may not be filled. Dashes, hyphens or spaces in the part number are not significant and are shown for clarity only.

SPECIFICATIONS

CONTACT RATING: 0.4 VA max. @ 20 V AC or DC max.
(B contact material).

ELECTRICAL LIFE: E1XX and ETX1 models: 60,000 make-and-break cycles at full load. All other models: 30,000 cycles.

CONTACT RESISTANCE: Below 20 milliohms typ. initial @ 2–4 V DC, 100 mA, for both silver and gold plated contacts.

INSULATION RESISTANCE: 10^9 ohms min.

ELECTROSTATIC DISCHARGE (ESD) RESISTANT OPTION:
M3 insulating actuator only: 9,000 V DC min. @ sea level, actuator to terminals. F1 conductive bushing only: Dissipates up to 20,000 V DC from actuator to ground. M3 actuator and F1 bushing options are not recommended for use together.

DIELECTRIC STRENGTH: 1000 V RMS min. @ sea level.

OPERATING TEMPERATURE: -30°C to 85°C .

SOLDERABILITY: Per MIL–STD–202F method 208D, or EIA RS-186E method 9 (1 hour steam aging).

MATERIALS

CASE & BUSHING: Glass filled nylon 6/6, flame retardant, heat stabilized (UL 94V-0). F1 conductive bushing option is impregnated with carbon fibers.

ACTUATOR: M3 anti-static actuator: Nylon 4/6, black standard (UL 94V-0). All other actuators: Brass, chrome plated. Internal o-ring seal standard with all actuators.

SWITCH SUPPORT: Brass, tin plated.

CONTACTS & TERMINALS: Copper alloy, with gold plate over nickel plate (B contact material).

TERMINAL SEAL: Epoxy.

NOTE: Specifications and materials listed above are general specifications for switches with standard options. For information on specific and custom switches, consult factory.